

SUGGESTED UNIT COURSE IN

SHAPER

Work

FOR BEGINNERS IN
MACHINE SHOP PRACTICE

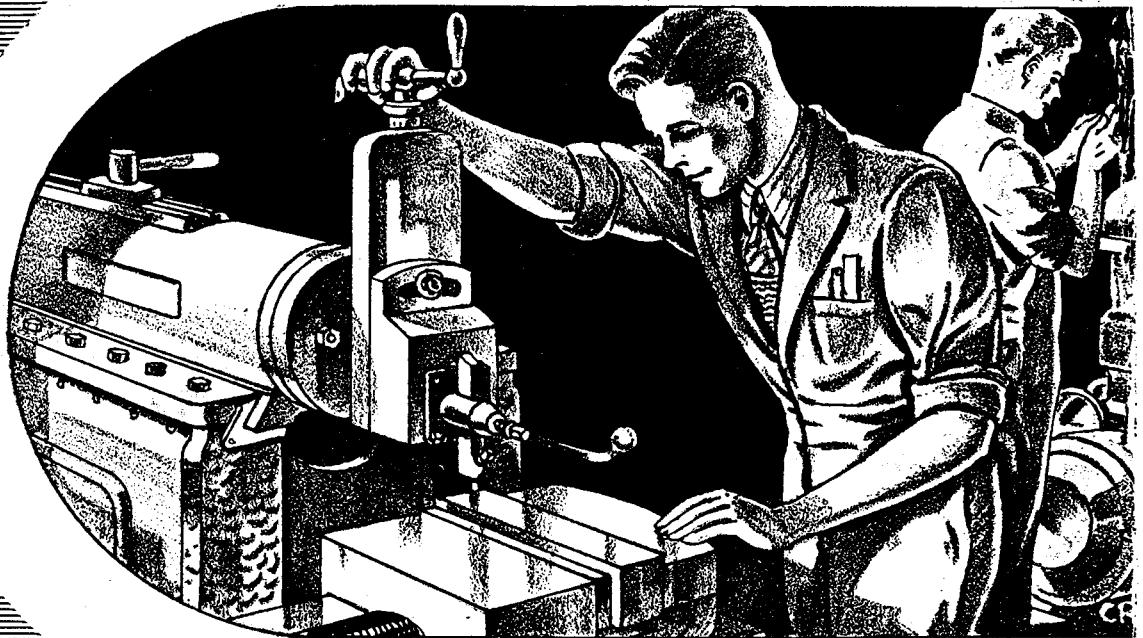

VOCATIONAL
TRAINING FOR
WAR
PRODUCTION
INDUSTRIES

UNIVERSITY OF THE STATE OF NEW YORK
STATE EDUCATION DEPARTMENT
BUREAU OF INDUSTRIAL AND TECHNICAL EDUCATION

SUGGESTED UNIT COURSE IN



SHAPER
WORK

FOR BEGINNERS IN MACHINE SHOP PRACTICE

PREPARED AT

*Curriculum Construction Laboratory
Seneca Vocational High School*

BUFFALO, N.Y.

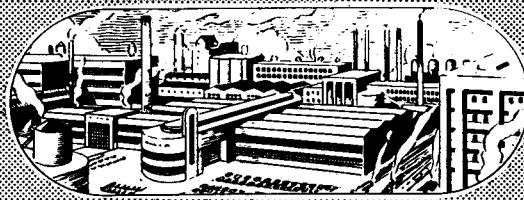

UNIVERSITY OF THE STATE OF NEW YORK
STATE EDUCATION DEPARTMENT
BUREAU OF INDUSTRIAL AND TECHNICAL EDUCATION

THIS MATERIAL WAS PREPARED
IN COOPERATION WITH THE
UNITED STATES OFFICE OF EDUCATION
THE FEDERAL SECURITY AGENCY
WASHINGTON, D.C.

OTHER MONOGRAPHS IN THE MACHINE SHOP SERIES

Bench Work
Lathe Work
Drill Press Work
Milling Machine Work
Heat Treatment of Metals
Job Sheet Series
Applied Mathematics
Machine Shop Measurement
Blue Print Reading for Beginners
Teacher's Manual for Beginners' Course
Advanced Blue Print Reading
Teacher's Manual for Advanced Course

Monographs may be purchased from the New York State
Education Department, 40 Howard Street, Albany, N.Y.
Descriptive circular and price list sent on request.

The New York State Education Department places no
restrictions on the reproduction of any or all of the
material contained in this publication for use by any
war training school that is not conducted for profit,
but no portion of the material may be republished or
reproduced for sale without the written permission of
the copyright owner.

COPYRIGHT 1944
BY THE NEW YORK STATE EDUCATION DEPARTMENT

PREFACE

During the period beginning July 1, 1940 and ending July 31, 1944, the public vocational schools of New York State have furnished pre-employment training to 507,619 inexperienced workers and supplementary training to 577,649. These persons have been trained for employment in such war industries as metalworking and in airplane factories and shipyards of the United States. To meet the need for appropriate instructional material for these workers, the New York State Education Department, through the Bureau of Industrial and Technical Education, organized curriculum laboratories at Rochester, New York City, Buffalo, Cornell University, and Syracuse.

Monographs in the fundamentals of machine shop practice, sheet metal work, aircraft metal work, woodworking, and electricity have been prepared under the direction of the Bureau in cooperation with the U. S. Office of Education. In addition, monographs have been prepared in advanced blue print reading, tool and die design, inspection practice, and advanced electrical work. Instructional material for the training of women to serve as ordnance inspectors, machine operators, and in light assembly practice has also been developed.

Several hundred thousand copies of the books have been distributed to national defense training centers throughout the United States. They have made an important contribution to the effectiveness of our war industries training program.

Acknowledgment is made to school officials and teachers throughout the state for their cooperation in the work of the curriculum laboratories.

Sincere appreciation is expressed to book publishers and industrial concerns for permission to copy or adapt drawings used in the monographs, and to representatives of industry who cooperated in the preparation and criticism of the material.

It is gratifying to note the splendid cooperation which exists between the industries and the vocational schools, manifested in the preparation of instructional material so vital to the war effort.

Lewis A. Wilson
Deputy Commissioner of Education

Oakley Furney
Assistant Commissioner
for Vocational Education

Albany, New York,
October, 1944.

ACKNOWLEDGMENT

This monograph on Shaper Work has been prepared in the Curriculum Construction Laboratory in Seneca Vocational High School, Buffalo, New York, as a part of the New York State program of Vocational Training for War Production Workers under the direction of Oakley Furney, Assistant Commissioner for Vocational Education. This monograph is one of a series of Suggested Unit Courses for Beginners in Machine Shop Practice and is based on the outline developed for this series in the Rochester Curriculum Construction Laboratory under the supervision of Mr. Ewald L. Witzel.

TECHNICAL STAFF ON PREPARATION OF THIS MANUSCRIPT

Frederick Theurer Supervisor, Curriculum
Construction Laboratory
Seneca Vocational High School
Buffalo, New York

Alec P. Armsden Supervisor, Curriculum
Construction Laboratory
Seneca Vocational High School
Buffalo, New York

Charles Rohrbach Illustrator, Curriculum
Construction Laboratory
Seneca Vocational High School
Buffalo, New York

Acknowledgment is made to the officials of the public schools of Rochester, N. Y., and to the machine shop committee who prepared the original material as part of the vocational in-service teacher training courses conducted in cooperation with the Board of Education of the City of Rochester: Arthur Ahr, William Auer, Howard S. Bennett, Willard H. Clark, Joel M. Coryell, Robert Cutter, William J. Darling, Nelson L. Dummer, Herbert B. Eckert, George C. Fisher, George E. Hamalainen, George C. Hasselberg, Fred J. Koser, Stanley Kusak, Charles McCormick, Anthony Metzler, Jr., Harry E. Montgomery, Norman A. Mueller, J. Fred Munger, Arthur W. Neff, Duane B. Osburn, Richard J. Redeman, William W. Rogers, Norbert L. Sanders, Philip D. Sukert, Norbert G. Thibault, Fred M. Tinker, Charles S. Tracy, Harry J. Weniger, and George J. Willig.

Sincere appreciation is also expressed to the members of the Machine Shop Teachers' Guild of New York City, and to Professor Orlan W. Boston, University of Michigan, Chairman of the Standardization Committee in the A.S.M.E., for their cooperation.

Special acknowledgment is made to Robert T. Bapst, Superintendent of Schools, Francis H. Wing, Associate Superintendent of Vocational Education, Richard A. Reagan, Principal, Seneca Vocational High School, Martin H. Kuehn, Director of War Industries Training, Gerald B. Leighbody, Supervisor of Industrial Education, State Education Department, Norman C. Oelheim, Instructor, Seneca Vocational High School, all of Buffalo, N. Y., and to C. Thomas Olivo, Director, State Technical Institute, Schenectady, N. Y., for providing facilities necessary for the completion of the work and for other helpful cooperation.

Some acknowledgments appear in footnote form throughout the text. Additional appreciation is expressed for valuable cooperation of the following manufacturers in providing photographs and technical material for use in this monograph.

American Tool Works Company
Armstrong Bros. Tool Co.
Carborundum Company
Cincinnati Shaper Company
Gould & Eberhardt
Hendey Machine Company
Norton Company
Oilgear Company
"O K" Tool Co. Inc.
Rockford Machine Tool Company
Vickers, Incorporated
Western Machine Tool Works
J. H. Williams & Co.

Cincinnati, Ohio
Chicago, Illinois
Niagara Falls, N.Y.
Cincinnati, Ohio
Irvington, N. J.
Torrington, Conn.
Worcester, Mass.
Milwaukee, Wis.
Shelton, Conn.
Rockford, Illinois
Detroit, Michigan
Holland, Michigan
Buffalo, New York

Albany, New York,
October, 1944.

Eugene D. Fink,
Supervisor of Industrial Education

TO THE TEACHER

This monograph includes a descriptive section designed to introduce the beginner to the crank shaper and to the hydraulic shaper, and to some of the accessories commonly used on these machines. In this section, the individual parts which make up the shaper are named, their use and their operation in relation to each other are explained, and the principles on which various mechanisms work are set forth.

This monograph includes also a procedure in which the unit lessons have been arranged in a Trade Theory Series and a Fundamental Process Series which parallel each other and distinguish between related informational material in the one series, and, in the other, basic or fundamental operations which are common to shaper work in any situation.

The Trade Theory units deal with the basic theory and related informational material for the work, or the "Why to Do."

The Fundamental Process units deal with the manipulative phase of the work, or the "How to Do," and involve the use of tools, machines and accessories.

These units of instruction, written especially for beginners, have been arranged in a sequence in which careful consideration has been given to learning difficulties. They proceed from the simple unit, "How to Shape Horizontal Surfaces," to the more complex unit, "How to Shape Simple Contours."

The instructor may develop lesson plans for related shop talks from the trade theory units. The fundamental process units, in which successive steps in the procedure have been arranged in the generally accepted order, may serve as a guide for shop demonstrations. The concurrent illustrations in both series of units offer valuable assistance to the instructor in making explanations and demonstrations, and to the student in comprehending these processes.

The student should be provided with a copy of this monograph to be used as a text; its possession provides an opportunity to learn the related material and, as a text, it will serve as a guide in the performance of the process after it has been demonstrated.

Actual jobs, rather than exercises, should be used to provide experience in the fundamental processes. The related theory for any given unit also can be taught most effectively when practical applications are used as illustrations.

Frederick Theurer
Alec P. Armsden

TABLE OF CONTENTS

Trade Theory Series

Fundamental Process Series

Unit*	Pages	Unit*	Pages
1-T52(A)		1-P52(A)	
I. DESCRIPTION OF THE		I. HOW TO OIL THE SHAPER	47- 54
CRANK SHAPER	1- 32	Lubrication Chart	52
Base	7		
Column	7	II. HOW TO OPERATE AND CARE	
Cross Rail	8	FOR THE SHAPER	55- 74
Saddle	9	Starting and Stopping	57
Table	10	Controlling Table Movement	59
Table Support	11	Operating Rapid Power Traverse	61
Ram	12	Controlling Ram Movement	63
Tool Head	14	Controlling Movement of the	
Driving Mechanisms	17	Tool Slide	65
Quick Return	19	Taking up Back Lash	66
Stroke-Adjusting Mechanism	20	Caring for the Shaper and	
Speed-Changing Devices	21	its Accessories	67
Feed Mechanism	23		
Bevel Gear Feed Reverse		III. HOW TO ADJUST THE SHAPER	75- 96
Mechanism	27	Position of the Cross Rail	77
Power Rapid Traverse	29	Position of Table	78
Oiling System	29	Length of Stroke (Crank Shaper)	79
		Position of Stroke " "	81
II. DESCRIPTION OF THE HYDRAULIC		Speed of Ram " "	82
SHAPER	33- 46	Cross Feed " "	90
Hydraulic Unit	35	Tool Head	91
Pumps	36	Length of Stroke (Hydraulic ")	92
Valves	42	Position of Stroke " "	92
Cross Feed	45	Speed of Ram " "	94
Power Rapid Traverse	46	Cross & Vertical Feeds" "	95
1-T52(B)		1-P52(B)	
DESCRIPTION OF WORK-		HOW TO MOUNT WORK-HOLDING	
HOLDING DEVICES	97-116	DEVICES	117-150
Vise	99	Mounting the Vise	119
Parallels	104	Dismounting the Vise	122
Shaper Bolts	105	Setting the Vise with	
Straps or Clamps	106	the Aid of Graduations	124
Stops	108	Setting the Vise with	
Toe Dogs	108	the Aid of an Indicator	125
Hold Downs	109	Using Shaper Bolts	135
Aligning Strips	109	Using Straps & Blocking	135
V-Blocks	110	Using Aligning Strips	137
Angle Plate	111	Using Stops	139
C-Clamps	112	Using Toe Dogs	141
Machinist's Clamps	113	Using Hold Downs	142
Jacks	114	Using V-Blocks	143

Unit*	Pages	Unit*	Pages
1-T52(B) continued		1-P52(B) continued	
Shims and Wedges	114	Using Angle Plates,	
Packing and Step Blocks	115	C-Clamps, and Jacks	146
Fixtures	116	Using Machinist's	
Special Vise Jaws	116	Clamps	150
1-T52(C)		1-P52(C)	
I. DESCRIPTION OF SHAPER		I. HOW TO SET UP SHAPER TOOLS	167-172
TOOL HOLDERS	151-156	How to Use Shaper Tools	169
Size and Style	153	Chart of Cutting Tools	
Types of Tool Holders	154	Used for Various	
Clamping Methods	155	Operations	171
II. DESCRIPTION OF SHAPER TOOLS	157-166	II. HOW TO GRIND SHAPER TOOLS	
Cutting-Tool Terminology	158	Omitted - See Unit 1-P54	
Forms of Tools	161		
Clearance, Rake & Lip Angle	163		
Chart of Tool Shapes	166		
1-T53(A)		1-P53(A)	
DESCRIPTION OF HORIZONTAL,		I. HOW TO SHAPE HORIZONTAL	
VERTICAL, AND COMBINED		SURFACES	189-209
CUTS	173-188	Mounting the Work	191
Definitions of Cuts	175	Adjusting the Tool	193
Horizontal Cut	176	Taking the Rough Cut	195
Placement of Stroke	176	Taking the Finish Cut	197
Placement of Work	177	Planing Adjacent Sides	199
Tools for Horizontal Cut	177	Squaring the Ends	202
Requisites of a Good Setup	178	Correcting Inaccuracies	203
Position of Clapper Box	179	Using the Surface Gage	206
Placement of Tool Holder			
and Tool	180	II. HOW TO SHAPE VERTICAL SURFACES	210-219
Direction of Feed	180	Mounting the Work in the	
Roughing Cut	181	Vise	210
Finishing Cut	182	Mounting the Work on the	
Vertical Cut	184	Table	210
Functioning of Clapper Box	186	Adjusting the Tool & Head	213
Combined Horizontal and		Adjusting the Shaper	
Vertical Cuts	187	Prior to the Cut	214
		Taking the Rough Cut	215
		Taking the Finish Cut	218
		III. HOW TO SHAPE COMBINED HORIZON-	
		TAL & VERTICAL SURFACES	220-224
1-T53(B)		1-P53(B)	
DESCRIPTION OF ANGULAR		I. HOW TO PLANE ANGULAR SUR-	
CUTS	225-234	FACES WHEN THE WORK IS	
Explanation of Angular Set-		SET WITH THE SURFACE	
ting of the Tool Head	227	GAGE	235-242

Unit*	Pages	Unit*	Pages
1-T53(B) continued Explanation of Angular Setting of the Vise	231	1-P53(B) continued II. HOW TO CHAMFER A SURFACE WHEN THE TOOL IS SET AT AN ANGLE	243-251
1-T53(C) DESCRIPTION OF SLOTTING, SERRATING, AND SIMPLE FORM CUTTING	259-264	III. HOW TO PLANE AN ANGULAR SURFACE WHEN THE HEAD IS SET AT AN ANGLE	251-258
1-T53(D) DESCRIPTION OF SPEEDS AND FEEDS	293-308	1-P53(C) I. HOW TO CUT OFF & CUT SLOTS	265-278
Shaper Speeds	295	II. HOW TO CUT SERRATIONS	279-285
Cutting Speeds	299	III. HOW TO SHAPE SIMPLE CONTOURS	285-292
Cutting Speed Formulas	300	1-P53(D) HOW TO ADJUST THE SHAPER	Omitted - See Unit 1-P52(A)
Shaper Speed Formula	303		
Description of Feed	304		
Calculating Cutting Time	306		
Table of Cutting Speeds	308		
1-T54 I. DESCRIPTION OF THE BENCH OR FLOOR GRINDER	309-312	1-P54 I. HOW TO USE THE BENCH OR FLOOR GRINDER	315-322
		Mounting a Wheel	318
		Removing a Wheel	318
		Adjusting the Grinder Prior to Operating	320
		Dressing a Wheel	321
II. DESCRIPTION OF GRINDING WHEELS	312-314	II. HOW TO GRIND SHAPER TOOLS	322-326
Natural Abrasives	313	The Roughing Tool	322
Artificial Abrasives	313	Stoning the Tool	325
Selection of Wheels	314		

* Key to Unit Numbers

1- First year or beginner level
(-P Fundamental Process Series

(-T Trade Theory Series
52 Sequence of Units of Instruction

Example:

1-T52 First Year Machine Shop Practice
Trade Theory Unit Number Fifty-two

DESCRIPTION of the CRANK SHAPER

OBJECTIVES OF UNIT

1. To explain how metal is removed in the shaper.
2. To point out several types of metal shapers.
3. To name and describe the main parts of a mechanically driven crank shaper.
4. To indicate the functions of these parts.

INTRODUCTORY INFORMATION

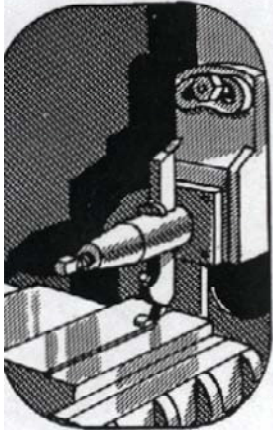

The shaper is a machine tool used to machine a flat surface which may be in a horizontal, a vertical, or an angular plane. In addition, the shaper is used to machine odd and irregular shapes which would be difficult to produce on other machines.

The work is held on an adjustable worktable or, if its size and shape permit, in a vise which in turn is bolted to the table.

A single-point cutting tool attached to a rigid arm called the ram moves over the work with a reciprocating (alternate forward and backward) motion. The length of the ram stroke and the number of strokes per minute may be varied as the length of the work and its composition change.

With one exception, the cutting tool, which is adjustable vertically, removes material during the forward stroke only. During the return stroke of the ram, the table and the work move toward the tool a predetermined amount as long as the automatic table feed remains engaged.

Most shapers have been designed with a vertical column or pillar which is used to support the ram, the table, and the drive and feed mechanisms, and therefore at one period in their development were called column or pillar shapers.

However, since the column-type of design has become so generally used in shaper construction, manufacturers have assumed that this

fact has become commonly known in the machine industry and therefore have used instead more specific and meaningful terms in classifying their machines, terms which indicate or emphasize some characteristic features in the design of their product.

Several more or less commonly used types of shapers are manufactured. Each class has been designed to perform a definite class of shaper work with the greatest possible effectiveness.

Among the less common designs are the traveling-head shaper and the draw-cut shaper. The classification of these machines has been influenced by the action of the machine during its operation. For example, in the traveling-head machine, contrary to general procedure, the ram and the tool, instead of the work, move when the automatic feed has been engaged, and, in the draw-cut shaper, material is removed on the return stroke of the ram, instead of on the forward stroke as is the case with other types of shapers.

In another group of shapers, classification has been based on the type of driving mechanism utilized in their construction. For instance, shapers in which the back-and-forth movement of the ram is brought about by a crank pin in the main driving gear of the machine, have been designated crank shapers.

Similarly, geared shapers have been so called because a series of gears and a rack attached to the underside of the ram, move the tool over the work.

TRAVELING HEAD SHAPER

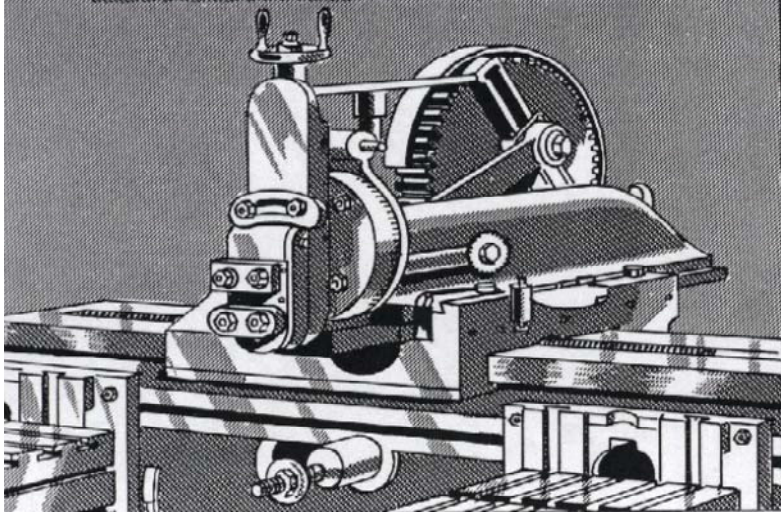

DRAW-CUT SHAPER

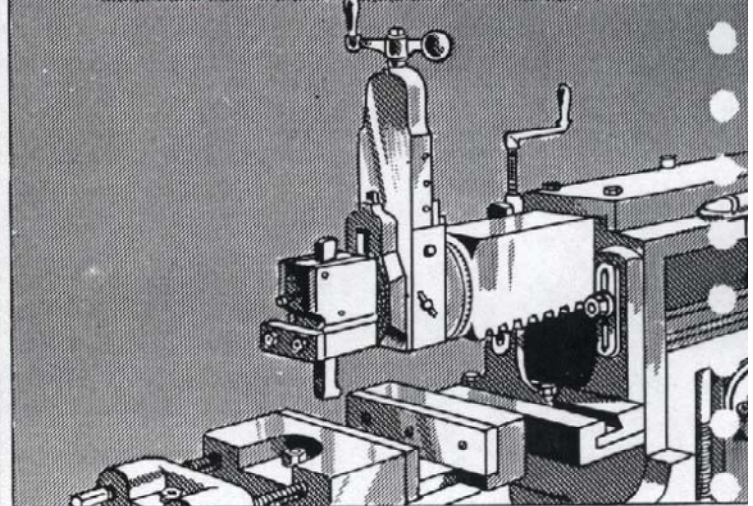

In the vertical shaper, still another constructional feature of its design is responsible for its name. In machines of this type, the tool moves in a vertical direction in contrast to the usual horizontal movement of the ram on the other types of shapers mentioned.

The size of a shaper is designated by the maximum length of its stroke given in inches. This length of stroke may range from 6 inches on a bench-type shaper to 36 inches on a heavy-duty machine, and indicates, in addition to the size of the machine, the dimensions of a cube which can be held and planed in a shaper of a known size.

A 16-inch shaper, for example, can be adjusted for any ram stroke from 0"-16" in length, the transverse table feed can be used to plane a surface 16 inches wide, and the vertical distance between the tool head and the worktable in its extreme lower position will be sufficient to permit planing the upper surface of a 16-inch cube resting on the table.

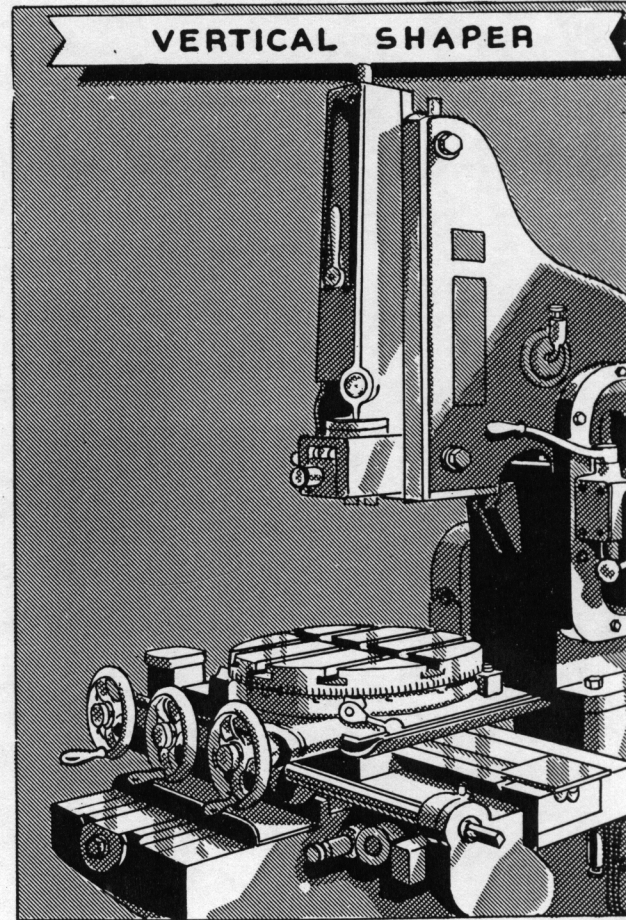

The crank shaper of the vertical-column construction is the type most commonly used in machine shops and tool rooms. Shapers in this classification are manufactured in universal models on which the table may be adjusted to angular positions, and also in plain models on which the table, however, has no facilities for angular shaping. This monograph will be confined to the description of the plain crank shaper and to an explanation of some of the operations which can be performed on a shaper of this type.

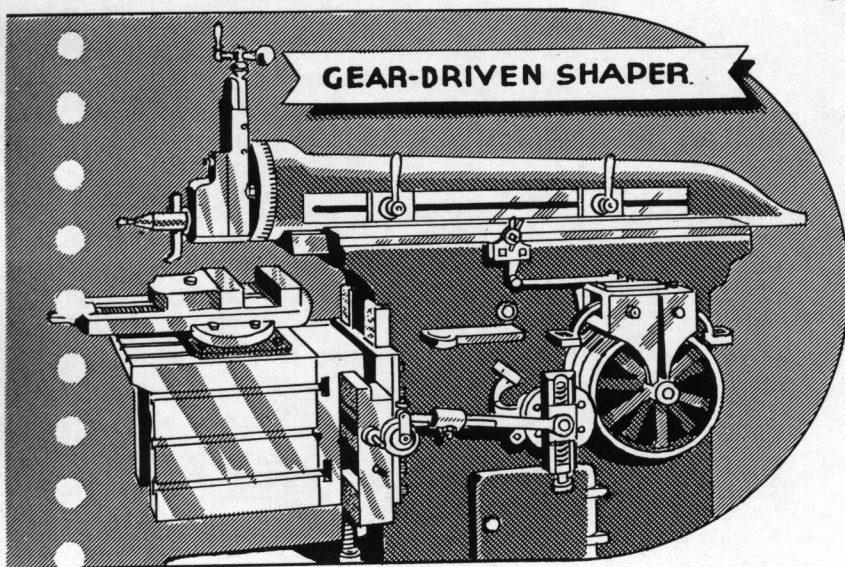

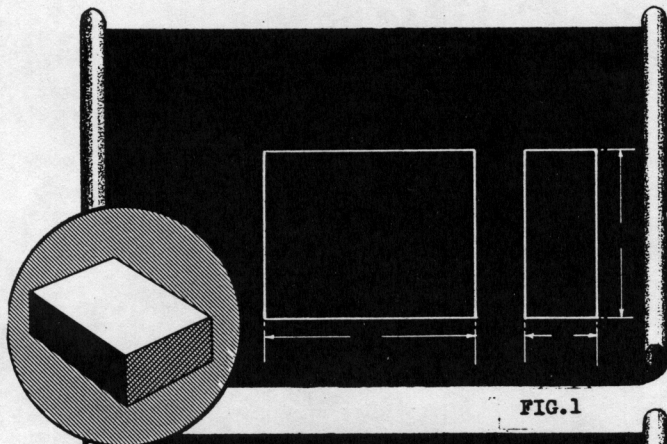

FIG. 1

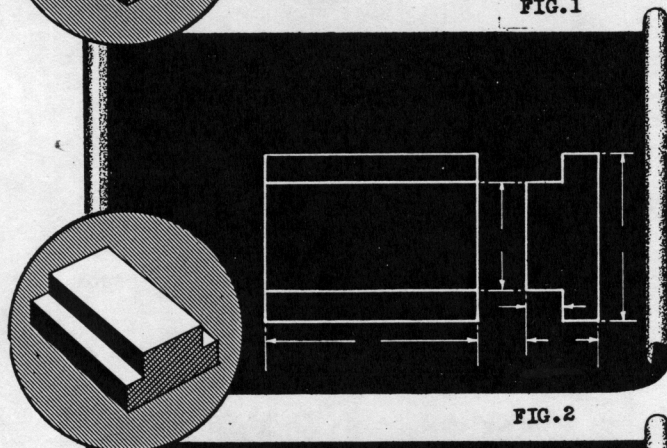

FIG. 2

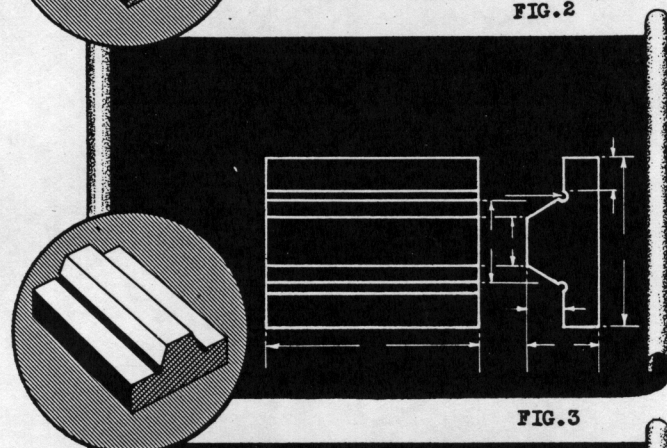

FIG. 3

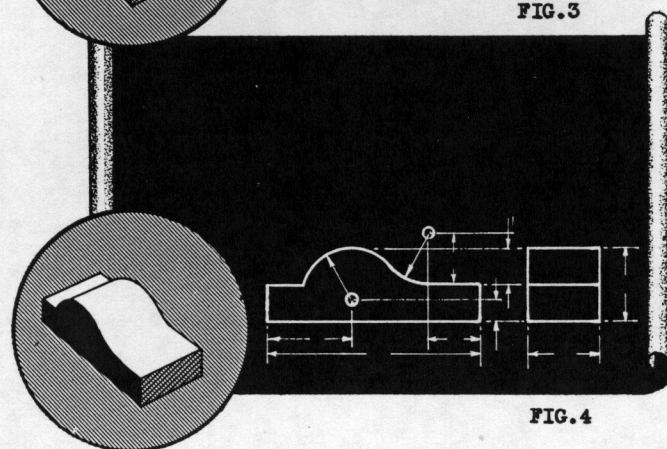

FIG. 4

A few jobs involving operations which are typical of those frequently performed in the shaper have been illustrated on this page. They give some idea of the wide variety of work which may be performed by an operator who is familiar with the construction of the shaper and who understands the principles of its operation.

One of the simplest shaper operations is that of machining a casting to definite dimensions by removing one or more cuts from its surfaces, the surfaces to be placed horizontally during the cut and the job to be held in the vise as indicated in Fig. 1.

Frequently a surface can be machined to better advantage when it is placed in a vertical position and the tool fed down along a vertical surface of the work instead of across a horizontal surface of the work. Fig. 2 shows this kind of setup.

Shaping the work at an angle other than 90° from the machine table closely resembles vertical cutting, but such a machining process involves adjustment of the tool head to a position corresponding to the angle required on the work. This setup has been illustrated in Fig. 3.

Both lateral movement of the table and vertical movement of the tool are required when it becomes necessary to shape an irregular layout such as the one shown in Fig. 4.

The cutting of slots, keyways, and dovetails are other operations which can readily be performed in the shaper.

The bottom of the column rests on surface A of the base casting. The upper surface forms the guide ways for the ram. Either one or both of the V-shaped guide ways B may be cast as an integral part of the column, but different methods for taking up wear between these surfaces and the ram must be provided for each form of construction.

When both ram ways form a permanent part of the column, a taper gib inserted between the ram and its ways provides a means of adjustment between these parts. Where only one ram way has been cast to the column, the second guide C is bolted thereto, thus permitting its position to be changed with a series of screws D when it becomes desirable to alter the adjustment between the ram and its ways. (Refer to page 12.)

The front vertical face of the column has been accurately planed at right angles to the ram ways on the top. This face and the T-ways adjacent thereto on both sides, keep the cross rail in its proper horizontal relationship with the ram when the cross rail must be moved vertically on the face of the column.

The convex wall F on the right side of the shaper column provides space internally for the main driving gear and externally supports the stroke-adjusting mechanism and the table feed unit.

A large opening in the left side of the column allows access to its interior for repairs and adjustments. A cover over this opening excludes foreign material and prevents accidental contact with the moving parts enclosed in the column.

Another opening located at the top of the column and in the center of the front face is called the throat E. When a shaping operation is to be performed near the end of a long piece of work, it may be extended into this opening in the column. A guard keeps chips from the throat when it is not in use.

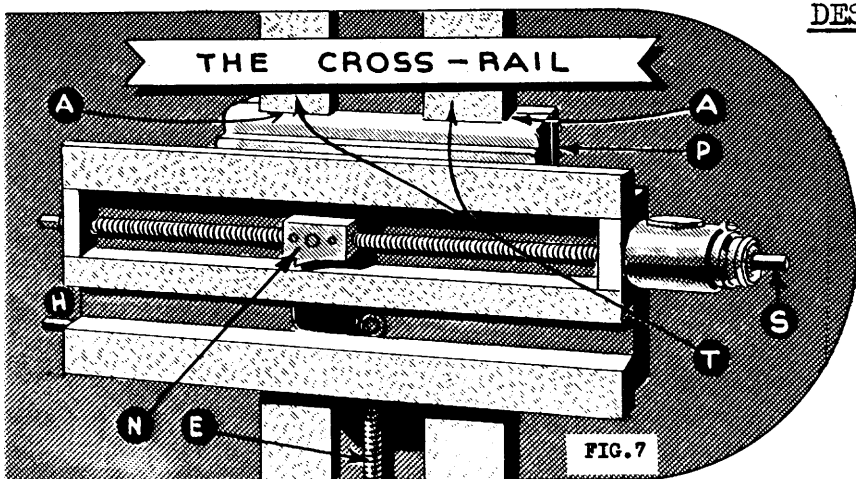

DESCRIPTION OF THE CROSS RAIL

The cross rail is a relatively long casting located across the front of the column. Its function is to permit vertical and horizontal movement of the table.

Opening A fits around the front and sides of the vertical surfaces on the column, and, together with plates P, forms the bear-

ing surfaces which permit the cross rail to be adjusted vertically to provide for jobs which may vary considerably in height.

Plates P are bolted to the back of the cross rail and extend behind the T-shaped ways T which form part of the column face.

The gib between the side of the column and the cross rail keeps these parts in adjustment sideways. Hexagon-head bolts, or often handles, are provided on both sides of the shaper to bind the cross rail to the column immovably.

An elevating screw E controls the vertical movement of the cross rail and determines its position on the column. When it becomes necessary to change the height of the cross rail, motion, applied by means of a crank at the squared end of the horizontal shaft H, is transmitted through bevel gears within the rail to the elevating screw or to a nut mounted thereon.

Just as the front face of the column furnishes the bearing surface for the cross rail so, in turn, the front face of the cross rail serves in a similar capacity for the saddle, but with this difference: the column face provides for vertical movement of the table, whereas the face of the cross rail controls horizontal movement of this part.

A cross-feed screw S, mounted horizontally in the cross rail, extends from end to end, and, by passing through a stationary nut N, attached to the rear of the saddle, controls the sidewise movement of this part. A crank may be used on the end of the screw to feed the saddle, together with the table, by hand.

A metal guard (not shown) protects the bearing surfaces of the cross rail from damage, and bronze retainers with felt inserts or wipers remove dirt and fine particles of metal from its working surfaces while adjustment is being made.

DESCRIPTION OF THE SADDLE

The saddle, or apron, which is a comparatively thin, flat casting located between the cross rail on one side and the worktable on the other, forms the connecting link between these parts.

The rear of the saddle fits the horizontal guide ways A on the cross rail. These guide ways generally consist of a dovetail fit at the bottom and a

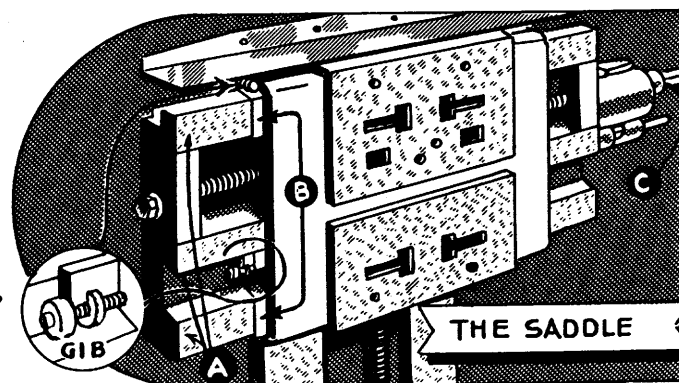

FIG. 8

DESCRIPTION OF THE SHAPER

The parts of the shaper will be described in the order in which these parts or units might be brought together for assembly of the machine.

DESCRIPTION OF THE BASE

The base, which rests directly on the shop floor, is a casting which serves as a foundation for the entire machine. After being leveled, the machine may be fastened securely with foundation bolts inserted through holes provided for this purpose near the outer edge of the base.

The portion of the base beneath the column is utilized as an oil reservoir when the machine has been equipped with a pressure-lubricating system; that portion of the base not so used is hollow underneath and braced with internal ribs spaced at intervals designed to strengthen the casting.

The only places which have been machined on the base casting are surface A, to which the column will be bolted, pad B, which forms a flat bearing surface for the table support, and hole C, which centers the lower end of the table elevating screw. All other surfaces are unfinished.

A rim D surrounds the base. This retains excess oil which drips from the machine and prevents the oil from reaching the shop floor.

On some motor-driven machines an extension to the rear of the base casting provides space for the motor; on others, however, the motor is attached to the column or to a separate casting which is bolted to the base.

DESCRIPTION OF THE COLUMN

The column or frame, as it is also called, is a hollow casting shaped like a box with openings at the top and bottom. In addition to enclosing the mechanism which drives the ram, it also houses a unit which actuates the automatic feed, and, in the mechanically driven shaper, another unit which permits adjustment of the ram stroke. Heavy internal ribs keep the column permanently rigid and accurate. Its external surfaces support both the table which holds the work and the ram which holds the cutting tool.

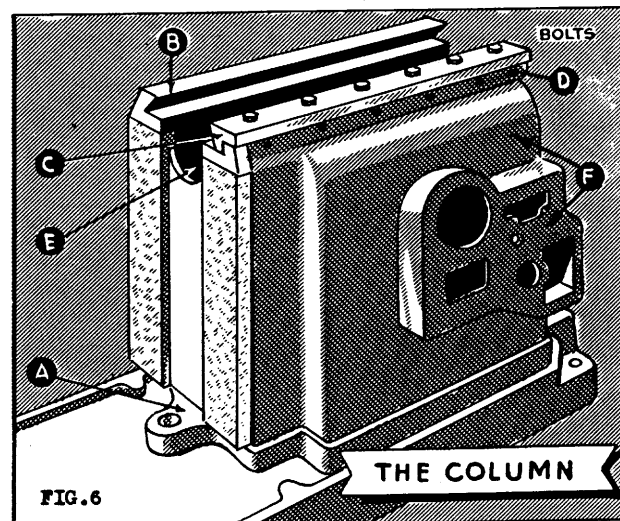
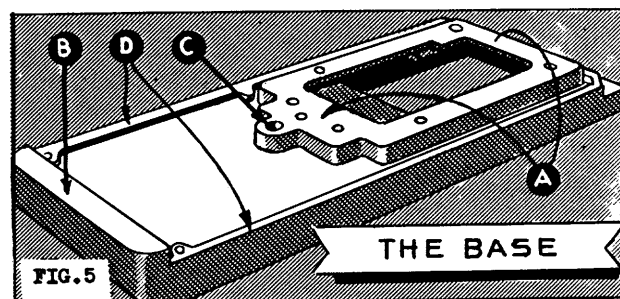

square box fit at the top of the rail, and, since an accurate fit must be maintained between these members, taper gibs using end screws for adjustment are supplied in both of these places.

Interaction of a stationary nut attached to the rear face of the saddle and a cross-feed screw mounted in the rail permit horizontal movement of the saddle on the guide ways of the cross rail. A graduated collar C on the cross-feed screw permits micrometer adjustment of the saddle and table in a horizontal direction. Felt wipers B assist in maintaining these parts in good working condition by cleaning and lubricating their bearing surfaces.

T-slots, which extend either partially or entirely across the front face of the saddle, accommodate bolts used to clamp the table to this member, thus making a single unit of these parts. Usually, when the T-slots extend only partially across the saddle, another slot is placed in its face for the alignment of fixtures which may be substituted for the table.

DESCRIPTION OF THE TABLE

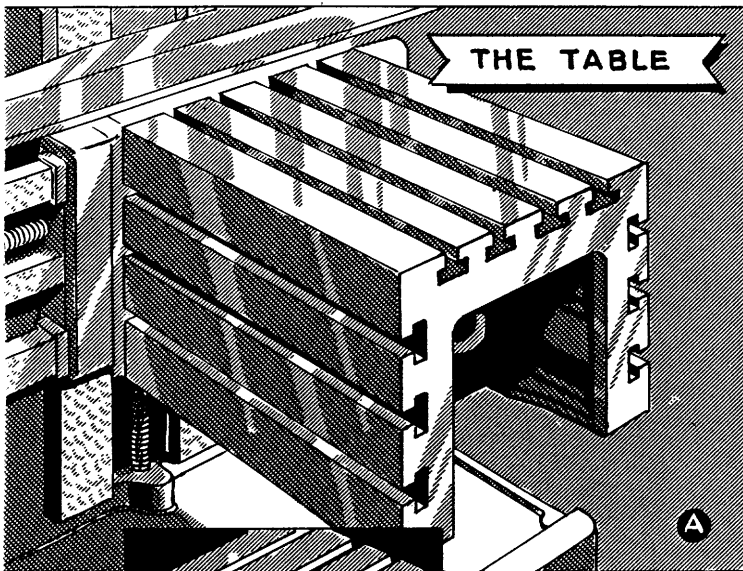

FIG. 9

The table is a rectangularly shaped casting of boxlike construction with openings at the front and at the bottom. All of its surfaces have been machined accurately. The need for such accuracy must be apparent since each face serves in one of two capacities — either for locating the table in relation to other parts of the shaper or for locating and holding the work or work-holding device during the machining process.

The rear face of the table is clamped to the front face of the saddle by means of bolts which are supplemented by dowels or a key to maintain, permanently, the relationship between these parts.

The front face is used as a clamping surface for a table support as shown in A, Fig. 10. With a support of the type shown in B, Fig. 10, both the front and the bottom surfaces function with the slide.

The remaining surfaces, that is, the top and the two sides, are

used for locating and holding work directly, or for locating and holding a vise or fixture which, in turn, grips the work.

The surfaces used for holding the work have T-slots which accommodate bolts used for work-clamping purposes. The spacing and the direction of these slots, however, are not similar in all makes or models of shapers, and each manufacturer advances good reasons to justify the particular arrangement used in his product.

Two common designs prevail in regard to the direction of the T-slots. In one A, the slots on all surfaces used for clamping work run horizontally; in another B, the slots on the top and on the left side run horizontally, but those on the right side run vertically. Also, tables with vertical T-slots generally have a vertical V-shaped groove for quickly aligning and clamping shafting to the table in an upright position.

Another variation in table design C includes holes provided in its clamping surfaces for use with table stops, and the extension of the upper working surface at both the front and rear. This design provides places for clamping the table to the saddle at the top in addition to the usual bolts in its front face.

DESCRIPTION OF THE TABLE SUPPORT

The table support extends from the worktable to the base of the machine. Its purpose is to support the outer end of the table and thereby prevent deflection which might occur during the cutting process, or deflection which might be induced by the unsupported weight of the table itself.

Despite wide variations in detail, designs of table supports readily lend themselves to placement into one or the other of two general groups. Into one group A, may be placed all supports which are bolted to the table and slide over a planed bearing surface of the base extension when the table moves horizontally. Into the other group B, may be placed those which are bolted to the base of the shaper, a group in which the sliding action takes place at the bottom of the table instead of on the base of the machine.

Elongated slots permit adjustment of the table support vertically to suit the table and cross-rail positions, and clamping bolts securely lock the support in place.

Bearing surfaces on which the table supports slide are sometimes protected from chips, and simultaneously lubricated by the felt wipers attached to the ends of the support. (Refer to Fig. 39, page 31.)

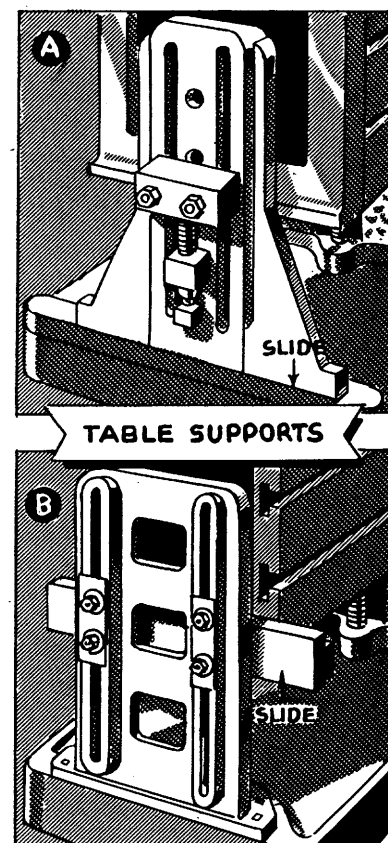
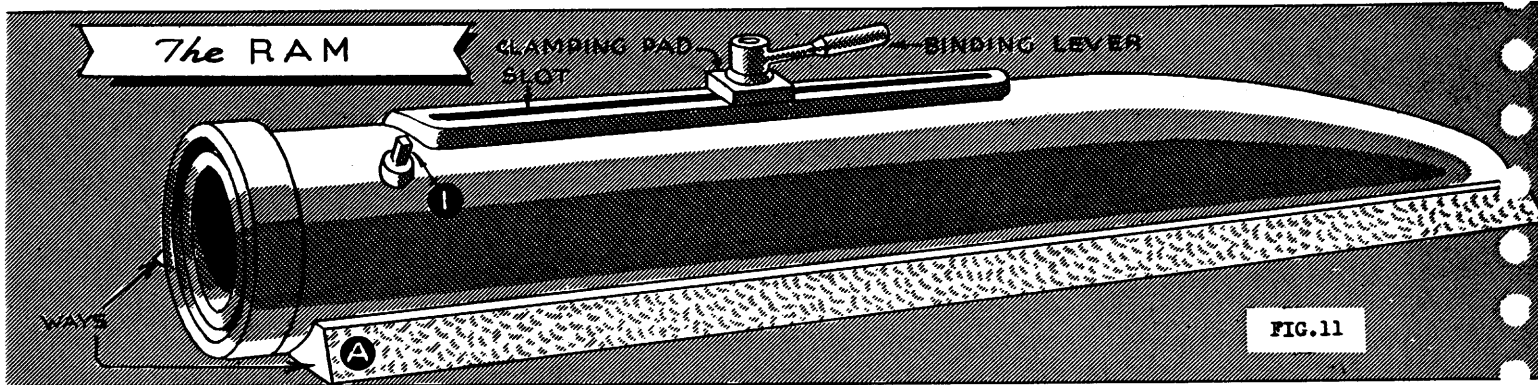

FIG.10



DESCRIPTION OF THE RAM

The ram is the long and rather narrow member of the shaper, designed to move back and forth horizontally in the uppermost section of the column. It is the part which supports the cutting tool and also guides it over the work during the cutting process.

The V-shaped ways A extend along the entire length of the ram, and, together with the Ram ways in the column, form its guiding surfaces.

A gib, either tapered or straight (Fig. 12), is provided to take up wear which may occur between these moving parts. No difficulty should be encountered in determining which type gib has been used, since the means of adjusting one differs noticeably from that used for adjusting the other. The taper gib, for example, utilizes a single screw shouldered against the large end for adjustment, whereas the straight gib requires a series of screws spaced along its entire length in the column to accomplish the same result (Fig. 12).

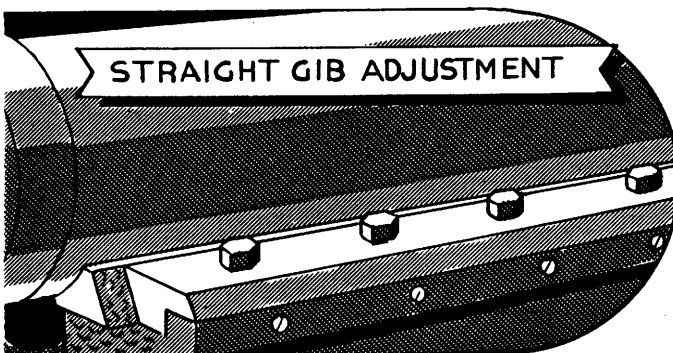
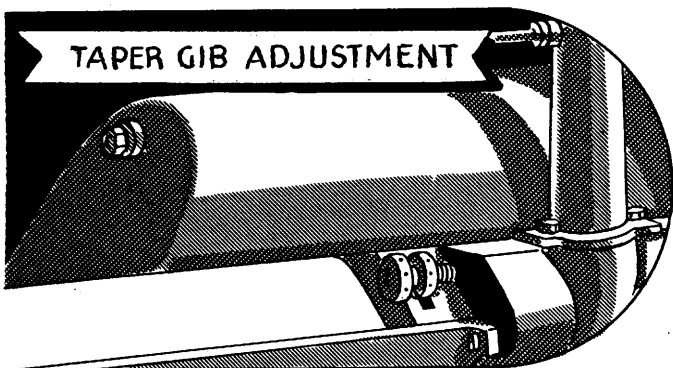
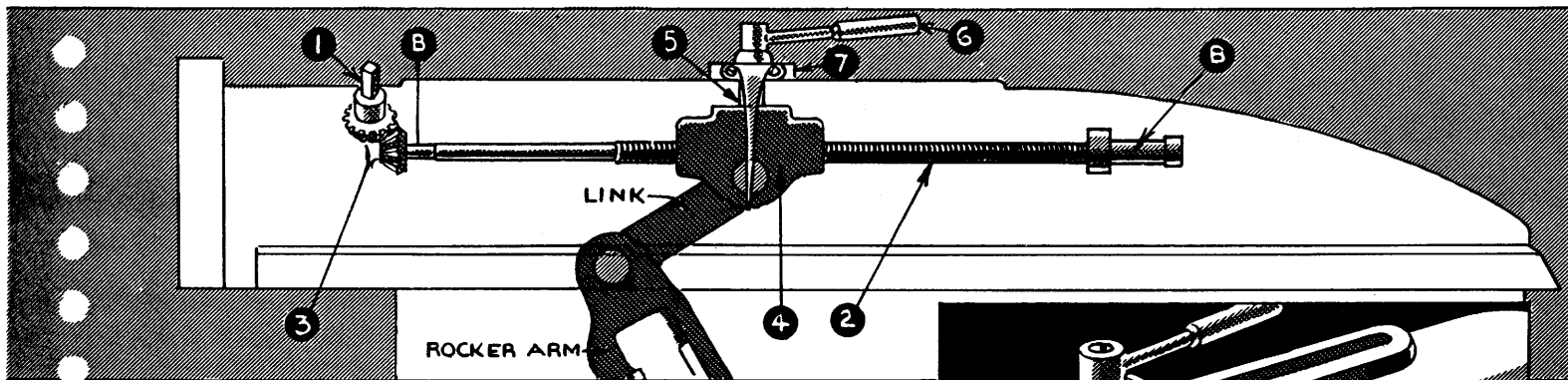

FIG. 12

To the list of parts and surfaces already alluded to must be added the parts which aid in placing the ram stroke over the surface to be planed (Fig. 13). These parts include shaft 1 whose outer end has been squared to receive a crank for use when the ram is being placed, horizontal screw 2 which extends almost the entire length inside the ram and is supported in bearings at B, and bevel gears 3 which connect the shaft and the screw 2.

Also to be included is the stationary nut 4 which aids in placing the ram, and assists in clamping it in position as well. The nut is linked to the rocker arm below, fits the thread on screw 2,



and extends up to the inner surface of the ram. Stud 5, which is free to slide in the elongated slot in the ram, extends up from the nut, within, to the binding lever 6 on top of the ram, and, together with clamping pad 7, these parts furnish the means whereby the ram is clamped in position.

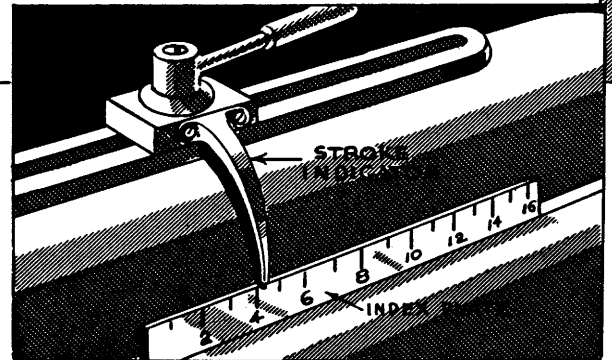

FIG. 13

Many shapers of older design use a stroke indicator which attaches to the clamping pad on the ram and extends down to a stationary index plate on the column. This index plate resembles a scale in that it is marked off in inches, the largest number appearing on the index plate coinciding with the maximum length of stroke attainable on the machine, such as number 16 for a 16-inch shaper, etc.

Since the ram and the stroke indicator move as a unit, providing the binding lever has been tightened, the length of ram stroke in inches will be the same as the number on the scale to which the indicator points when the ram has reached the rear end of its stroke.

A description of the stroke indicator and its scale has been included here only because of their proximity to the ram. Their connection with the stroke-adjusting mechanism has been described on page 20.

In addition, some shapers have an automatic vertical feed F for the tool head (Fig. 14). On shapers so equipped, the feed mechanism is attached to the right side of the ram directly behind the head. Motion is transmitted to the feed screw in the head by feed lever L which is actuated as the ram moves back and forth by an adjustable tappet T on the column.

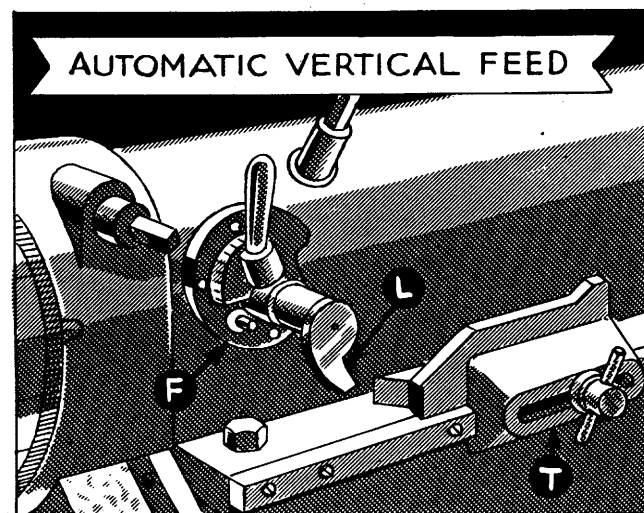

FIG. 14

DESCRIPTION OF THE TOOL HEAD

The tool head is clamped to the forward end of the ram. It comprises the parts which serve to hold the cutting tool and also those parts which guide the tool vertically and adjust it for the desired cut. Although their construction may vary somewhat in detail, all tool heads for the shaper are quite similar in appearance and in function, since each is an assembly of parts somewhat similar in design to those described herewith. (Refer to Fig. 15.)

A swivel block **B** connects the tool head to the ram, using for this purpose two binder bolts which extend from the annular T-slot in the face of the ram and pass through holes in the swivel block.

Another function has been assigned to the swivel block, that of allowing the tool head to be adjusted for making vertical and angular cuts with the aid of the tool slide **C**.

A circular projection on the rear of the swivel block extends into a recess in the ram, and not only centers these parts with each other, but also allows the tool head to be set vertically or swung at an angle when the binder bolts have been loosened. The perimeter of the swivel block has been graduated in degrees for convenience in making angular settings on the tool head.

The front face of the swivel block includes a dovetailed opening which receives a dovetailed projection on the tool slide, and also a taper gib for keeping these parts properly adjusted. With the aid of the stationary nut and the ball crank on the end of the down-feed screw **A**, the tool slide may be moved a considerable distance in the swivel block. The direction of the cut, whether angular or vertical, will be determined by the setting of the swivel block.

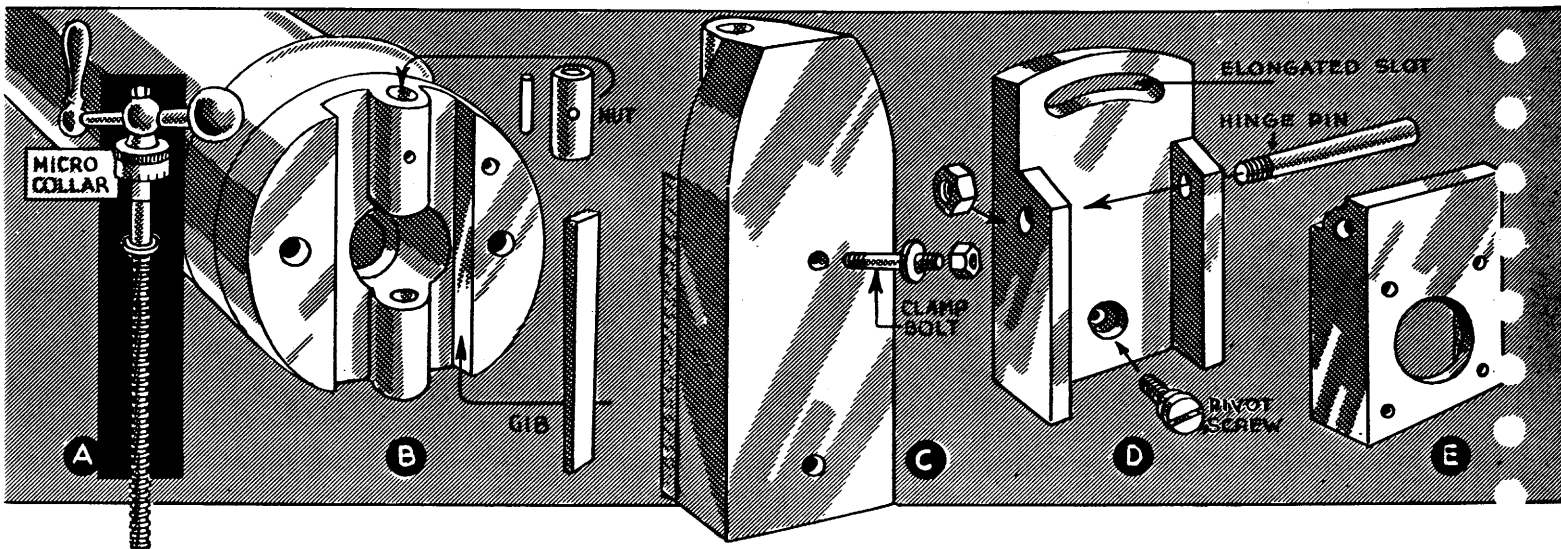

An adjustable micrometer collar, graduated in thousandths of an inch, indicates the distance through which the tool slide moves when movement of the handle turns the down-feed screw in the stationary nut..

Most shapers come equipped with a tool-slide lock for holding the tool slide in a fixed position for horizontal shaping.

Also included among the parts comprising the tool head is a group called the apron. It consists of a clapper box D, a clapper block E, a serrated plate F, a tool post G, a hinge pin, and a pivot screw.

The cutting tool is held in the tool post securely between the tool-post screw and the tool block. The serrations on the plate attached to the tool block prevent the tool from slipping during the cutting process. A block is placed ahead of the tool-post screw to prevent indentations which are likely to occur on the tool holder when pressure from the tool-post screw is applied in the same place repeatedly.

Since the shaper tool cuts on the forward stroke only, the apron has been so constructed that it supports the tool rigidly during this stroke and allows it to lift slightly and also to swing clear of the work entirely, if necessary, during the return stroke. This construction prevents severe rubbing and subsequent damage to the cutting edge of the tool.

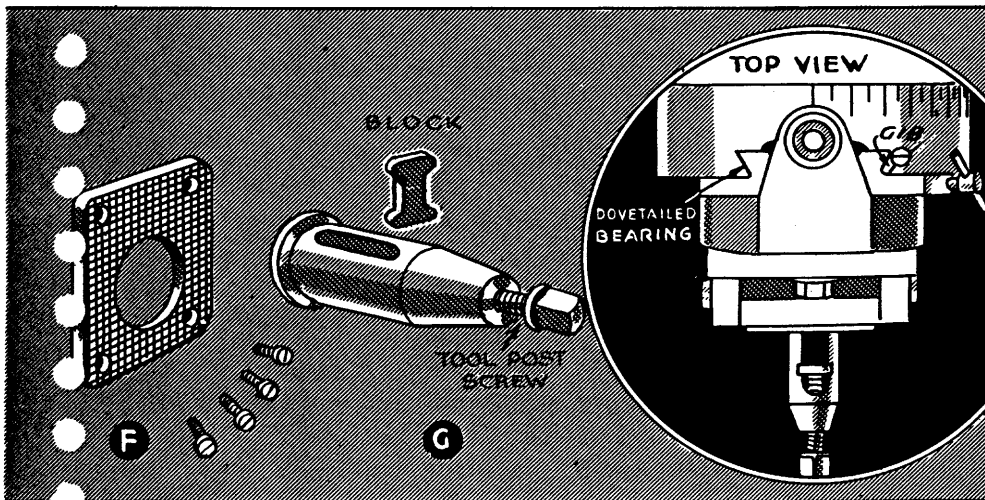
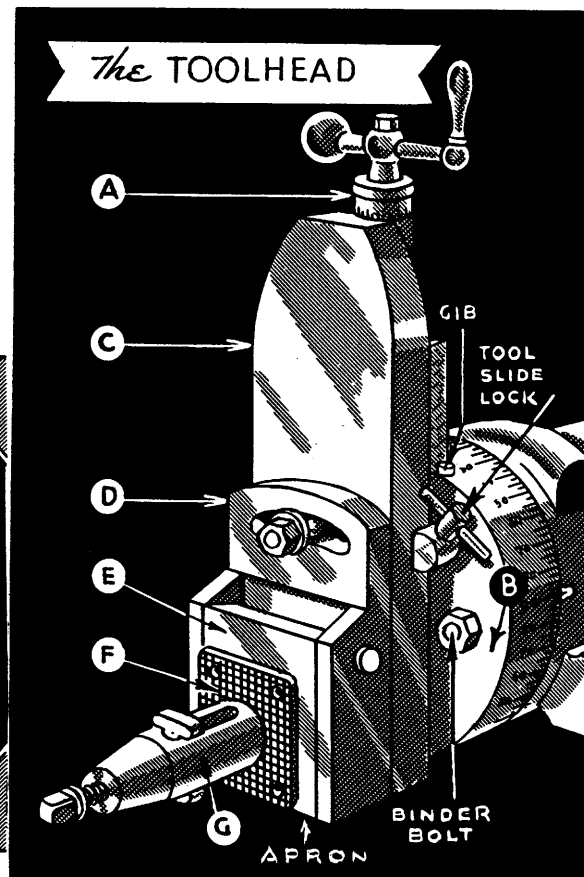

FIG. 15



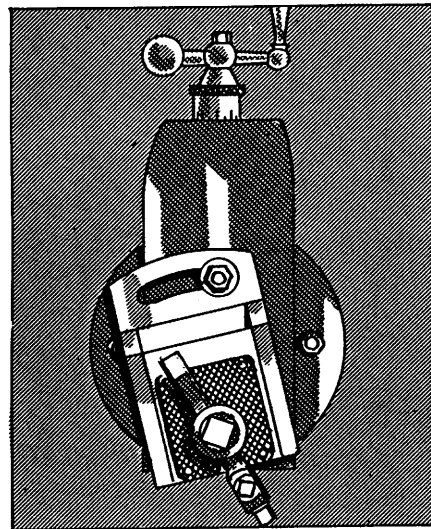
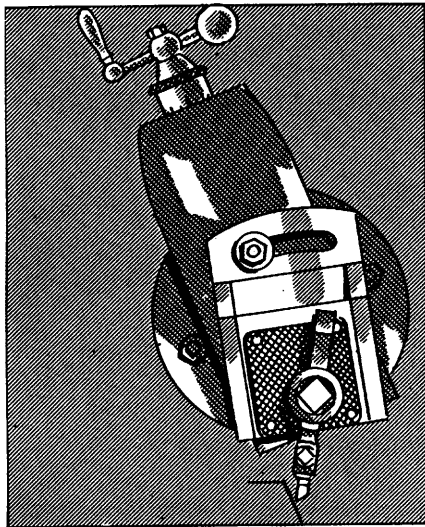

FIG. 16

The clapper block E, or tool block, as it is also called, fits snugly against the sides and the back of the clapper box D. It is held in place by the hinge pin which, by means of its taper, has been so finely adjusted that the tool block will not move perceptibly during the cutting stroke, although it will lift readily on the return stroke for reasons which have been previously stated. This explanation describes the action of the tool block during a horizontal cut.

For a vertical or an angular cut, however, lifting of the tool is not sufficient; it must also swing clear of the work on the return stroke to avoid interference.

The clapper box has been designed to meet this additional requirement, that of swinging the tool out from the work on the return stroke when it is cutting in a vertical or an angular plane. It accomplishes its assignment in the following manner.

The clapper box is attached to the tool slide by means of a pivot screw and a clamping bolt. When the clamping bolt has been loosened, the clapper box may be swung through a small arc in either direction within the limits of its elongated slot without altering the position of the pivot screw.

Thus, if the clapper box is swung to the right, the cutting tool will lift and also swing away from a right-hand vertical surface and vice versa for a left-hand setting of the clapper box. For horizontal cuts, the clapper box is usually set vertically.

The use of the apron has been further explained on pages 186 and 187.

To this point, no distinction has been made between the crank-driven shaper and the hydraulically driven shaper. Since the parts described thus far have been common to both types of machines, this was not required.

From this place forward, however, the parts for these two types of machines differ and therefore will be described under separate headings — the description of the crank shaper continuing from here on, and that of the hydraulic shaper beginning on page 33.

DESCRIPTION OF THE DRIVING MECHANISMS FOR A CRANK SHAPER

The member which actuates the ram, that is, the part which controls the back-and-forth movement of the ram, is called the rocker arm. This casting is hinged at its lower end by means of a rocker-arm shaft A (Fig. 17) located near the base of the column. The upper end of the rocker arm connects with the ram by means of a link B and a clamp block C, the link compensating for changes which occur in the vertical length of the rocker arm as its upper end swings through an arc centered at the rocker-arm shaft. An explanation of the function of the clamp block has been included with the description of the ram on page 13.

Since the movement of the ram on the one hand is backward and forward and since that of the drive pulley on the other hand is circular, it must be apparent that a change of movement, from circular to reciprocating, has been effected within the machine.

This change in movement could be accomplished by several means, but since the shaper described here has been named a crank shaper, and if we apply what we have previously learned — that one way of classifying the shaper is on the basis of the driving mechanism employed — then we must conclude that a crank pin has been used for actuating the rocker arm.

Fig. 18 illustrates how the crank-type drive mechanism, functioning through the rocker arm and its connecting parts, causes the ram to reciprocate.

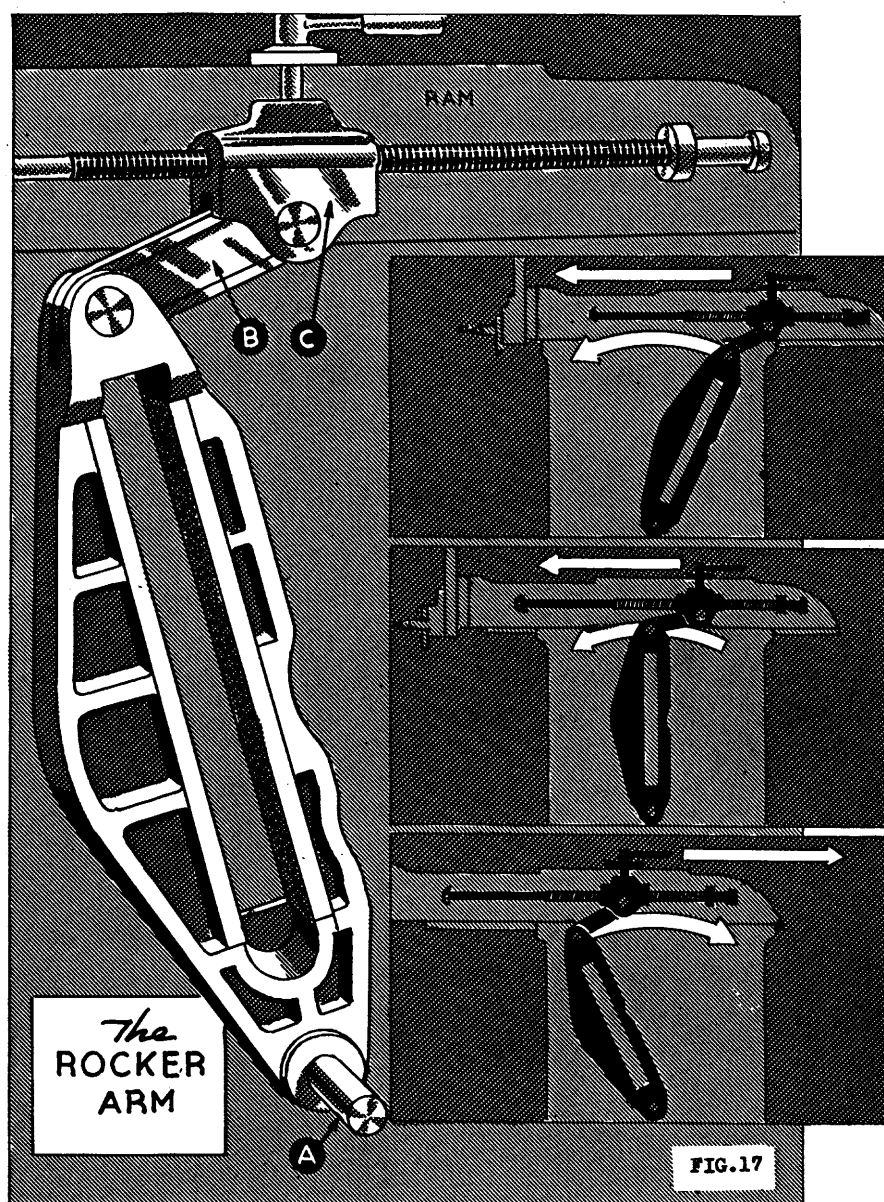

Mounted within the column and directly behind the rocker arm is the main drive gear A, also called the bull wheel. This gear revolves on its hub which extends into a bearing mounted in the column wall. It is driven by pinion B and is connected through gearing with shaft C on which the drive pulley has been mounted. Whether the bull wheel revolves fast or slow is determined by the speed for which the machine has been set. The mechanism for changing speeds has been explained on page 21.

Slide block D has been mounted on crank pin E, and together they extend from the face of the bull wheel into a slot in the rocker arm. The sliding block has been added for the reason that it provides longer and more enduring bearing surfaces in the slot than would the crank pin if the latter were used without the block. As the

bull wheel revolves, the crank pin rotates in a circular path about the center of the large gear. During this rotation, the slide block turns on the crank pin and at the same time slides up and down in the slot in the rocker arm, thus causing the rocker arm to move forward during one part of a turn of the bull wheel and backward during the remainder of its revolution.

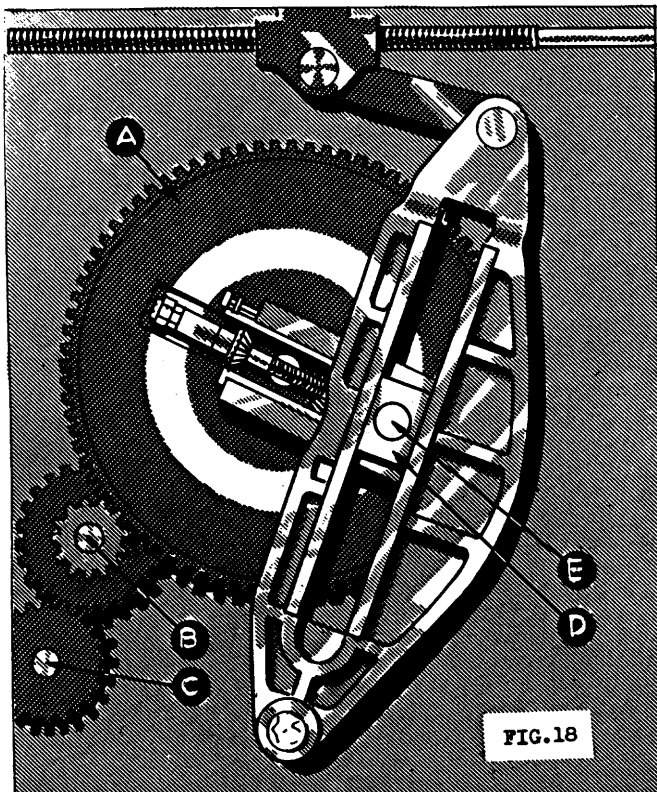

Fig. 19 indicates in successive order several of the relative positions occupied by the crank pin, the slide block and the rocker arm during a revolution of the bull wheel. 1 and 3 show the rocker arm in its extreme backward and forward positions, respectively; 2 shows it in the center of a forward stroke when the slide block is in its upper position; and 4 shows the rocker arm in the center of a return stroke when the slide block is in the lower end of the rocker-arm slot.

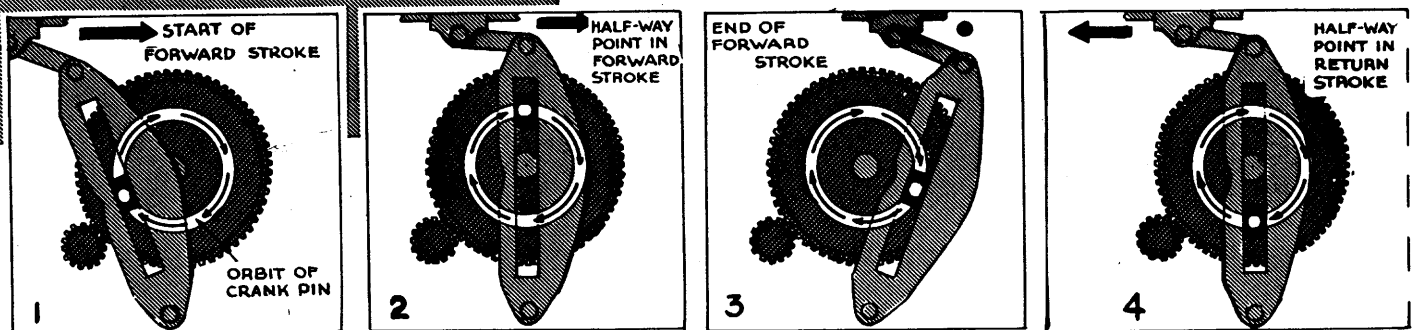

FIG. 19

DESCRIPTION OF THE QUICK RETURN

The driving mechanism of a shaper has been so designed that the return stroke of the tool is faster than the cutting stroke, the purpose being to reduce the idle time of the tool, inasmuch as it does not cut on its return stroke.

Fig. 20 illustrates how this is accomplished. The crank pin (and the slide block) occupies the position marked R when the rocker arm is in its rear position. In operation, the crank pin moves in the path and in the direction indicated by arrows passing through arc A which terminates at point F. This portion of a revolution represents the cutting stroke, and point F marks the beginning of the return stroke. The slide block has moved in the upper end of the rocker-arm slot during this stroke.

When the crank pin reaches point F, the rocker arm stops momentarily, since it is at this point that the rotation of the crank pin reverses the direction of the rocker arm and the ram begins its return stroke. This return movement occurs while the crank pin moves in the lower portion of its circular path close to the pivot of the rocker arm, indicated as arc B, and continues until the crank pin again reaches the starting point R. This marks the completion of one cycle. (Refer to Fig. 19 also.)

Since the bull wheel rotates at a uniform speed, the illustration must make it apparent that the cutting stroke requires more time than the return stroke, the ratio of the time required for the cutting stroke to that of the return stroke being the same as the ratio between the lengths of arcs A and B. This ratio is approximately 1-1/2 to 1. In other words, it takes 1-1/2 times as long to make the cutting stroke as it does to make the return stroke. Refer to Description of Speeds and Feeds, page 293.

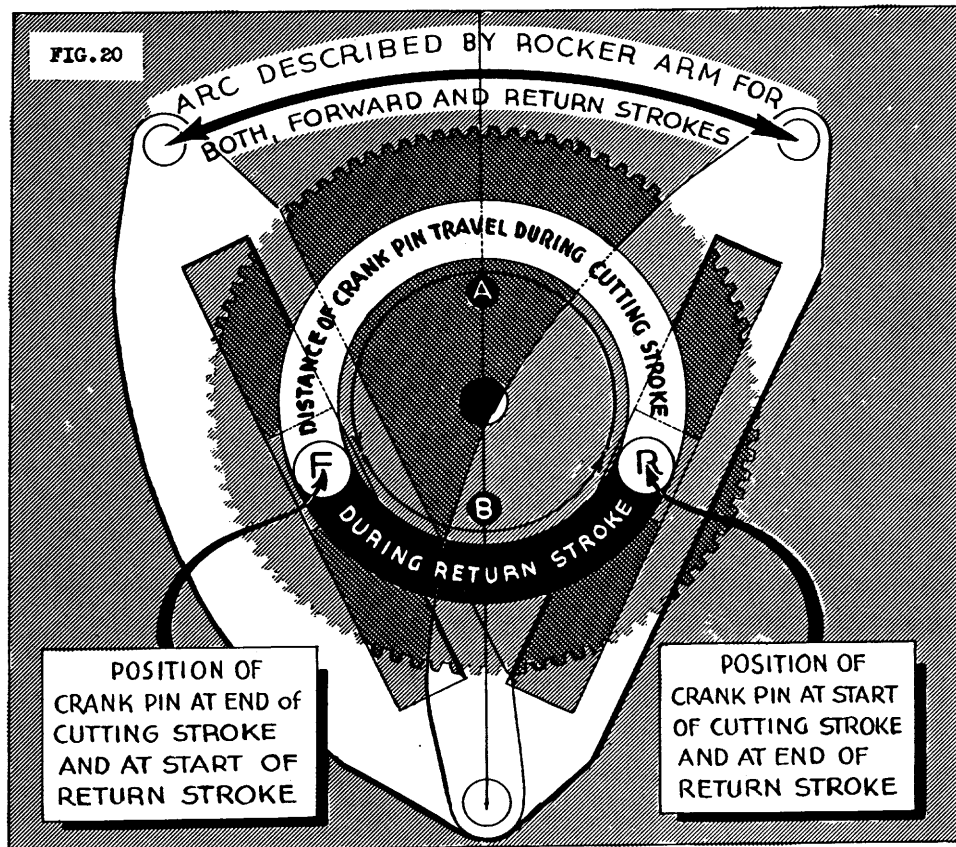

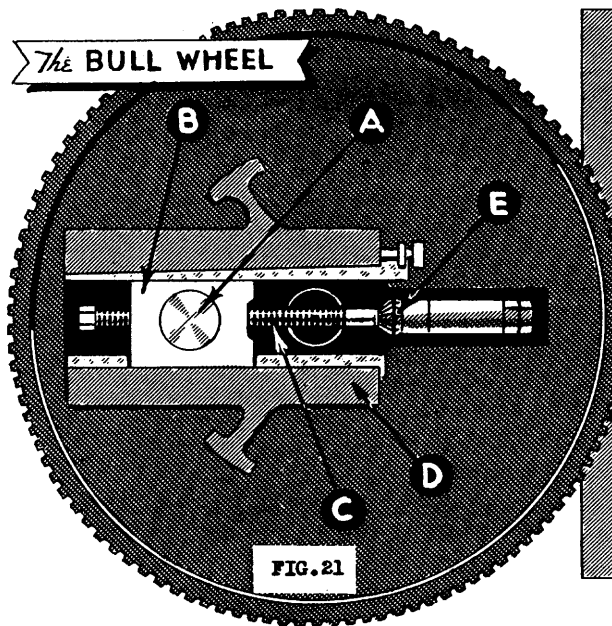

FIG. 21

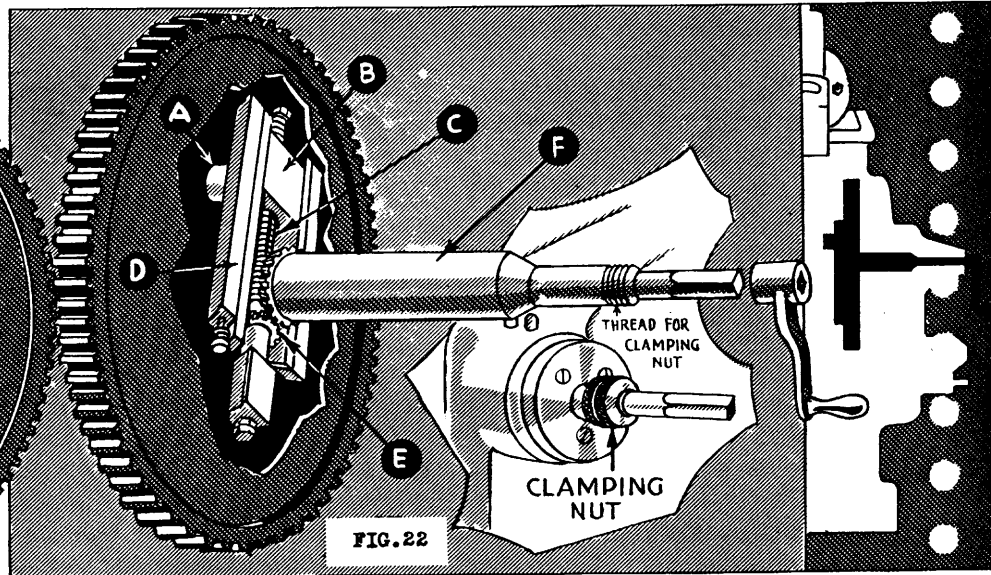

FIG. 22

DESCRIPTION OF STROKE-ADJUSTING MECHANISM

Since the jobs performed in the shaper vary considerably in length, it would be impractical to use a machine with a single, fixed length of ram stroke. The ram stroke, therefore, has been made adjustable to facilitate shaping both long and short work. This is accomplished by moving the crank pin A (Figs. 21 and 22) toward or away from the center of the bull wheel, since the crank pin governs the movement of the rocker arm and consequently the length of the ram stroke.

For this reason the crank pin has been mounted in a movable crank block B, threaded to receive the adjusting screw C, as shown in Fig. 21. The crank block together with the crank pin may be adjusted in the slide D on the face of the bull wheel by turning the adjusting screw C. In this way the position of the crank pin, and its relation to the center of the bull wheel, may be varied from "on center," when no ram movement occurs as the bull wheel turns, to one at the end of the slide D, a position of the crank pin which causes the ram to travel through its maximum stroke.

Since it is desirable to adjust the ram stroke from a point outside the shaper, a stroke-adjusting shaft F (Fig. 22) has been extended through the center of the bull wheel to a point where its inner end connects with the adjusting screw C through bevel gears shown at E. The outer end of this shaft, which protrudes

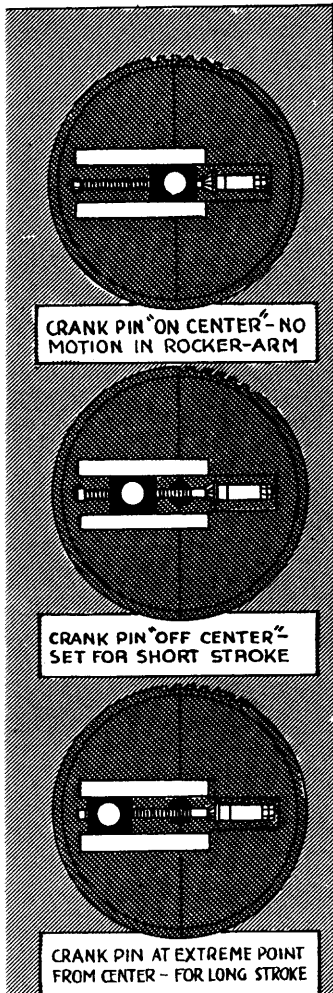

from the column, has been squared to fit a crank used for adjusting the ram stroke.

The outer end of the stroke-adjusting shaft is also provided with a means for locking it in place so that it will not turn and change the length of the stroke once it has been set. Various devices are used for this purpose, the threaded clamping nut perhaps being the most common (Fig. 22).

This nut has been displaced on many of the newer shapers, however, by a clamping device which automatically fulfills the purpose of the old-type clamping nut. The newer clamping units have been so designed that freeing of the clamping device occurs coincidentally with placing of the crank on the squared end of the stroke-adjusting shaft, and clamping takes place automatically when the crank is withdrawn from the shaft.

For additional convenience in setting the length of the ram stroke, the shaper has been equipped with an index plate and a pointer or a dial and a pointer. The pointer moves along its adjacent scale when the stroke-adjusting shaft is turned (Fig. 23). The highest number to which the pointer advances indicates in inches the length of the stroke for which the machine has been set. A type of index plate and pointer used with older designs of shapers has been described on page 13 in connection with the description of the ram.

A description of the parts necessary for placing the stroke so that the travel of the tool covers the surface to be shaped, has been included with that of the ram on page 12.

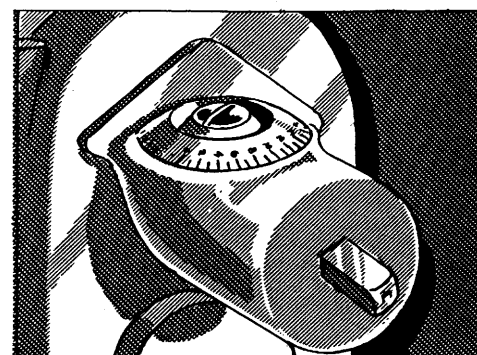
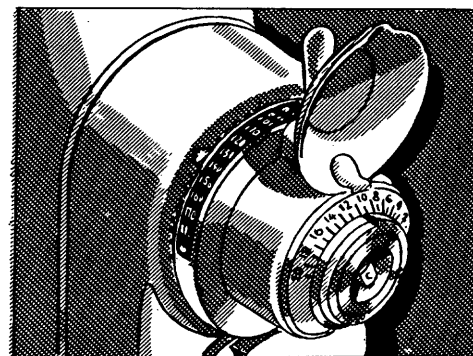
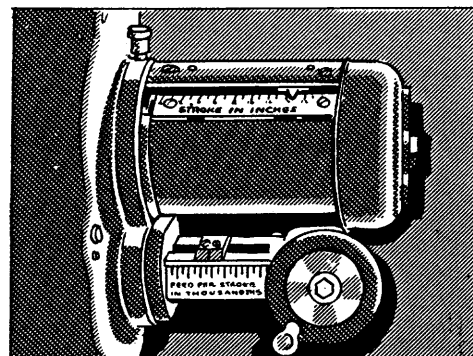
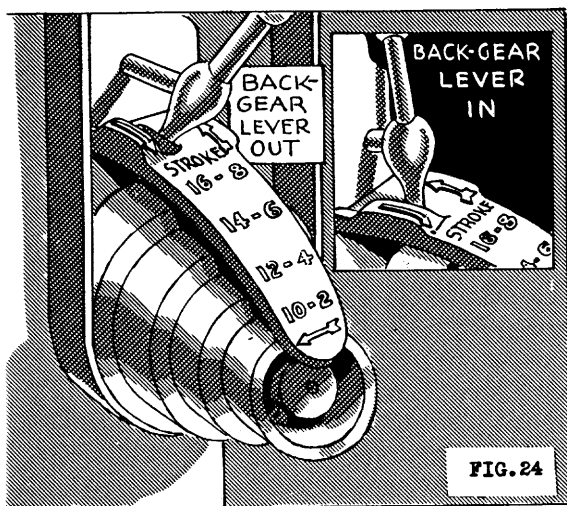

FIG. 23

DESCRIPTION OF THE MECHANISM FOR CHANGING SPEEDS

The speed of the shaper is usually associated with the number of cutting strokes the ram makes in a minute, and is determined by the speed, or the number of revolutions per minute, of the driving gear or bull wheel. Variations in the length of stroke, differences in the consistency of the material being cut, and difficulties encountered in the performance of certain operations, require that the speed of the shaper be adjustable. There are several different ways in which the speed of the machine may be changed, the method used depending on the type of drive mechanism employed on the machine. The simplest among these is the cone-pulley drive. The speeds are varied by shifting the belt from one step on the pulley to another



of a different size, the number of speed changes possible being limited to the number of steps on the pulley. (Refer to Fig. 24).

All but the smallest cone-driven shapers, however, have been provided with back gears inside the column, making an additional series of speeds available and thereby doubling the range of speeds. The back gears may be engaged and disengaged by means of a lever outside the column.

The double row of numbers on the plate above the cone pulley, when used in conjunction with the length of ram stroke, will assure an approximately correct cutting speed. Ar-

rows on the upper end of this plate indicate the position the back-gear lever should occupy (toward or away from the column); the location of the number which corresponds with the length of the ram stroke in inches, indicates the step on the cone which the belt should occupy.

Instead of having a cone pulley, some shapers come equipped with a single constant-speed pulley and a sliding-gear transmission whereby the necessary speed changes may be obtained. In this design the gears may be placed entirely within the column or in an overhanging gear box attached to the column of the machine. The gears are placed between the drive pulley and the gearing which connects with the main drive gear.

The power may be supplied to the drive pulley on the transmission from an overhead countershaft. In another design, an individual motor, mounted at the rear of the machine and connected with the transmission either by belting or by a series of gears, may be used for this purpose.

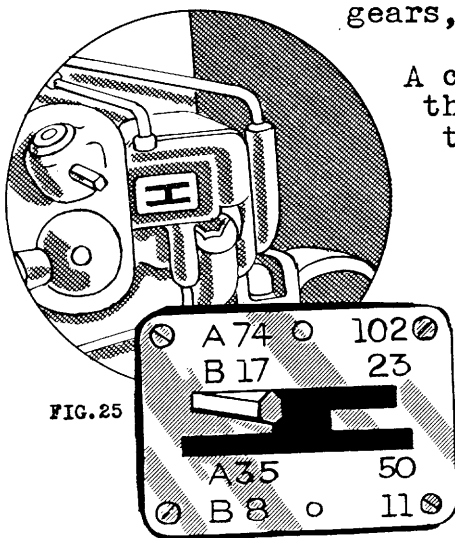

A clutch is generally used in connection with these drives to facilitate starting and stopping the shaper without recourse to the button used for starting and stopping the motor. Most shapers are provided with a brake for quickly stopping the ram after the clutch has been disengaged.

The different speeds are obtained by arranging the gears in the transmission in varied combinations by means of levers connected with the gears and extending to the operator's position on the right side of the column. Eight speeds are usually pro-

vided. They are available in two series of four each. An index plate (Fig. 25) attached to the gear box indicates the number of strokes per minute for each position of the handles used for shifting the gears.

DESCRIPTION OF THE FEED MECHANISM ON A CONE-DRIVEN SHAPER

Although the feed mechanism on nearly every make of shaper differs somewhat from that on every other make, there are certain general principles underlying the construction and operation of all of them. An understanding of the general principles involved, plus a knowledge of the details wherein several of the mechanisms differ, should provide a basis for analyzing variations in construction even though they have not been explained here.

On most shapers the automatic feed may be applied only for moving the table on the rail, but on some shapers both the cross-feed screw and the elevating screw are connected with the automatic feed mechanism. This design provides vertical as well as cross feeding of the table by means of power. The cross-feed mechanism operates once for each cutting stroke of the ram.

All but the more recent models of shapers were so designed that they could be made to feed at either one end of the ram stroke or the other. Newer machines, however, have been so arranged that the feed is confined to the return stroke; but on all of them the feed may be disengaged or thrown out of gear and the feeding done by hand where required (Fig. 26).

Fig. 7 illustrates the position of the table feed screw in the cross rail and shows the nut used to move the table. Since the screw cannot move endwise, it must be apparent that the nut into which the feed screw is threaded and which is attached to the worktable, or to the saddle, feeds the table along the cross rail when the screw is turned. The end of the feed screw has been squared in order that the table may be fed by hand with a crank. Furthermore, a micrometer collar has been attached to the feed screw adjacent to the square so that the table movement may be measured in thousandths of an inch.

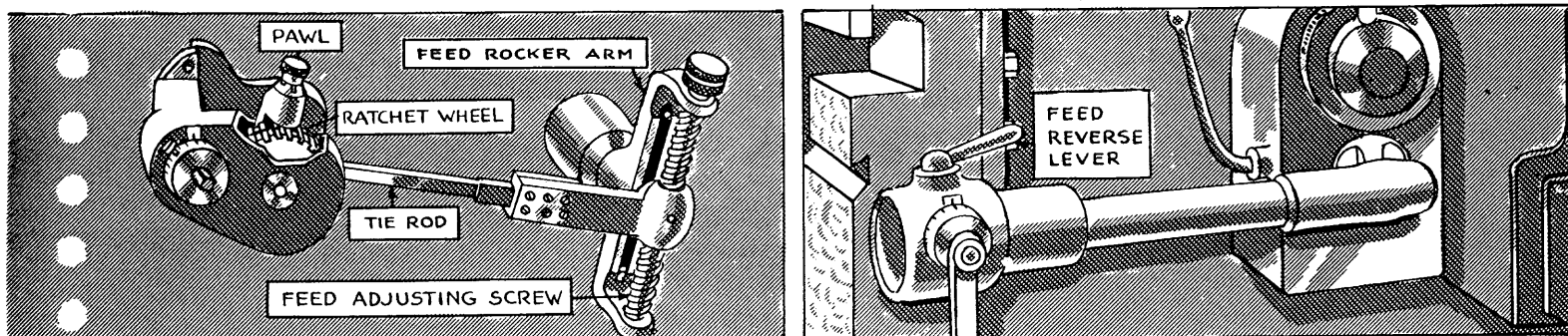
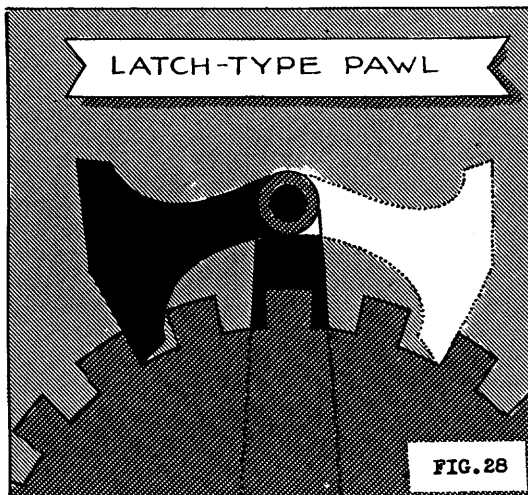
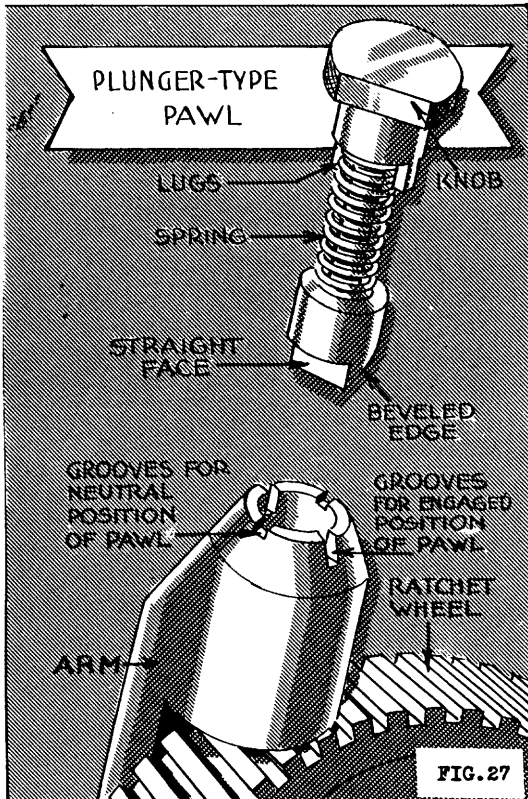

FIG. 26



On all shapers the amount of feed, that is, the distance the table moves toward the tool for each stroke of the ram, is determined by the part of a revolution which the screw is caused to make by the feed mechanism, but among the means used to turn the feed screw automatically there is considerable variation.

Generally, the portion of the feed mechanism which directly causes the feed screw to make a partial turn after each stroke of the ram, includes a ratchet wheel, a pawl, and an arm which carries the pawl, a form of construction which induces intermittent motion in one direction and avoids it in reverse (Fig. 29).

The ratchet wheel is keyed to the feed screw, or it may transmit its motion to the feed screw through gears. The arm which carries the pawl fits freely on the feed screw, and, as the arm oscillates (swings backward and forward) about the screw, the plunger-type pawl which moves up and down in the arm (Fig. 27), or the latch-type pawl which pivots on the arm (Fig. 28), falls into the space between the teeth on the ratchet wheel, and is held there by a small spring.

The pawl is made with one straight face and one beveled edge. When the arm swings to the left, the straight face of the pawl meets the face of the ratchet tooth squarely, remains in the slot, and partially rotates the ratchet wheel (and the screw). After completing its swing to the left, the arm swings to the right an equal distance. But during the backward swing (to the right), the pawl is forced out of the slots because of its beveled edge, and caused to pass over one or more teeth of the ratchet wheel. The ratchet wheel itself remains stationary until the arm swings to the left again.

The movement of the arm which carries the pawl has been synchronized (timed) with that of the ram; that is, the pawl, actuated by the arm, moves the ratchet wheel and the feed screw during one stroke of the ram (Fig. 29 A), preferably during the return stroke, and slides over one or more teeth in the ratchet wheel during the forward stroke of the ram (Fig. 29 B), getting ready in this way to feed the work to the tool on the next return stroke.

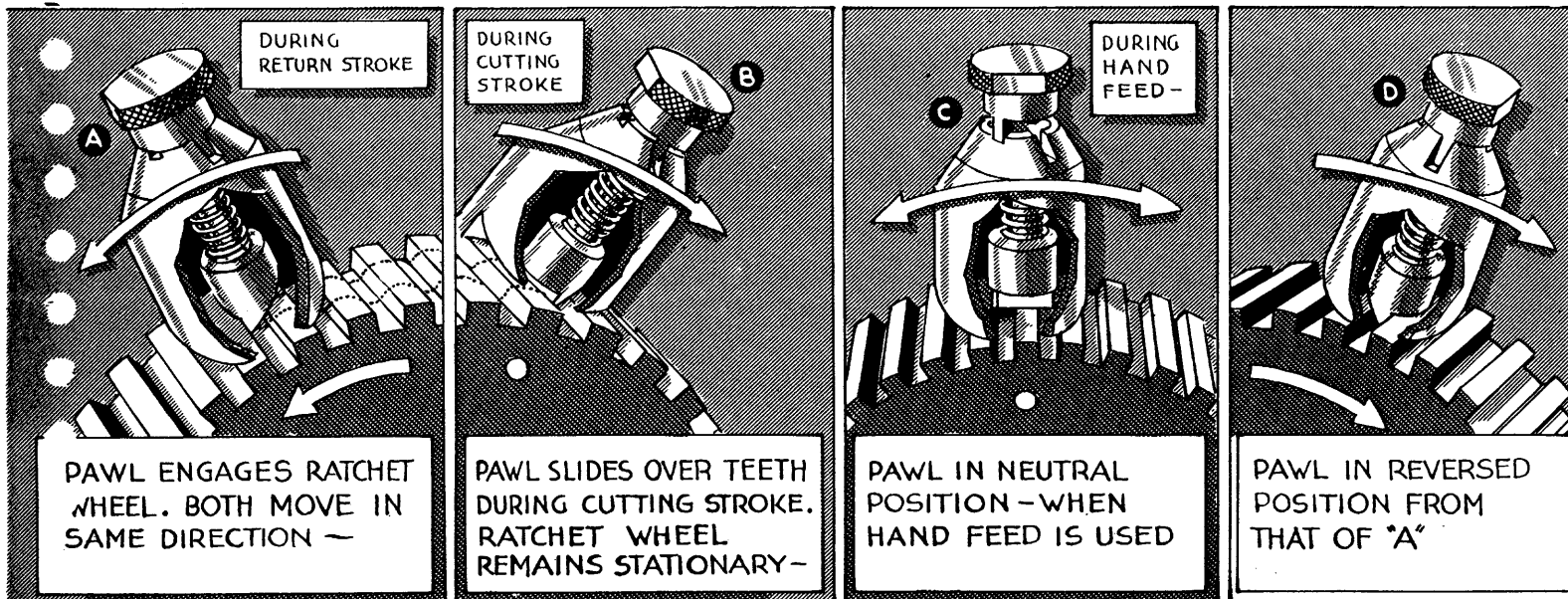

FIG. 29

Since it is desirable to feed the work in either direction, the feed mechanism has been so designed that the ratchet wheel may be rotated in either direction simply by reversing the position of the pawl (Fig. 29 D). This brings the driving face (the straight face) of the pawl against the opposite sides of the teeth on the ratchet wheel, thus changing the direction of its rotation as the arm oscillates.

The latch-type shown in Fig. 28 is double-ended. When it occupies the position indicated by the solid lines, the ratchet wheel will be rotated intermittently in a counterclockwise direction, and vice versa when the pawl has been placed in the position shown by the dotted lines.

Normally, the plunger-type pawl (Fig. 29) is held in the spaces on the ratchet wheel by a coil spring and when the pawl is in the position shown, movement of the pawl carrier causes the feed screw to turn in a counterclockwise direction.

When the pawl is lifted by means of the knob and turned one-half revolution, the ratchet wheel is caused to rotate intermittently in a clockwise direction, since the driving face of the pawl engages the opposite sides of the teeth. Obviously then, if the pawl is withdrawn from engagement with the ratchet wheel and subsequently withheld therefrom, the automatic feed will not operate, although the pawl arm continues to oscillate (Fig. 29 C).

To position the pawl properly, that is, to align its driving face with the teeth on the ratchet wheel when the feed is to be engaged and also to prevent the pawl from engaging the ratchet wheel when the automatic feed is not to be used, two slots have been cut into the pawl arm on the surface adjoining the knob. Furthermore, the knob has been made with projections, or lugs, on its underside to fit these slots (Fig. 27).

The deeper of the slots is cut parallel with the teeth on the ratchet wheel; the other at right angles thereto. When the knob has been turned to the position in which its projections may enter into the deep slot, the driving face of the pawl has been aligned with the teeth and the pawl is brought into engagement with the ratchet wheel by the spring. (Refer to Fig. 29).

When the knob is lifted and turned one-fourth revolution, its projections engage the shallower slot on the pawl carrier. In this position the pawl is held out of engagement with the ratchet wheel, and consequently the feed is inoperative. (Refer to Fig. 29 C).

Obviously, the amount of feeding movement imparted to the feed screw through action of the pawl on the ratchet wheel can be varied by increasing or decreasing the oscillating movement of the pawl arm.

Any appreciable change in the length of its swing effects a corresponding change in the number of teeth over which the pawl passes during the backward movement of the arm. The ratchet wheel remains stationary and the pawl assumes the position from which it will again give the feed screw a partial turn at the moment when the direction of the arm swing is reversed.

Two mechanical devices for regulating the amount of table feed are shown herewith; one is gear-driven (Fig. 30), and the other is actuated by an eccentric (Fig. 31); both are connected with the ratchet gearing on the feed screw by a tie rod.

The device in Fig. 30 employs a slotted disc fitted with a slide block which carries a crank pin for use with the tie rod. When knob K has been loosened, the slide block may be moved toward the center of the disc to decrease the feed—away from the center to increase the feed.

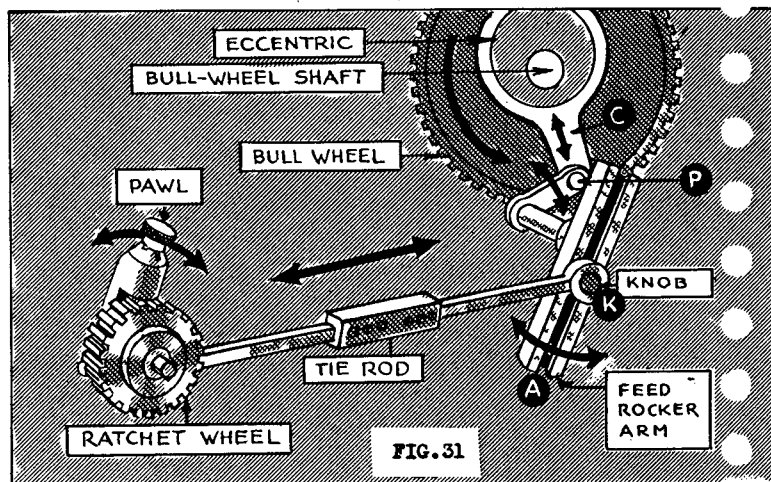
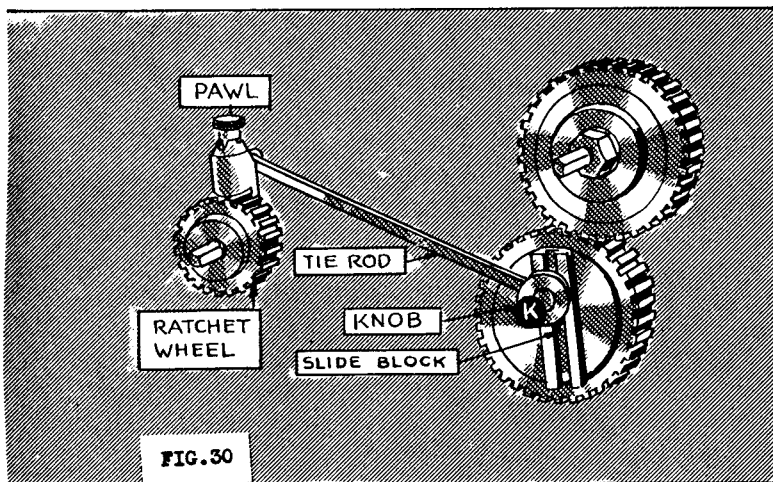

The disc is turned continuously in one direction only, two connecting gears being used for this purpose, one attached to the bull-wheel shaft and the other mounted directly behind the disc and on the same shaft. Since the gears are of equal size, the disc makes one revolution for each revolution of the bull wheel and causes an oscillating movement of the tie rod for each ram stroke.

In Fig. 31 only the mechanism used to impart oscillating movement to the feed rocker arm (and to the tie rod) differs from that employed for this purpose in Fig. 30; for, even though an oscillating rocker arm A, instead of a revolving disc, has been employed, the method used to vary the amount of feed remains quite similar. The amount of feed may still be increased or decreased by shifting the position of the crank pin in relation to the center of the feed rocker arm.

In Fig. 31 an eccentric revolving with the bull-wheel shaft causes the connecting rod C to move up and down once for each revolution of the main drive gear. Since the pin P extends into the lower end of the connecting rod, it too moves up and down and causes the rocker-arm shaft and the rocker arm attached to its outer end to oscillate a fixed distance. An eccentric is only one of several devices employed to cause oscillating movement of the feed rocker arm.

A screw, threaded into one end of the tie rod, has been added to the rocker arm in Fig. 32. This type of construction permits the amount of feed to be changed by simply turning the knob K to move the end of the tie rod toward or away from the center of the rocker arm.

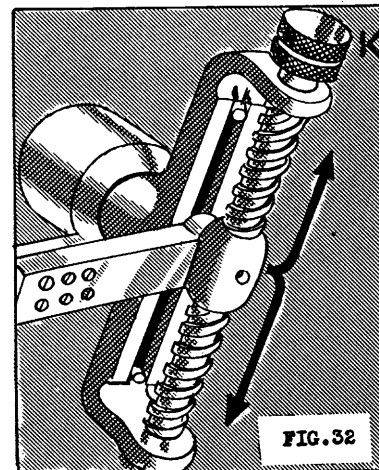

DESCRIPTION OF THE BEVEL-GEAR FEED REVERSE

The newer shapers have been so designed that the automatic feed always operates during the return stroke of the ram. Older machines are so arranged, however, that the feed can occur during either the forward or the return stroke. On this type shaper the feed functions during the forward stroke when the slide is moved in one direction from the center of the feed rocker arm, and during the return stroke when the slide is moved in the opposite direction.

On modern shapers, a cam on the bull-wheel shaft, instead of an eccentric or gears, imparts oscillating movement to the pawl arm. The ratchet gearing used on older machines for turning the feed screw, and also for reversing its direction of rotation, has been removed from its former location at the rail and combined with the rest of the feed mechanism at the side of the column. The action of the ratchet wheel and the pawl remains quite similar to that explained on page 25. The pawl, however, cannot be reversed, there

being no need for this, inasmuch as the intermittent movement from the feed mechanism is transmitted by means of a telescoping shaft to a bevel gear-reversing unit at the rail (Fig. 33).

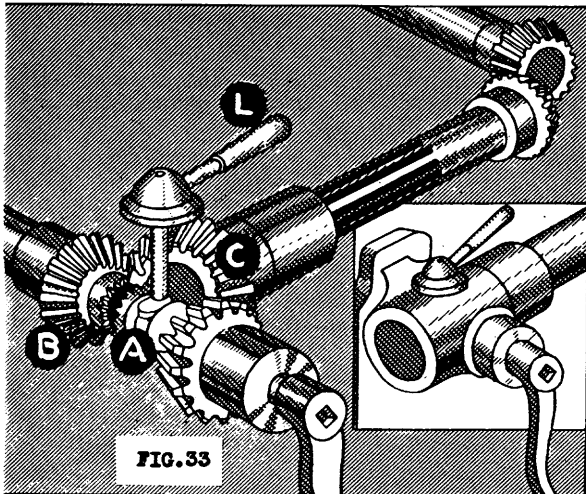

FIG. 33

A reversing unit, similar to the one illustrated, has been used frequently in machine construction where rotary motion in either direction is desirable. It comprises a positive clutch A which is keyed to the outer end of the feed screw between two bevel gears B. The larger bevel gear C on the end of the telescoping shaft, rotates these gears in opposite directions.

Although the bevel gears rotate intermittently as long as the machine remains in operation, the feed screw is caused to rotate only when the clutch has been shifted to the right or to the left and its interlocking teeth have been brought into engagement with those on the end of one or the other of the bevel gears.

Lever L provides control of the automatic table feed. Its position, whether center, right, or left, indicates not only the position of the clutch but also the direction in which the automatic feed will move the table. In other words, the shaper is said to have directional feed control, since the table moves in the direction in which the lever has been positioned.

Feed mechanisms of the type just described usually include a direct-reading feed dial, or a scale, and a feed selector (Fig. 34). For each position of the feed selector, the dial immediately indicates the amount of feed in thousandths of an inch for each stroke of the ram.

The number of different feeds obtainable on any

shaper, and their range as well, varies with the make of the machine. Usually, the amount of feed changes .010" when the feed selector is moved from one position to the next on the dial. Movement in one direction in-

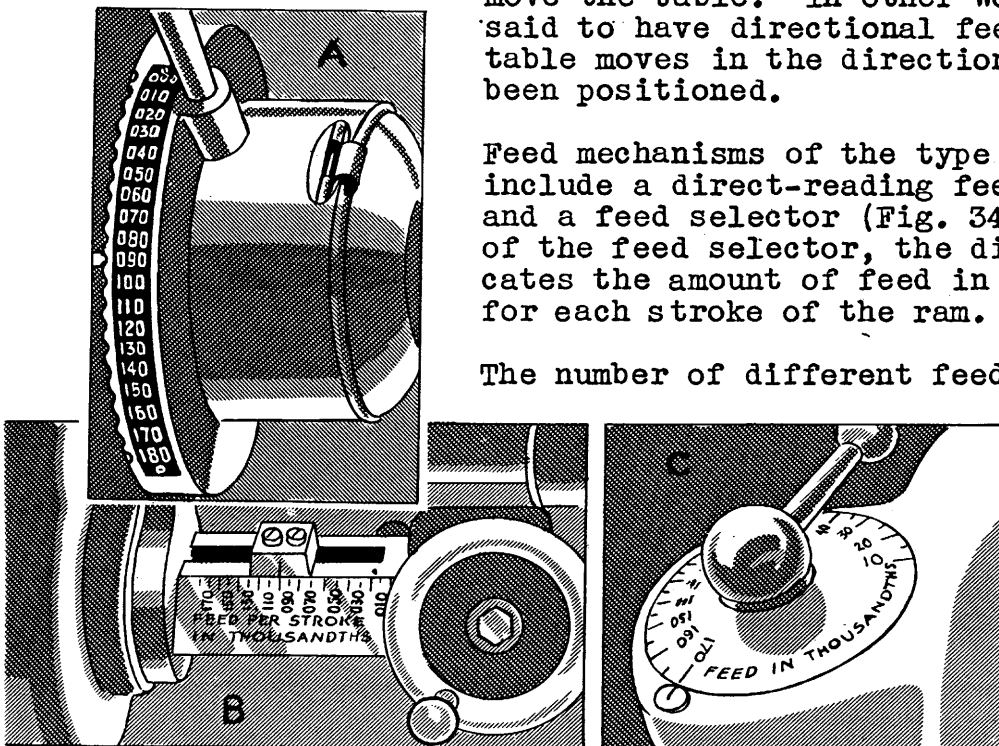

FIG. 34

creases the feed, and movement in the opposite direction decreases it.

Many shapers still in use are not equipped with a direct-reading dial. On machines without this convenience, the pawl is usually adjusted so as to move the ratchet wheel one or more teeth on the return stroke of the ram, depending on the amount of feed desired. Then, even though the machine has no direct-reading feed dial, the amount of feed may be ascertained in thousandths of an inch by noting how far the micrometer collar on the feed screw rotates after each cutting stroke.

DESCRIPTION OF POWER RAPID TRAVERSE

Some shapers are equipped with power rapid traverse, designed to move the table automatically in either direction on the cross rail and at a fixed rate which is several times that of the most rapid feed indicated on the feed dial. In addition, some machines are so designed that this mechanism may be used to move the cross rail up and down on the column.

Its purpose is to bring the work into the proper relationship with the tool as rapidly as possible, using power supplied to the machine instead of using a handcrank (Fig. 35).

When the shaper includes rapid power traverse as a regular part of its mechanism, this unit has been built into the machine. This feature, however, has sometimes been added to the shaper without materially changing its former design. Under these circumstances, the rapid power traverse usually is comprised of an individual motor attached to a unit which engages the feed screw and turns it rapidly (Fig. 36).

Both types of quick traverse operate independently of the rest of the shaper. This supplementary power unit is put into operation by a lever or a button, usually on the operator's side of the machine. Its direction is controlled by the levers used regularly for engaging the automatic feed or by push buttons.

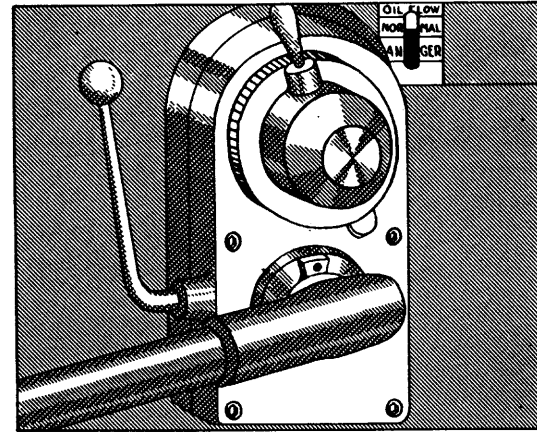

FIG. 35

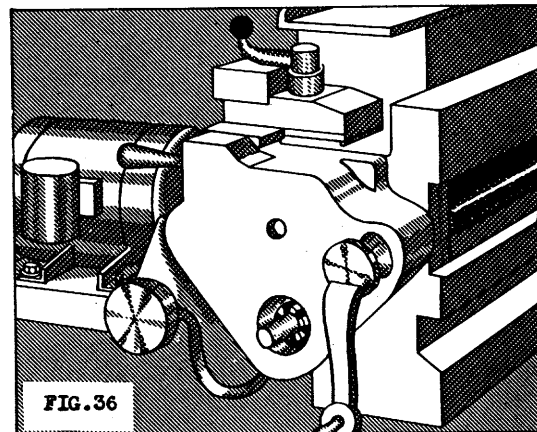

FIG. 36



DESCRIPTION OF THE OILING SYSTEM

Changes and improved designs in shaper construction have been extended not only to the machine itself, but also to the means used to assure an adequate supply of lubricating oil at all times to the parts most likely to be affected by the greatest amount of wear.

Transition of the shaper from a simple cone-driven machine to the modern motor-driven machine tool has been accompanied by a gradual change also in the method employed to supply its working parts with oil, so that from a shaper requiring hand lubrication throughout, it has gradually evolved to one in which many of the bearing surfaces are now automatically oiled. (Refer to page 52.)

This has changed oiling from a function performed more or less regularly by the operator to one performed in a consistent manner by a pressure-lubricating system, and has resulted in placing emphasis on maintaining the oiling system in proper working order rather than on the actual application of the lubricant to the machine part.

Nearly all modern shapers employ a complete circulating pressure system for automatically and continuously supplying oil to each of the important moving parts. Since it would be impractical to extend tubes to all places requiring oil, the more accessible parts and places which do not require a continual supply must still be oiled by the operator (Fig. 37).

Because there are variations in the design of the different makes of shapers, it is impossible to describe exactly or locate precisely all the various points which require oil to be supplied by one method or another. Parts on different makes of shapers, however, which perform the same function, seldom differ to the extent that all similarity disappears. For this reason the operator should be able to recognize the part and lubricate it properly even though the identical one has not been described.

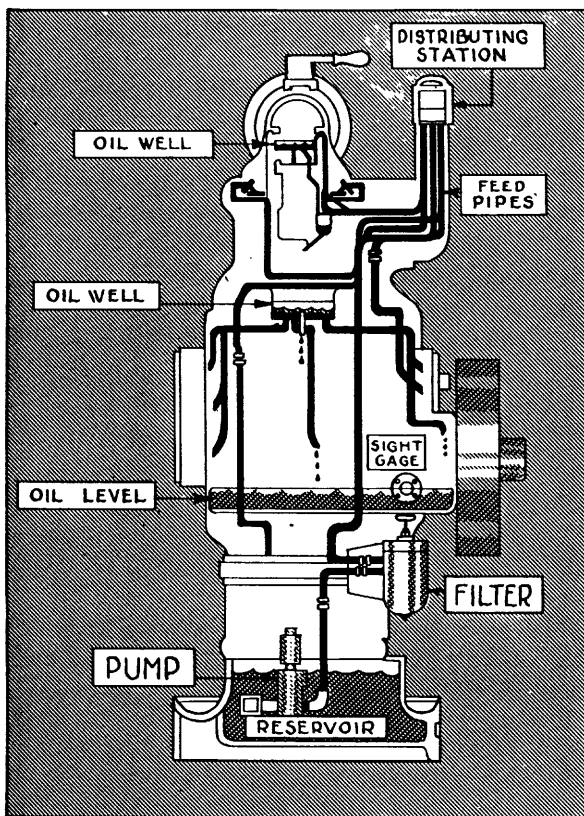

FIG. 37

Either a gear chamber in the column or a space in the base of the machine under the column acts as an oil reservoir. The spaces used for this purpose are practically air-tight, and, consequently, dust and grit are almost entirely excluded therefrom. The reservoir, regardless of its location, is usually equipped with a sight gage to show the oil level within.

A pump, usually of the geared or plunger type, and driven from the constant-speed drive, pumps oil from the reservoir and forces it through tubes which lead directly to the points which require lubrication. Some lubricating systems include a glass-covered flow gage wherein a continuous thin stream of oil remains

visible while the pump continues to circulate oil through the system (Fig. 38).

In a variation of the system described above, the pump, instead of forcing oil to bearings directly, pumps oil to a sight-feed distributing station located on the top of the column. This acts as a central distributing point from which the oil feeds to individual tubes leading to the important parts of the shaper, including the bull-wheel bearing, the drive pinion, the feed mechanism, the ram bearings, the rocker-arm assembly, the transmission, and the cross rail (Fig. 37).

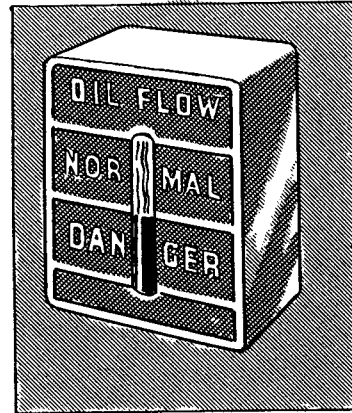

FIG. 38

From the distributing station in which the continuous circulation from the reservoir may be constantly observed, the oil flows to the various parts of the machine and then returns to the reservoir. In order that foreign material picked up in its circulation may settle out before it passes to the supply reservoir, the oil may be returned to an adjoining settling tank, rather than directly to the reservoir.

As an additional precaution against the entrance of foreign material into the lubricating system, the oil may be drawn through a screened enclosure in the reservoir before entering the pump, and then passed through a filter on leaving it.

Four pressure lines lead from the pump directly, or from the distributing station (if one has been included in the system), and terminate at reservoirs located at four corners of the ramway guides. (Refer to page 52). The guide ways for the crank block and other moving parts in the rocker arm, and usually the cross-rail unit also, are lubricated in a similar manner. The flat and round bearing surfaces have deep oil grooves for distributing oil uniformly. Some of these bearing surfaces have been fitted with wipers for retaining oil and for protecting the surfaces from dust and grit (Fig. 39).

The lubrication system for a hydraulic shaper does not require a separate pump. It is usually connected with the hydraulic system which operates the machine, and utilizes oil from this source for lubricating the machine also.

A wide variety of devices is used to convey oil to, and simultaneously to exclude dust and grit from, bearings which have not been connected with a circulating oiling system.

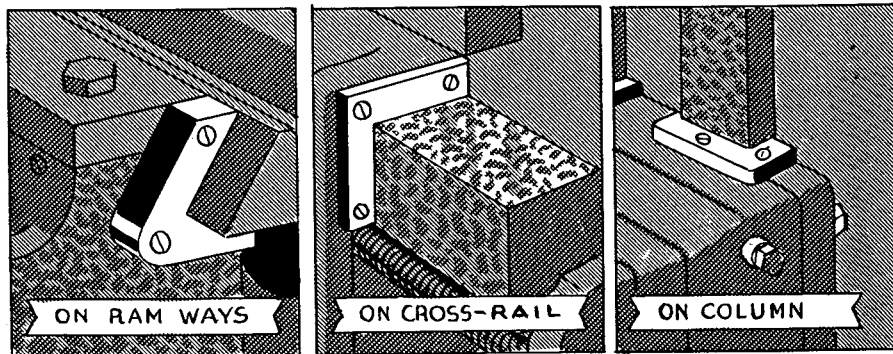

FIG. 39

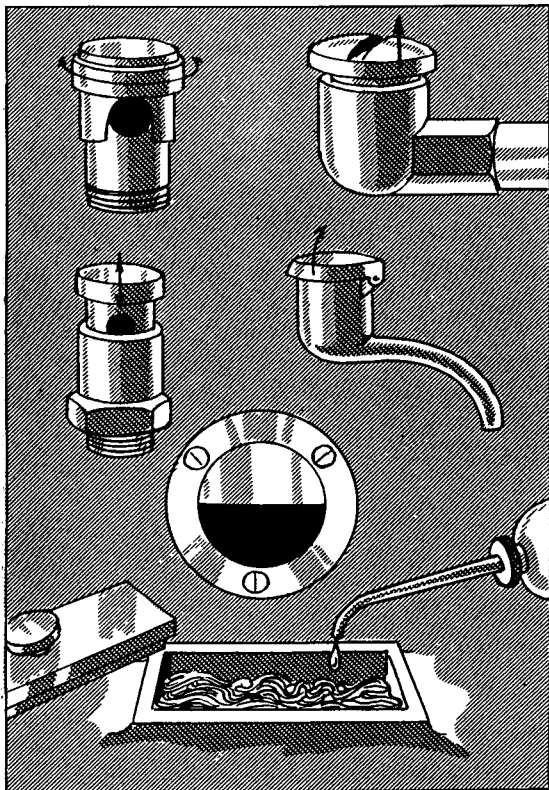

FIG. 40

These bearings therefore must be lubricated by the operator.

The bearings requiring this form of lubrication obviously will be most numerous on the older shapers which were not provided with automatic oiling for any of their parts. Among these bearings will be included those within and about the column, which are automatically oiled in the modern shaper

Usually several types and sizes of oilers will be employed on a shaper for oiling and protecting its bearings, their selection being governed by such pertinent factors as the location of a particular bearing, the amount of oil it requires, etc.

The devices used in connection with machine lubrication have ranged all the way from wooden plugs whittled to fit the holes and intended to exclude chips, to semiautomatic oilers which provide metered lubrication within the limited capacity of the oiler. Several types used more or less commonly on the shaper have been illustrated in Fig. 40.

S E L E C T E D

R E F E R E N C E S

Barrett, J. W.

The Care and Operation
of Machine Tools

Burghardt, Henry D.

Machine Tool Operation,
Part II

Jones, Franklin D.

Machine Shop Training Course,
Vol. II

Shuman, John T.

Machine Tool Work

DESCRIPTION OF *the* HYDRAULIC SHAPER

Unit 1-T52(A) Part II Pages 33 to 46

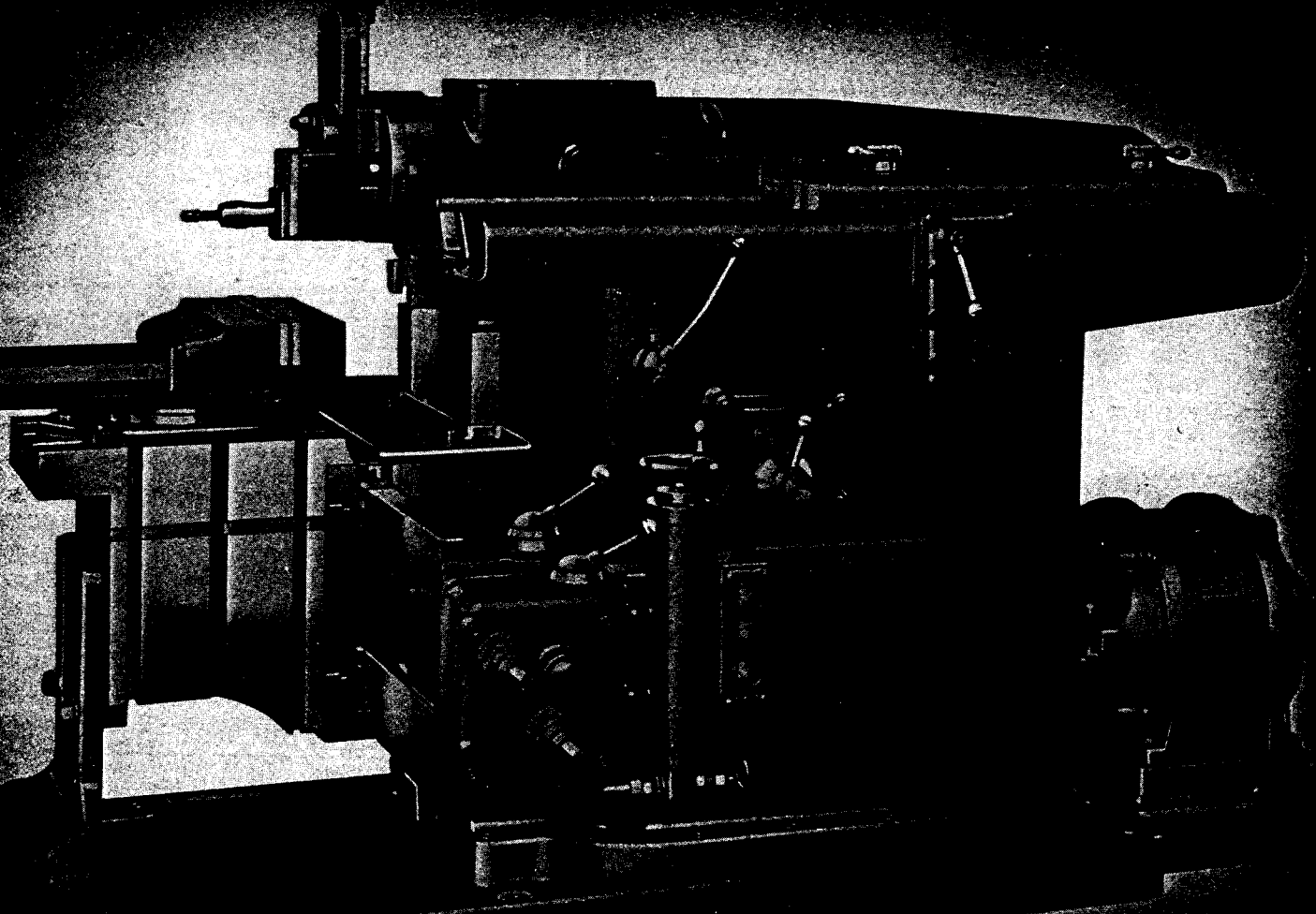

Photo by courtesy of Rockford Machine Tool Co.

UNIVERSITY OF THE STATE OF NEW YORK
STATE EDUCATION DEPARTMENT
BUREAU OF INDUSTRIAL AND TECHNICAL EDUCATION

DESCRIPTION *of the* HYDRAULIC SHAPER

OBJECTIVES OF UNIT

1. To point out wherein the hydraulic shaper differs from the crank shaper.
2. To describe parts and units which are common to the hydraulic shaper and its hydraulic system.
3. To indicate the function of such parts and units.

INTRODUCTORY INFORMATION

Crank shapers and hydraulic shapers differ very little in their outward appearance and in their general construction. The main difference lies in the means used to move the ram backward and forward. The mechanism for actuating the ram on the crank shaper has been described in the previous section; that used on the hydraulic shaper, which operates on an entirely different principle, will be described in this section. Its operation is based on Pascal's law which, in brief, states that a fluid confined to a pipe or other enclosure will transmit applied pressure equally in all directions and to every surface to which it extends.

In the hydraulic shaper the ram receives its reciprocating motion from a piston which is moved backward and forward in a cylinder under the ram by a flow of oil from an electrically driven pump. The oil, under pressure, acts against opposite ends of the piston, alternately, and causes the ram to reciprocate, since it is connected with the piston.

Several valves, each designed for a specific purpose, form a part of the hydraulic system used to operate and control the shaper. One valve, manually operated, starts and stops the shaper; another, mechanically operated, regulates the length of the ram stroke. A third one, whose operation is entirely automatic, controls the volume and regu-

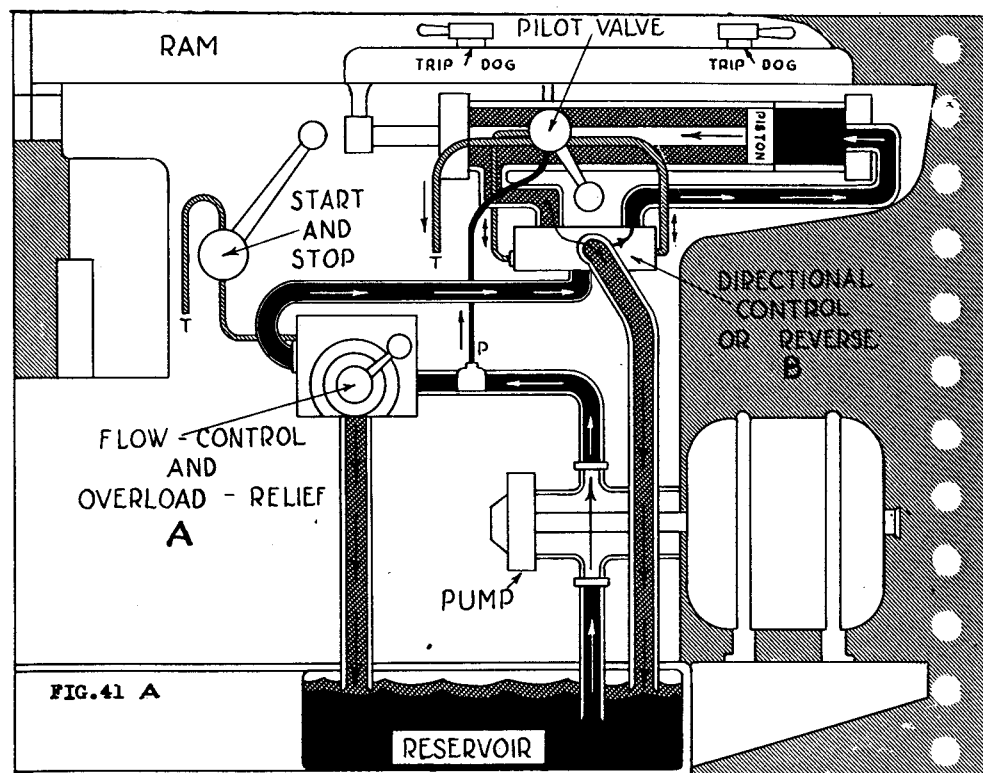

lates the pressure of the oil admitted to the hydraulic system. A fourth valve not only automatically directs the flow of oil to alternate ends of the ram cylinder, but also directs it back to the reservoir. Moreover, both the ram and the automatic feeding mechanisms operate hydraulically on shapers equipped with this type of driving unit.

DESCRIPTION OF A HYDRAULIC UNIT

The hydraulic unit employed to drive a machine tool usually has been supplied by a manufacturer who specializes in this type of equipment and adapts it to the requirements of a particular machine, such as a metal shaper in this instance. The unit comprises a high-pressure pump, usually electrically driven, for circulating the fluid, and valves for controlling its pressure, its volume, and its direction of flow.

It also includes pipes and fittings which connect these parts and make of them a complete circuit wherein the fluid is drawn from the reservoir, directed to the cylinder under pressure, and then returned to its original source (in the reservoir) after the energy it conveys has been exerted on the piston for such time as is required for the ram to complete its forward or return stroke.

The illustrations in Fig. 41 show how a simple hydraulic circuit functions on a shaper. All pipes conveying fluid to the piston, that is, all pipes carrying fluid under high pressure, have been shown in black, whereas those which return the fluid to the reservoir have been shown in gray; the arrows indicate the direction of the flow.

Illustration A indicates the course of the fluid during the forward stroke of the ram. The

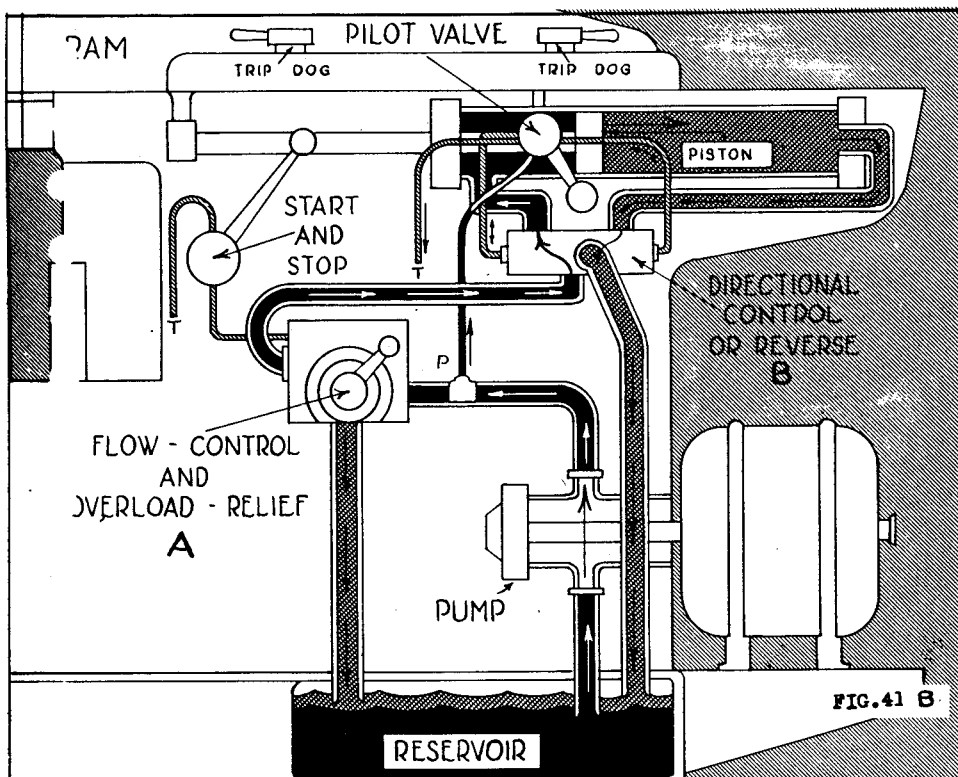

fluid drawn from the tank by the pump, passes through the combination flow-control and relief valve A and on to the directional-control valve B. From here, it has been directed to the right-hand end of the cylinder, causing the piston and the ram connected thereto to move to the left. At the same time, that is, as the piston moves to the left, it expels fluid from the head-end of the cylinder and returns it to the supply tank by way of the directional-control valve.

FIG. 41 B

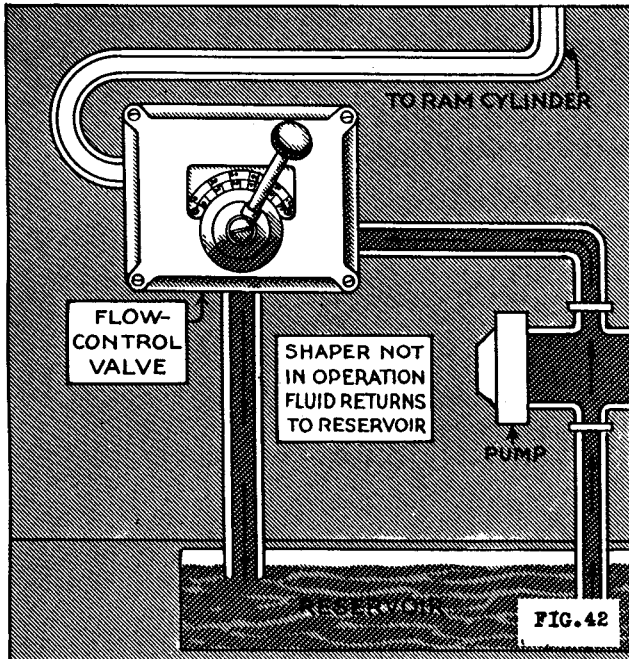

Similarly, in Fig. 41 B, the pipes shown in black depict the course of the fluid during the return stroke of the ram. Now, by means of the directional-control valve, the fluid under high pressure has been directed, not to the right-hand end as before, but to the left-hand end of the cylinder, thereby reversing the direction of the piston travel and causing the ram to move to the right. As it is forced to the right, the piston ejects the fluid from this end of the cylinder, causing it to return to the tank.

When the shaper is stopped for one reason or another, the pump, which is usually of the constant-delivery type, continues to pump the usual volume of oil. Since the oil is not now being utilized to drive the shaper, it must be disposed of in another manner. This

is a function of the flow-control valve (Fig. 42) which operates automatically in conjunction with the start-and-stop lever. This valve opens wide, and the oil returns directly to the reservoir instead of going to the ram cylinder as it does when the machine is in operation.

Briefly, this explains how the hydraulic unit functions. The manner in which the individual parts or units perform their functions will be explained in greater detail under their own headings.

DESCRIPTION OF THE PUMPS

The pump, whether driven electrically or by means of a belt, is usually operated at a constant speed calculated to assure the delivery of fluid in sufficient volume and at sufficient pressure to exceed slightly the maximum demands which may be imposed upon it by the machine of which it has become a part.

Three types of pumps are used more or less commonly for this purpose. They are the gear pump, the vane pump, and the plunger pump, illustrated in Figs. 43 to 46. Each design has features and advantages which make its selection desirable, and each type is made in sizes to fit various working conditions.

The gear pump and the vane pump are known as constant-delivery pumps. As the name indicates, they will deliver a specified amount of fluid at a constant pressure as long as their speeds remain constant.

Since the output of these pumps, regulated by their speeds, has been

calculated to equal or exceed slightly the maximum amount of fluid they will be called upon to deliver during heavy operations and at high machine speeds, it follows that for lighter operations and slower speeds these pumps will deliver considerably more fluid than is actually required. When this condition arises, a relief valve connected to the hydraulic system automatically diverts the excess fluid to the reservoir instead of to a pipe leading to the machine drive.

In contrast with the constant-delivery pumps, the plunger pump of the design shown in Fig. 46 permits the amount of fluid delivered to the hydraulic system to be varied. This is accomplished, not by changing its speed of rotation nor by diverting part of its output by means of a relief valve, but rather by regulating the amount of reciprocating movement imparted to its plungers.

A brief description of each type of pump follows. In design and construction they vary considerably, but each will perform creditably if used under conditions for which it has been designed.

THE GEARED PUMP

This is a type of rotary pump which employs gears with intermeshing teeth for pumping the fluid. The construction of this pump is simple, its only moving parts being the gears. Although spur gears have been used successfully in these pumps, gears with helical teeth result in quieter operation, especially when rotating at the faster speeds required to maintain high pressure in the hydraulic system.

In operation, the gears revolving in the direction indicated by the arrows create a partial vacuum in the space marked V in the gear case. The suction thus created and the atmospheric pressure in the oil reservoir force the fluid into the pump chamber through the intake.

As the revolving gears pass the intake, the fluid fills the spaces between the teeth. The fluid, confined between the outer pump casting and the spaces between the gear teeth, is then carried to the opposite side of the pump chamber and ejected at the outlet. The volume of fluid pumped and the pressure

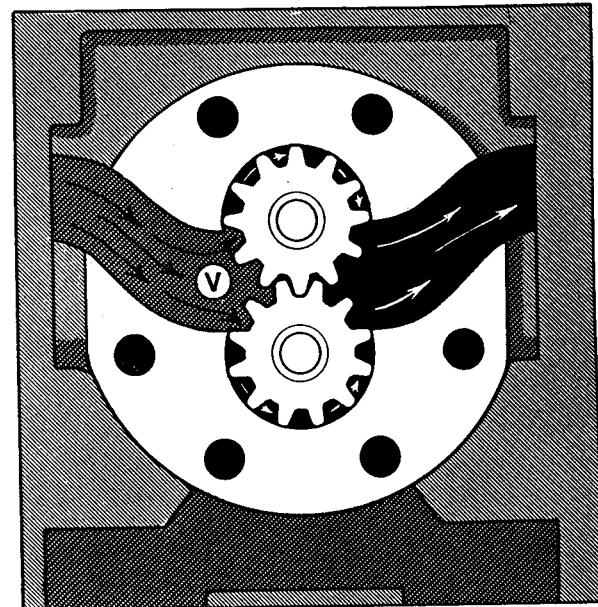
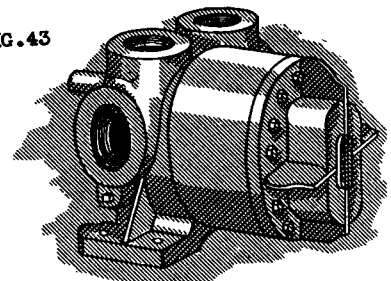

FIG. 43



at which it enters the hydraulic system, depend largely on the speed of the gears.

Pumps of this design perform very satisfactorily when connected directly to an electric motor. When the pump speed resulting from this type of drive is too fast, a speed-reduction unit may be used between the motor and the pump.

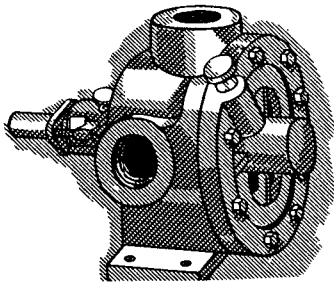

FIG. 44

THE VANE PUMP

The vane pump is also a rotary pump of the constant-delivery type, but instead of gears it employs a rotor equipped with vanes for pumping the fluid. Its principle of operation is quite similar to that of the geared pump, in that the vanes create a partial vacuum in the pump chamber, as do the gear teeth in the geared pump. Similarly, the spaces between the vanes, like those between the teeth in the geared pump, confine the fluid and cause it to be carried from the intake to the exhaust port for ejection into the hydraulic system.

In design and operation, however, the vane pump differs from the geared pump. The vane pump utilizes a rotor with slots in its periphery into which have been fitted vanes which move radially, that is, vanes which slide toward or away from the center of the rotor during its rotation.

The radial movement of the vanes which, combined with the rotary motion of the rotor, is responsible for the functioning of the pump, may be induced by various forms of pump construction. In Fig. 44, for example, the pump chamber is round and the shaft and rotor have been located off center for this purpose. The centrifugal force set up by the revolving rotor and the pressure of the fluid within the pump chamber cause the vanes to slide outward in their slots and hug the surface of the pump chamber. Since the rotor is off center and practically touches the pump body at point A, the vanes are forced into their slots when they are carried past this point. Then, continuing its rotation in a counterclockwise direction from A, each vane gradually emerges from its slot and in so doing enlarges the space B directly behind and thereby creates a suction in this part of the pump chamber.

For obvious reasons, the intake port has been located at this place in the pump chamber also, and the fluid, having been forced into the space between vanes by atmospheric pressure, is then carried around the pump chamber by the vanes and expelled through the exhaust port.

The exhaust port is located opposite the intake port and in that section of the pump chamber in which the action of the vane in its slot is the reverse of its action at the intake port; that is, instead of moving out in its slot, the vane now begins to recede in its slot. This movement, combined with its rotary movement toward point A, causes the space between the pump chamber and the rotor in which the fluid has been trapped, to become smaller gradually, leaving the fluid no alternative but to enter the exhaust port.

Fig. 45 illustrates a type of pump used with the shaper shown on page 33. This is another form of vane-pump construction wherein the rotor is located centrally in the pump chamber, instead of off center, and the radial movement of the vanes in their slots is controlled by the contour of the ring. Instead of being round, the ring opening has been elongated at points O to form two opposing pumping chambers.

The shape of the ring opening causes the vanes to function twice for each turn of the rotor. The vanes are forced into the slots at L and centrifugal force and pressure back of the vanes immediately move them out again and keep them in contact with the ring after they pass these points.

The intake and discharge of fluid occur through ports in side-valve plate bushings located on each side of the pump chamber. The valve openings connect with two intake and two exhaust ports, one of each being required for each pump chamber.

These pumps function well when directly connected to an electric motor. They rely on valves to control the volume of the fluid which is delivered to the ram cylinder when the entire output of the pump, calculated to meet the maximum demand, is not required. The alternate method, that of changing the speed of the pump as more or less fluid is required, is usually impracticable.

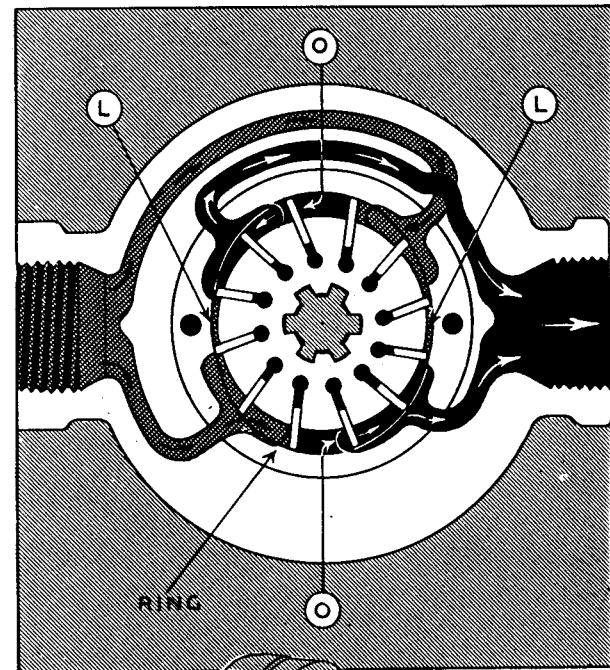
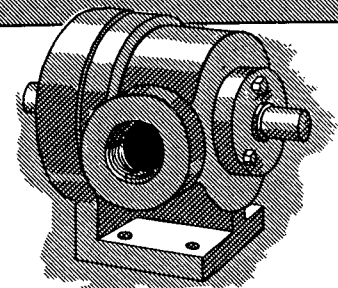

FIG. 45



THE PLUNGER PUMP

Functioning of the plunger pump shown in Fig. 46 is dependent upon the reciprocating (in-and-out) movement of the plungers or pistons in their cylinders. Although pumps of this type are made in constant-delivery models also, one whose output may be increased or decreased, or stopped entirely while the pump is in motion, will be described. Pumps of this kind are known as variable-displacement pumps.

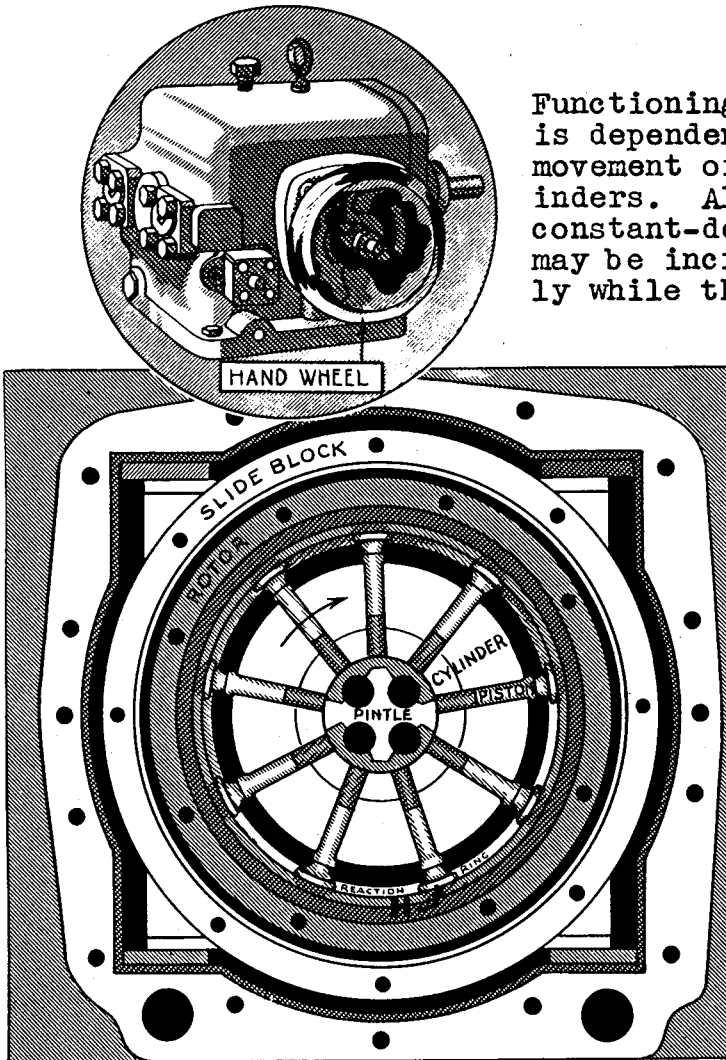

FIG. 46

Fig. 46 shows the interior of such a pump and indicates the relationship one part bears to another when the pump is in neutral, that is, when the pump, even though it is in motion, delivers no fluid. In this position all parts are centrally located around the shaft or pintle.

From the center shaft on out, the parts are these: the cylinder, which revolves on the stationary pintle; the pistons, which revolve with the cylinder; the reaction ring, which forms an integral part of the rotor and revolves as a unit; and the slide block, which may be moved to the left or to the right within the pump casing.

With the pump in motion, and the parts in the position shown in Fig. 46, the cylinder revolves about

the stationary pintle, and obviously carries the pistons around with it.

As a result of the centrifugal force set up by the rapidly revolving cylinder, the pistons move out radially and are forced into continuous contact with the reaction ring. At the same time, of course, the reaction ring and the rotor are caused to revolve also.

Inasmuch as the reaction ring comes in contact with the piston on one side of its conical head only $\frac{H}{2}$, each piston is given a slow partial rotation in its bore, in one direction during one half of the revolution of the cylinder and a partial turn in the opposite direction during the other half revolution.

In addition to the movements already imparted to the pistons, rotary by the cylinder and oscillating by the reaction ring, the pistons must be given a reciprocating (in-and-out) movement in

their cylinders if the pump is to deliver fluid.

In the pump illustrated, this is accomplished by moving the unit comprised of the slide block, the rotor and the reaction ring from its position on center, shown in Fig. 46, to its position to the left of center, shown in Fig. 47, or to any intermediate position between these settings. The handwheel in Fig. 46 controls the movement of the slide block sideways.

Since the shaft or pintle is immovably located in the center of the pump casing, shifting the slide block to the left or to the right brings the reaction ring closer to the cylinder on one side and creates a proportionately larger opening on the opposite side. Then, as the cylinder revolves, the pistons move out during one part of a revolution and are forced into their cylinders during the other part.

During their rotation in the lower half of the revolution, the pistons (1-4 in Fig. 47) move out of their cylinders progressively farther, create a suction and draw fluid into their cylinders as they pass over the openings in the underside of the pintle. This fluid, coming from the intake, has been shown in gray. Arrows indicate the direction of its flow.

During their rotation in the upper half of the revolution, the pistons (5-9 in Fig. 47) are forced into their cylinders gradually by the reaction ring and discharge the fluid as they pass over openings in the upper surface of the pintle. The fluid being discharged (shown in black) is under high pressure.

Obviously then, the amount of fluid which a pump of this type delivers, is governed by the distance the reaction ring has been moved off center, for this determines the distance each piston moves in its cylinder and thus controls the amount of fluid which is admitted to each cylinder.

If the slide block and rotor unit are moved to the right in the pump case, the function of the pistons during each half revolution of the cylinder is reversed, and the pistons (5-9) passing over the opening in the upper surface of the pintle, draw in fluid; those (1-4) passing over the openings in the lower surface of the pintle, discharge fluid.

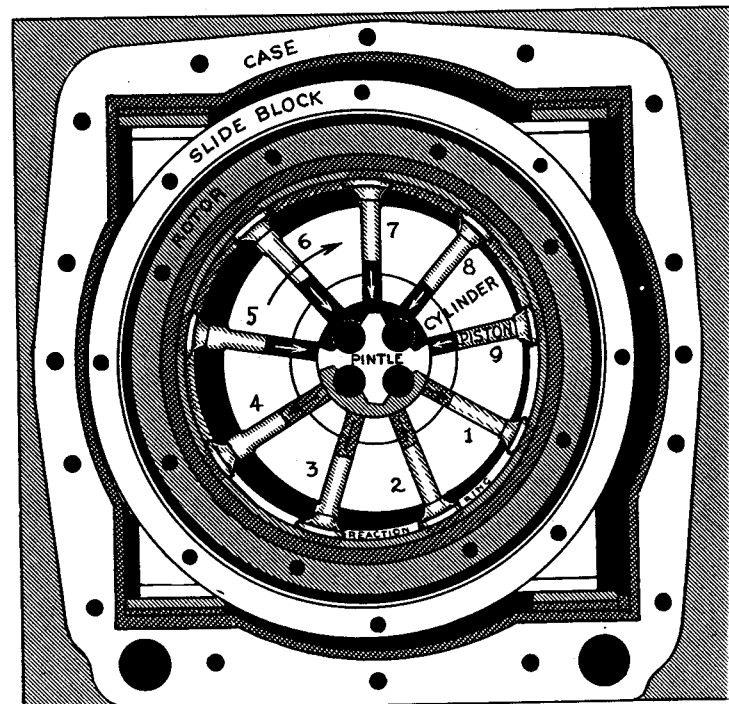
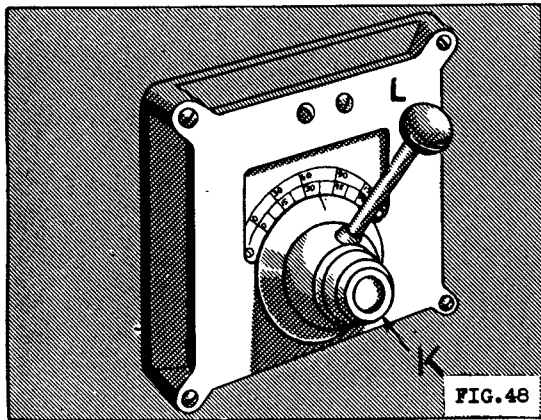

FIG. 47

DESCRIPTION OF THE VALVES

Several valves employed to control the direction of the oil and to regulate its pressure and volume after it leaves the pump, have been described below. The valves have been named and their approximate positions in a hydraulic system for a shaper have been indicated in Figs. 41. These valves are of the plunger or piston type.



THE FLOW-CONTROL AND OVERLOAD-RELIEF VALVE

This is the first valve through which the fluid passes after it leaves the pump. It performs a dual function. First, as a relief valve, it protects the hydraulic system from overloads by limiting the maximum system pressure. For the machine shown, a working pressure of eight hundred pounds per square inch has been recommended, and the valve has been adjusted to open when the pressure developed in the system reaches this figure.

Second, as an automatic flow-control valve, it automatically selects from the fluid coming from the pump that portion which will be allowed to enter the hydraulic system, and that unneeded portion which will be by-passed and returned to the reservoir directly.

In this shaper the speed-control dial (Fig. 48) has been made a part of the volume-control valve, inasmuch as the speed of the machine depends upon the volume of fluid permitted to act on the piston under the ram.

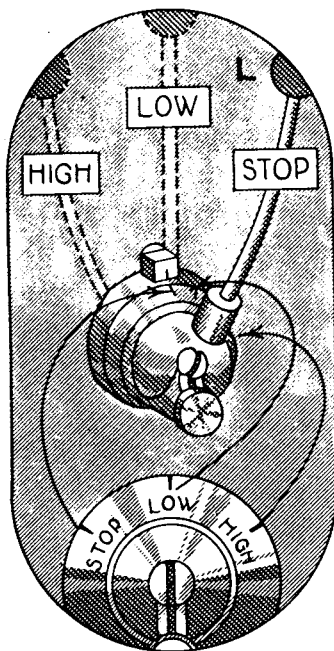

FIG. 49

Lever L controls the volume adjustment of this valve, and its position in relation to the speed-control chart determines and indicates the cutting speed in feet per minute of the ram. Movement of the lever to the left reduces the volume of oil permitted to pass to the ram cylinder and results in a corresponding decrease in ram speed. Conversely, movement of the lever to the right increases the speed of the ram by increasing the flow of oil to its cylinder.

This valve operates to control the pressure and also regulates the volume by by-passing excess fluid, that is, by diverting fluid from the port it would normally enter if needed, to another port which returns it to the reservoir.

THE START-AND-STOP VALVE

The start-and-stop valve (Fig. 49) is operated by lever L which controls both starting and stopping

of the shaper. The location of the valve on the shaper and the position it occupies in the hydraulic system have been indicated on the illustration in Figs. 41. This valve, manipulated by lever L, exercises control over the shaper by actuating and working in conjunction with the flow-control and overload-relief valve to which it is connected with pipes.

With lever L in its "Stop" position, pressure on one side of the otherwise balanced control piston within the flow-control valve, is dropped to atmospheric pressure by allowing fluid to flow back through the start-and-stop valve and on to the tank. This causes the overload-relief valve to open wide and allows the entire pump delivery to discharge back to the reservoir at low pressure until shifting of lever L to an operating position stops the escape of fluid through the valve to which it is connected.

With lever L in one of its operating positions — either "Low" or "High" —, the flow-control valve, instead of diverting fluid, directs it to the ram cylinder in amounts automatically controlled by the position of the speed-control lever on its adjacent speed-control dial, as explained in the section above.

THE DIRECTIONAL-CONTROL OR REVERSE VALVE

The directional-control valve has been placed between the flow-control valve and the ram cylinder (Refer to Figs. 41 for its location in the hydraulic system.) for the purpose of changing the direction of the flow of oil from one end to the other of the ram cylinder in order to induce the ram to reciprocate. This valve receives fluid from the flow-control valve where its volume, as determined by the position of the speed-control lever, and its pressure as well, have been regulated automatically.

This valve (Fig. 50), known as a four-way valve, has four threaded openings or ports which connect with various members of the hydraulic system by means of pipes. Port 1 at the rear, used as an intake port only, admits oil from the pump; port 4, used as an exhaust only, emits oil and returns it to the reservoir; ports 2 and 3, connected to the left- and right-hand ends of the ram cylinder, respectively, serve in both capacities. For example, when port 2 serves as an intake port and port 3 serves as an exhaust (Fig. 51) then the ram moves to the left, and when the functions of these ports become reversed, then the ram moves to the right.

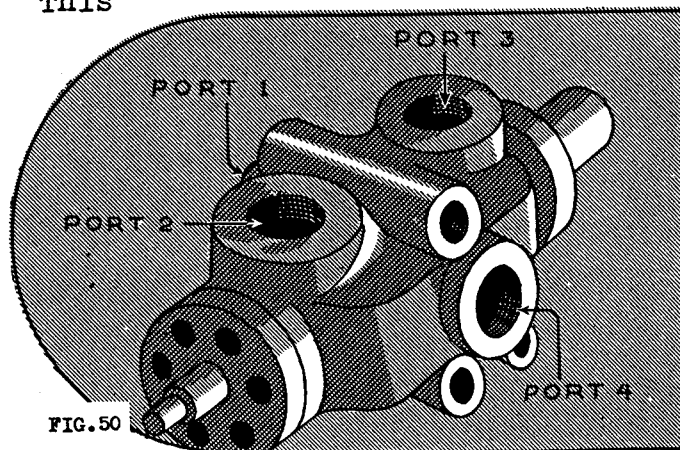

In Fig. 52, the piston within the valve has been moved to the left. In this position the space between its lands forms a con-

nection between the intake (port 1) and port 2 which now becomes an exhaust port. Oil entering the valve chamber under high pressure through port 1 now leaves the valve through port 2, enters the ram cylinder from the left and causes the ram to move to the right.

Furthermore, No. 3 now becomes an intake port, receiving oil forced from the right-hand end of the ram cylinder and directing it through channels C and D to exhaust port 4 to be returned to the reservoir. This indicates the course of the oil through the valve during the return stroke of the ram.

This valve, like most valves used in a hydraulic system, is of the piston or plunger type, and although different makes of valves vary somewhat in construction, all of them function in much the same manner as the one described here. In the valve shown in Fig. 51 a sliding piston of circular cross section controls the passage of oil from the intake to a selected exhaust port by routing it through interconnected channels or grooves within the valve chamber.

The piston, instead of being of one diameter throughout its entire length, has been reduced somewhat in its center section to permit a connection between adjacent ports and channels, lands L₁ and L₂ serving to block channels to which fluid should not be admitted. For example, in Fig. 51, the piston has been moved to the right within the valve chamber. With the piston in this position, oil under pressure enters the valve chamber through channels connected with port 1 in the rear, passes through the space between the lands of the piston, goes on to the opening leading to port 3, and then passes through pipes to the right-hand end of the ram cylinder, causing the ram to move to the left.

Meanwhile, oil draining from the left-hand end of the ram cylinder enters the valve at port 2, and, because of land L₁ on the piston, must pass through channels A and B, and then to port 4 which is connected with the reservoir. The oil follows this course during the cutting stroke of the ram.

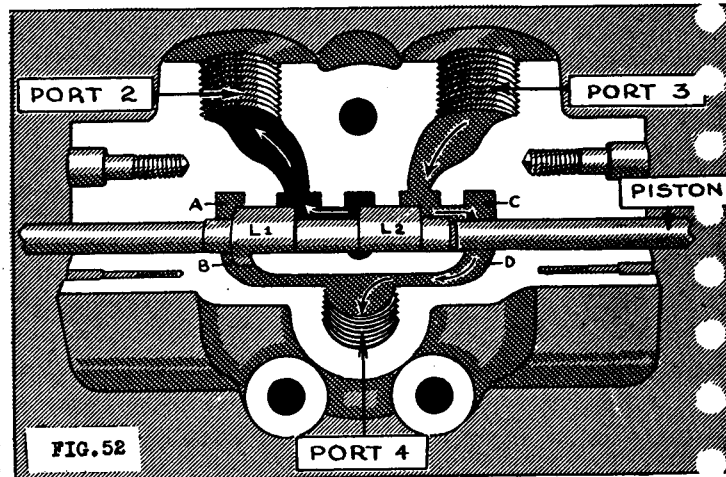
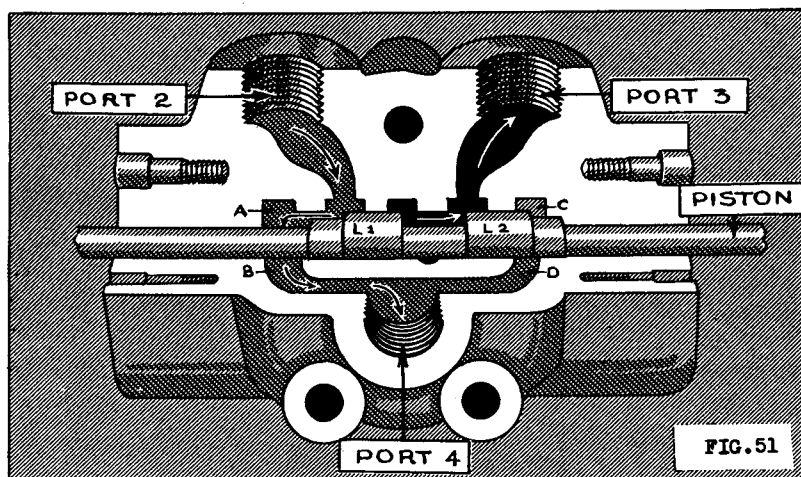

THE PILOT VALVE

The pilot valve, located under the ram, is actually a small valve used to actuate the larger reverse valve which controls the movement of the ram. Although it may be operated manually by shifting lever **L** whenever the ram travel must be reversed quickly, it is usually operated mechanically by the two trip dogs on the ram. These govern both the length of the stroke and its position relative to the work.

As they move back and forth with the ram, the trip dogs give a partial rotation to a projection on the pilot valve at alternate ends of the ram stroke. This action releases a comparatively small amount of oil from one side or the other of the piston in the reverse-valve chamber, causing the pressure to drop automatically. As a result of the unequal pressure on one side, the piston is forced to change its position relative to the valve ports which connect with the ram cylinder as previously explained and illustrated.

The pilot valve exercises its control over the reverse valve by means of four small pipes which connect it with the hydraulic system: one to the high-pressure line **A**; one each **B** to the right and left ends of the reverse valve to permit dropping the pressure on one side or the other of its piston; and, finally, one **C** to the reservoir to carry off the small amount of oil released from the reverse valve. (Refer to Fig. 53.)

When the shaper is in operation, fluid whose pressure has been regulated by the setting of the relief valve and whose volume has been determined by the position of the speed-control lever, passes from the pump to the directional-control valve.

Oil under high pressure leaves the directional-control valve, enters one end of the ram cylinder and exerts its pressure on the ram piston until the pilot valve, actuated by one of the trip dogs, causes a reversal of the flow of oil through the directional-control valve and a corresponding reversal in ram movement. Oil which has spent its energy is in the meantime discharged from the ram cylinder under low pressure and returned to the reservoir for recirculation.

DESCRIPTION OF THE POWER CROSS FEED

The power cross feed moves the table intermittently in a horizontal direction at the beginning of each ram stroke. In the hydraulic shaper a piston-type valve, operated by hydraulic pressure, actuates the feed mechanism which in turn causes the cross-feed screw to make a partial revolution for each stroke of the ram.

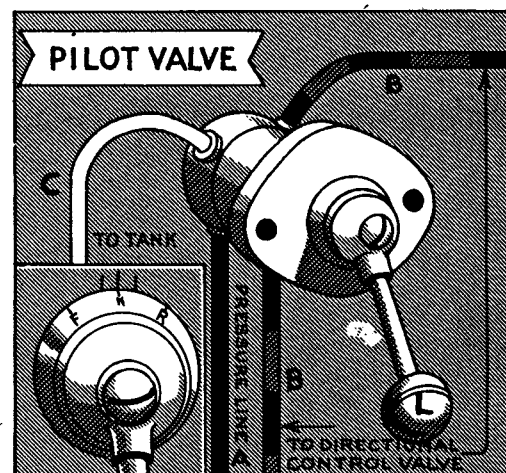

FIG. 53

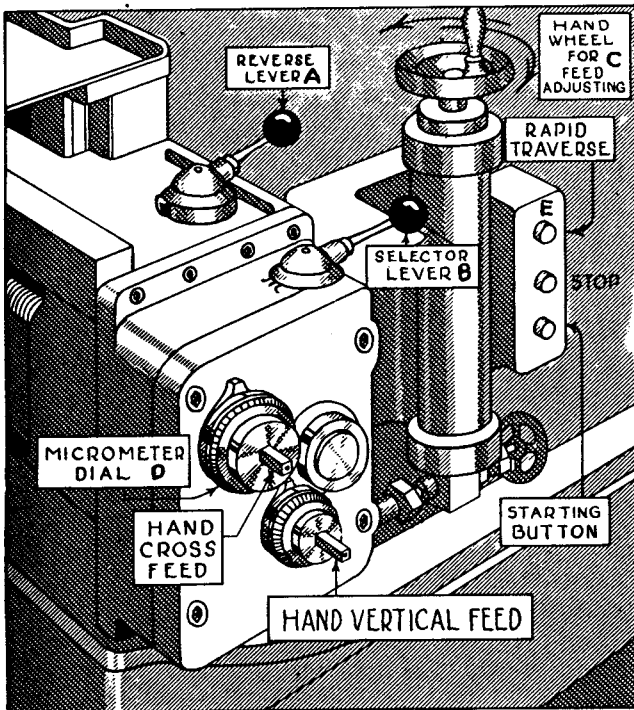

FIG. 54

DESCRIPTION OF POWER RAPID TRAVERSE

An electric motor mounted on the back of the cross rail on the operator's side of the shaper, furnishes the power for rapid traverse of the table.

The operation of rapid traversing is much the same as the operation of the regular feed, but there is one important exception. In addition to the cross power traverse, vertical power traverse is also available. In other words, the reverse lever A, Fig. 54, determines the direction (toward or away from the operator) of the horizontal traverse; likewise, it determines the direction (up or down) of the vertical traverse. The position of selector lever B determines whether the movement of the table is to be horizontal or vertical, depending on whether the word "Cross" or "Vertical" on the hub of the lever is moved to the reference mark.

Push button E controls the motor for power rapid traverse. The table will continue to traverse in the direction previously set while the push button is depressed. Traverse will stop immediately when pressure on the button is released.

When a change in the direction of the rapid traverse is desired, the traverse motor must be stopped before the reverse lever is shifted to the direction desired. This latter precaution must be carefully observed. If it is not observed, the reverse clutch may be damaged.

Levers A and B, Fig. 54, control both the automatic cross and vertical feeds. The beveled edge on lever B, called the selector, bears the words "Cross" and "Vertical." They refer to the feed which may be selected by moving lever B in one direction or the other from its "Off" position.

The beveled edge of lever A, known as the directional-control lever, bears the words "Forward" and "Reverse," alluding to the direction of the cross feed for the table. Lever A also bears the words "Up" and "Down," referring to the vertical power traverse of the cross rail on the column.

The handwheel C is turned to obtain the amount of feed desired for each stroke of the ram. The amount of cross feed obtained may be read on the micrometer dial D on the cross-feed screw.

HOW TO OIL THE SHAPER

Unit 1-P52(A) Part I Pages 47 to 54

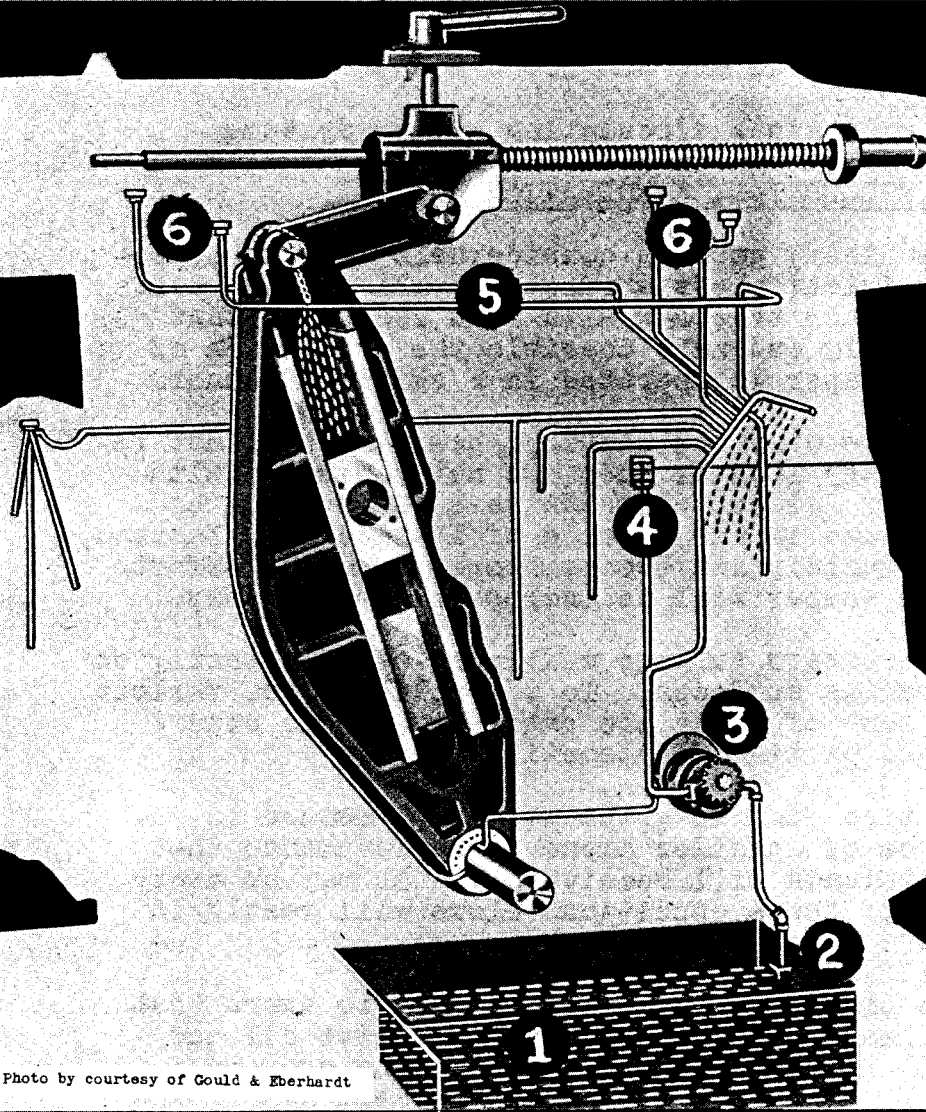

CIRCULATORY LUBRICATION SYSTEM

1. Reservoir
2. Filter
3. Pump
4. Flow Gage
5. Pressure Line
6. Sight Oiler

Photo by courtesy of Gould & Eberhardt

UNIVERSITY OF THE STATE OF NEW YORK
STATE EDUCATION DEPARTMENT
BUREAU OF INDUSTRIAL AND TECHNICAL EDUCATION

HOW TO OIL THE SHAPER

OBJECTIVES OF UNIT

1. To make clear the reasons for oiling a shaper.
2. To give an understanding of how and how often to oil a shaper.
3. To explain how to maintain a circulating oiling system.

INTRODUCTORY INFORMATION

The manufacturer of machinery goes to considerable length to produce smooth and nearly frictionless surfaces on all working parts of the shaper, and fits them together with such exactness that they will function smoothly and make possible the production of accurate work when the shaper is operated in a skillful manner.

Smooth surfaces which move over one another, however, will not remain in this condition very long if they are not separated with a film of lubricating oil. Neither will the ease of movement between surfaces be continued in the absence of lubrication. Instead, the surfaces will wear rapidly and become scored, and the effort required to operate the shaper will be increased considerably.

It obviously becomes necessary to keep a film of oil constantly on both flat and round bearing surfaces. To accomplish this, various means have been used. Some of these are entirely manual; others are partially manual and partially automatic.

Regular care and attention must be given whichever method is employed, for the presence of an oiler alone is no assurance that the bearing to which it leads will receive oil. It may be empty or clogged, and either of these conditions alone will result in a dry bearing.

To lubricate a machine properly, the operator must be aware that every revolving shaft has a bearing which must receive oil and

that flat surfaces moving over one another must be lubricated also. When starting work on a shaper with which he is unfamiliar, the operator, therefore, should locate all the various bearing surfaces. If the bearings are hand oiled, he must determine the location of the oil holes for these bearings and make certain that they are kept well oiled at all times; if they are automatically oiled, continuous circulation of oil must be maintained, and the en-

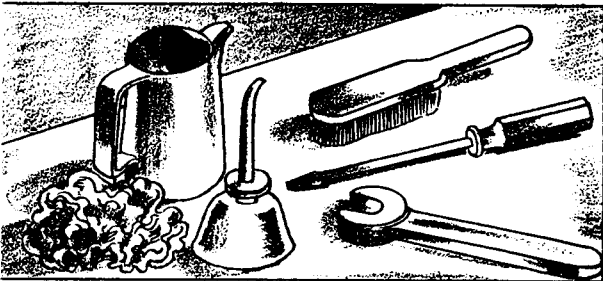

tire circulatory oil system must receive regular attention to assure its functioning in an efficient manner.

Pressure and hand oiling systems are seldom used exclusively for all parts of the shaper, but are frequently supplemented by cascade oiling of the transmission gears and splash oiling of some parts within the column.

TOOLS AND EQUIPMENT

Shaper
Oil Cans

Wiping Cloth
Screw Driver

Brush
Wrenches

PROCEDURE

1. Follow implicitly the directions given on the lubrication chart supplied by the shaper manufacturer, if it is available. This will assure each bearing surface the regular application of the correct quantity and quality of lubricant.

2. Follow the directions given hereafter (page 52), if a lubrication chart is not available so that the shaper will be lubricated with equal assurance, regardless of the method (manual or automatic) used to lubricate the machine.

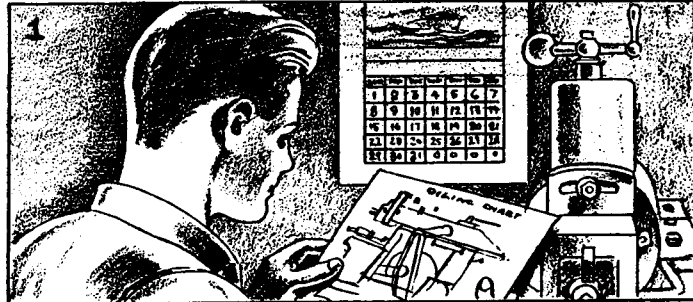

3. Decide questions as to the advisability of oiling an unfamiliar type of construction which has been included on neither the manufacturer's chart nor in the list below, on the basis of statements set forth in the section on the opposing page.

NOTE: Although relieved of some of his oiling duties when the shaper has an automatic oiling system, the operator's duties do not diminish, for he assumes responsibilities pertaining to the maintenance of the system, such as those which follow.

4. Give the circulatory oiling system the following routine daily checkup.

a. Check the oil level in the reservoir by consulting the sight gage connected thereto, or, if a gage has not been used, by removing the fill and level plug in the reservoir.

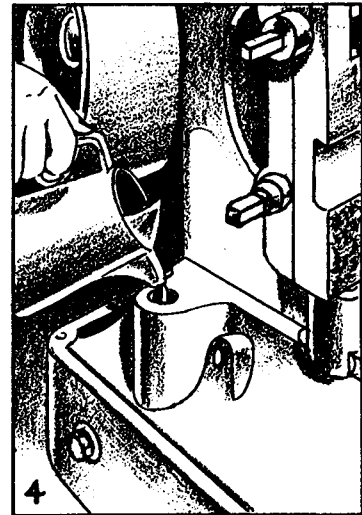

- b. Clean the area surrounding the plug before removing it, in order to prevent the entrance of foreign material to the reservoir.
- c. Add, if needed, enough clean oil of a viscosity recommended by the manufacturer to maintain the proper oil level in the reservoir according to the line on the sight-gage glass; or fill the reservoir to the bottom of the plug, if the gage has been omitted from the system.
- d. Tighten the plug securely to avoid oil leakage, and immediately wipe up oil spilt on the machine to prevent its flowing onto the floor or to preclude its collecting dust.
- e. Check the operation of the pump and the circulation of oil by starting the main drive motor, but with the starting clutch disengaged.

NOTE: Because of differences in construction, it may be necessary on some shapers to engage the clutch in order to set the pump in operation. In this type of construction, however, the speed-change lever should be in neutral; then the ram will not be set in motion.

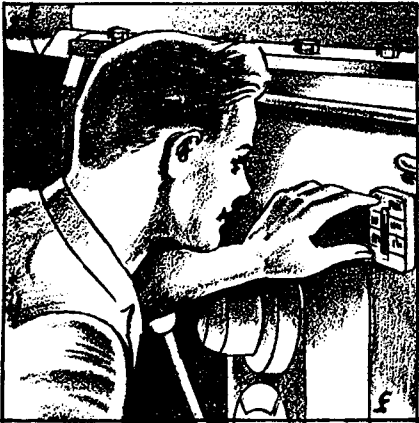

- f. Allow the motor to run while checking the flow of oil through the flow gage and in every sight oiler on the machine.
- g. Stop the motor if for any reason oil is not visible in the flow gage or the sight oilers, and report this condition to your instructor immediately.
- h. Start the machine, but only after it has been set for a slow ram speed and only after making certain that the ram and the tool will clear (not strike) the work in the machine. This is done for the purpose of distributing oil uniformly over the working surfaces before beginning actual machining operations.



CAUTION

If this is the operator's first experience with the shaper, or if he is doubtful of the speed and ram setting, he should seek the assistance of his instructor before setting the machine in motion. (Refer to pages 57 to 59.)

- i. Keep the faces of gages and oilers clean and in good repair, replacing any which become damaged.
5. Follow the directions given below for changing the oil in a circulatory system.

NOTE: The lubricating oil must be changed oftener than indicated below if the shaper operates in surroundings which are unusually dusty, or if the shaper is used for machining operations which are very severe.

- a. Drain the oil from the reservoir at least twice yearly, oftener if discoloration or thinning out makes this advisable.
- b. Examine the condition of the filter (if one has been used), and clean it if necessary.

NOTE: It is a good practice to service the filter whenever the oil in the reservoir has been changed. This may require nothing more than turning a handle to clean the filter plates in some types; in others it may require the replacement of a felt pad which has become loaded with foreign materials removed from the oil. Although the use of a filter may extend the interval between oil changes somewhat, it will not eliminate the need for changes altogether. Discoloration from dirt and thinning out from extended use still make periodic changes a requirement of good lubrication.

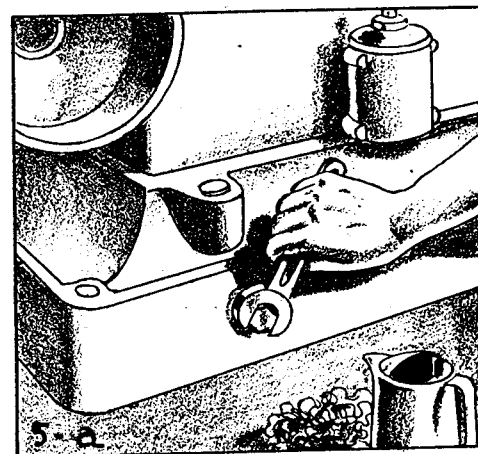

- c. Remove all sediment which has been removed from the oil and has accumulated in the reservoir; then flush the reservoir with kerosene.
- d. Securely close the opening used for draining the reservoir so that oil can not leak from this opening.
- e. Fill the reservoir to the proper level (Refer to 4c on page 50.) with clean oil of the viscosity recommended by the shaper manufacturer. S.A.E. 30 refers to a medium grade of oil.

6. Examine occasionally the felt wipers used on the machine. If they have become loaded with dirt and metal particles, wash them in gasoline, allowing them to dry thoroughly before replacing them.

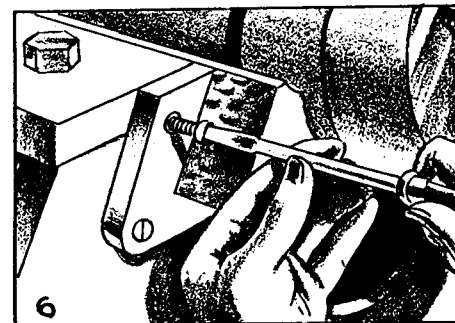

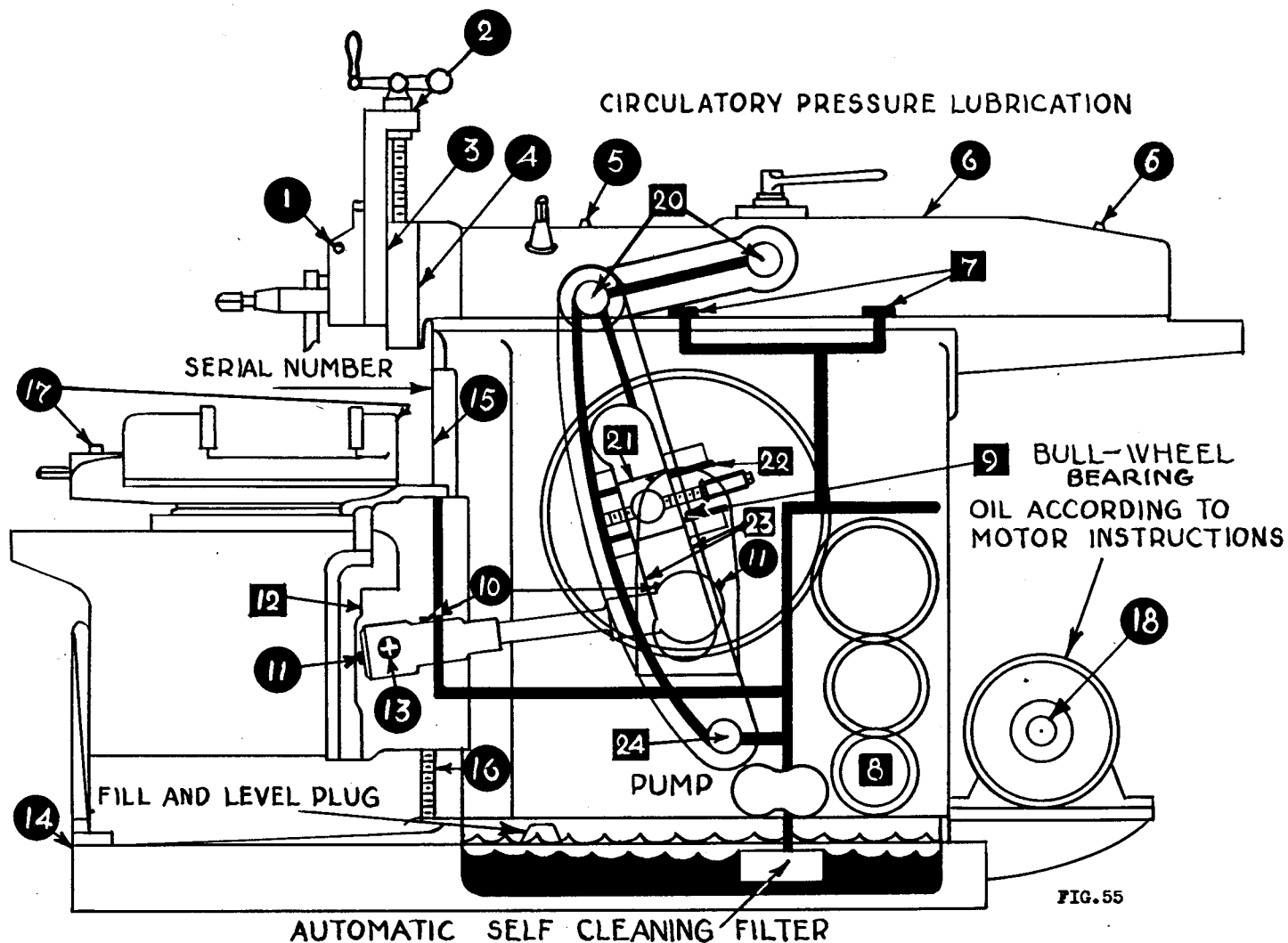

NOTE: All places on a shaper, which must be lubricated in one way or another, have been located and numbered on the oiling chart shown above. In addition, corresponding numbers precede the directions for oiling these places, and, furthermore, the numbers for those places which are usually oiled automatically have been enclosed in a square instead of a circle.

CAUTION Do not oil any part of the shaper while it is in motion, and, as an extra precaution against accidents, do not have the main drive motor in operation either.

1. Apply a drop or two of oil to the oil hole leading to the hinge pin, and to the sides of the tool block which it supports.
2. Oil the down-feed screw and the bearing in the top of the tool slide in which it turns.

3. Raise the tool slide, wipe its dovetailed surfaces clean; then apply a small amount of oil, distributing it evenly over the surfaces with the fingers.
4. Apply a small quantity of oil to the back face of the swivel block when it becomes necessary to change its position.
5. Lubricate the front bearing of the ram adjusting screw.
6. Oil the ram-adjusting screw (through the slot) and also its rear bearing.
7. Oil the guide ways on both sides of the ram after first wiping them with a clean cloth, if felt wipers have not been provided for this purpose.
8. Lubricate the main drive-shaft bearings in both sides of the column.
9. Fill the oiler for the bull-wheel bearing. Since this is a large bearing, it is frequently equipped with a sight oiler which provides metered lubrication.
10. Oil the bearings on both ends of the feed shaft.
11. Supply a small amount of soft grease to the feed reverse gears within the front end of the gear case, and also to the feed mechanism in the rear case.
12. Wipe the top, the front, and the bottom surfaces on one end of the cross rail; apply oil thereto and distribute it with the fingers; then, by turning the handcrank, move the saddle to the end just oiled and repeat the cleaning and the oiling for the other end of the cross rail.
13. Lubricate the threads on the cross-feed screw and its bearing in each end of the cross rail in which it turns.
14. Wipe chips and dirt from the surface on which the table support slides; then apply oil thereto. (Refer to page 11 also.)
15. Thoroughly clean the vertical bearing surfaces on the column; then apply a small amount of oil and spread it uniformly with the fingers before raising or lowering the cross rail.
16. Clean and oil the elevating screw, and, if it rotates in a bearing in the base of the machine, apply a few drops here also.
17. Apply a few drops of oil to the front and rear vise-screw bearings and to the vise screw as well.

18. Maintain the oil at the correct level in the wells which supply oil to the sleeve-type motor bearings, or inject a small amount of soft grease less often if the bearings are of the ball or roller type.
19. Oil the places where the gear shift and clutch levers emerge from the transmission and column. (These places are not shown in Fig. 55.)

CAUTION The following parts are within the column and may be oiled only through an opening in the left side of the column. A door or a removable hand-hole cover is usually provided for this opening, and, although it is wise always to have the machine shut off during oiling, it is imperative now that not only the machine but also the motor be shut off if accidents are to be prevented. In a shaper with a circulating system, these parts would be automatically oiled.

20. Oil the pins in the links which connect the rocker arm with the nut on the ram-adjusting screw.
21. Saturate with oil the felt pad which is usually placed in the pocket of the slide block. Its purpose is to keep the crank pin lubricated.
22. Place a few drops of oil on the parts which comprise the stroke-adjusting assembly: the screw, the gears, and the slide on the bull wheel.
23. Spread oil uniformly over the slide-block bearing surfaces in the rocker-arm slot.
24. Oil the rocker-arm shaft on which the arm pivots.

CAUTION Replace the hand-hole cover for the opening to the column as soon as the oiling within has been completed.

SAFETY PRECAUTIONS FOR OILING THE SHAPER

- Do not oil the shaper when it is in operation.
- Do not fool around the machine while it is being oiled.
- Avoid leaning against the machine; it may result in accidental starting.
- Wipe all excess oil from surfaces near oiling places on the machine and wipe up any oil spilled on the floor.
- Remove oily waste to a covered receptacle to eliminate a fire hazard.
- Use an oil can with a bent spout and place it where it can cause no personal injury.

HOW TO OPERATE AND CARE FOR THE SHAPER

Unit 1-P52(A) Part II Pages 55 to 74

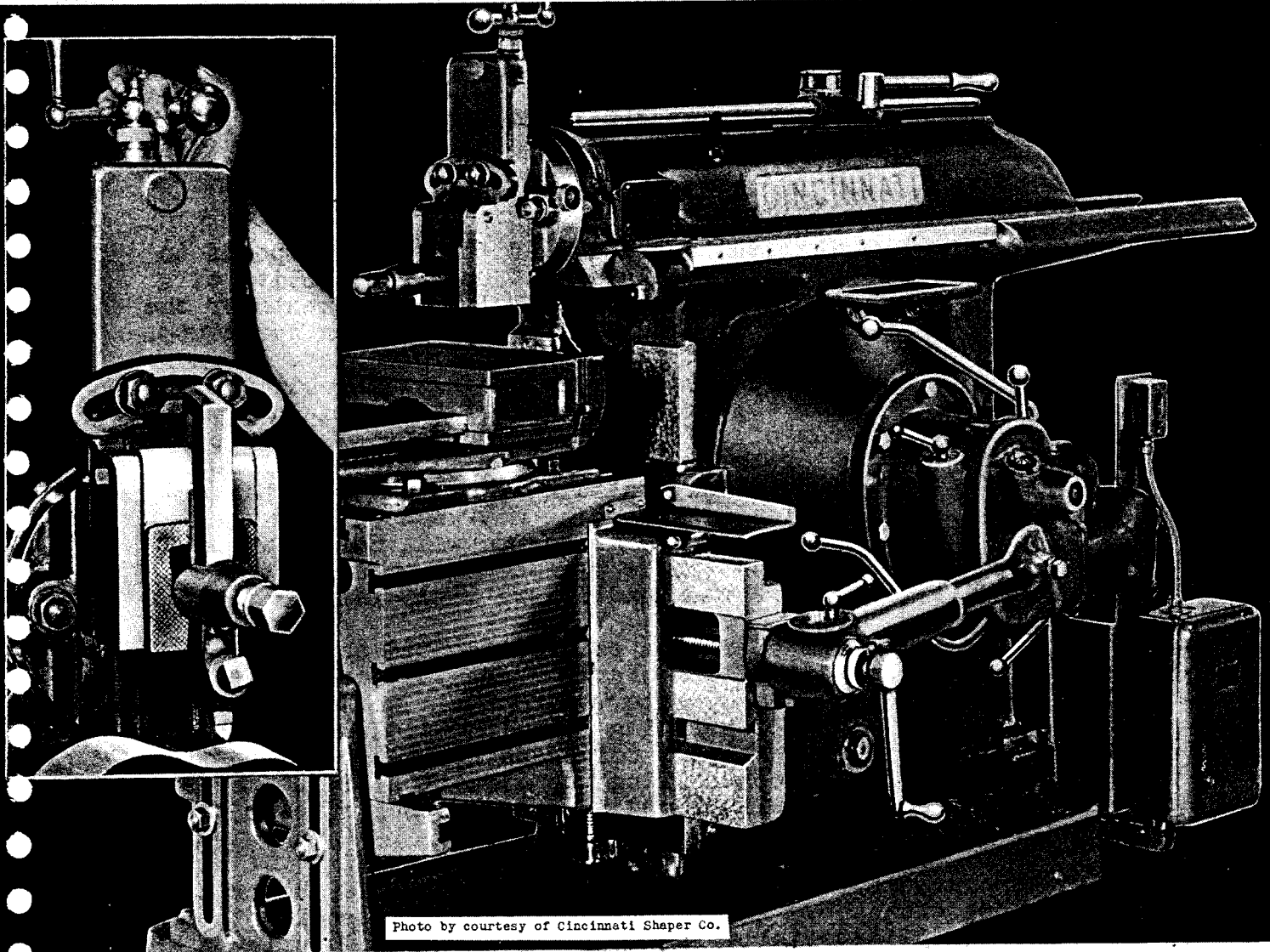

Photo by courtesy of Cincinnati Shaper Co.

UNIVERSITY OF THE STATE OF NEW YORK
STATE EDUCATION DEPARTMENT
BUREAU OF INDUSTRIAL AND TECHNICAL EDUCATION

HOW TO OPERATE *and* CARE *for the* SHAPER

OBJECTIVES OF UNIT

1. To become familiar with the operation points on the shaper.
2. To show how to use the controls on the shaper.
3. To show how to care for the shaper and its accessories.

INTRODUCTORY INFORMATION



Skillful operation of the shaper depends to a considerable extent upon the ability of the operator to control the movements of the various parts of the machine with certainty. Familiarity with the controls plays an important part in developing this ability. For this reason, and for the additional reason of safety, it is important for the operator to become familiar with both the hand and the automatic controls early in his experience so that he may know exactly what action of the mechanism will result when each button is pressed and when the various levers and handles are manipulated.

The operation points, located on the right side of the shaper where they are accessible to the operator without his moving from the usual operating position, include levers for starting and stopping the shaper, for changing the speed and the position of the ram, for controlling the direction of the feeds, and, on shapers provided with rapid power traverse, a lever or a push button for engaging this mechanism also.

Closely associated with the skillful operation of the shaper are its proper use and care. Experience proves that attention to these factors aids materially in extending the period during which the shaper retains its original accuracy and ease of operation. Procedures which will assure these results will be recommended in this section.

TOOLS AND EQUIPMENT

Crank or Hydraulic Shaper

PROCEDURE

HOW TO START AND STOP THE CRANK
SHAPER

Several common types of drives are employed on the shaper, and, consequently, the particular type of drive determines the means used for starting and stopping the machine.

The cone-driven shaper, for example, usually receives its power from an overhead countershaft equipped with two identical pulleys. One is known as a tight pulley, since it is keyed to the countershaft and is used to drive the upper cone pulley; the other, known as a loose pulley, revolves without turning the countershaft and serves only to retain the belt when the shaper is not in operation.

To start the machine, the belt is shifted from the loose pulley onto the tight pulley by a fork whose movement is controlled by means of the shipper handle extending down from the countershaft to a position within reach of the operator. The shipper handle should be moved over deliberately so as to allow the belt to move onto the tight pulley slowly and thus bring the machine up to speed gradually.

To stop the shaper, the belt is again shifted to the loose pulley. The width of the drive pulley on the line shaft must be equivalent to the combined width of the tight and loose pulleys, for the belt utilizes one side of the face on the drive pulley when it is guided onto the loose pulley and the other side when it is guided onto the tight pulley.

Hurried starting of the shaper should be avoided, for it produces two undesirable results: belt slippage and the noise which invariably accompanies it. Both can be avoided by starting the shaper without undue haste.

Such deliberation in shifting, however, is unnecessary when the machine is being stopped, since at this time the belt is simply guided onto the loose pulley; in contrast, when the machine is being started, parts having considerable weight must be set in motion, and this cannot be done instantly.

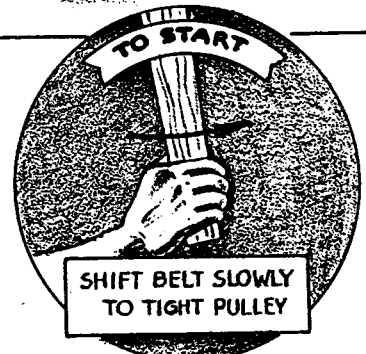
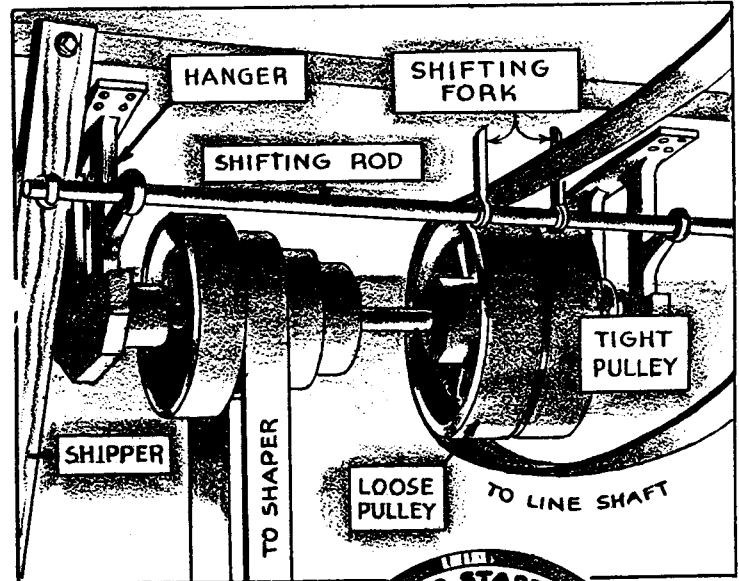
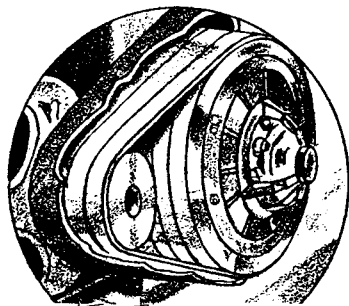
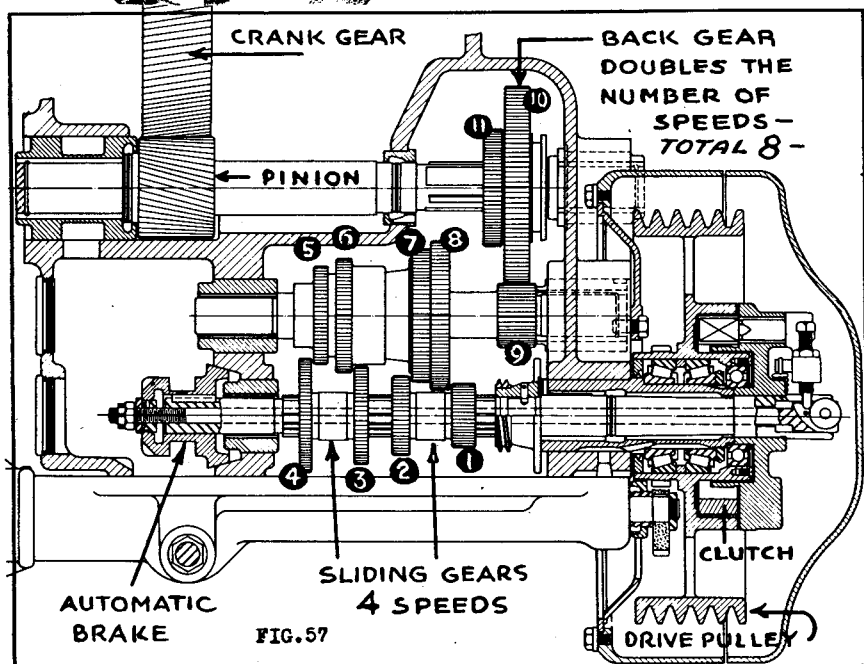

FIG. 56



Instead of a cone pulley, some shapers employ a single step pulley for driving the machine. This single pulley may be driven from a line shaft, or from a countershaft directly above the shaper; or, in an arrangement known as direct drive, by a constant-speed electric motor which is usually located at the rear of the shaper and frequently on an extension of the base casting.



Motion is transmitted from the single pulley to the mechanism which actuates the ram by a series of gears. The number of different combinations in which these gears can be arranged within the gear box by means of an external lever, determines the number of speed changes possible for the series.

A clutch on the main drive shaft permits starting and stopping the shaper independently of the motor. This is accomplished by a short movement of a lever which extends from the clutch to a place easily accessible from the oper-

ator's usual position. Shifting the clutch lever in one direction engages the clutch and starts the shaper; shifting it in the opposite direction disengages the clutch and stops the ram at any part of its stroke. (Refer to Fig. 57.)

Most shapers using a single-pulley drive are provided with a brake, also located on the main drive shaft and on the end opposite the clutch, to permit almost instantaneous stopping.

On some shapers, application of the brake is automatic, occurring coincidentally with the disengagement of the clutch; on others, the brake is applied by a slight pull on the clutch lever after the clutch has been disengaged.

HOW TO START AND STOP THE HYDRAULIC SHAPER

A single lever is mounted on the right side of the column for controlling both the starting and the stopping of the shaper. Another lever, which is interconnected with the one on the right side, per-

mits control of the machine from the left side when this is necessary. Before either of these levers can function for starting, however, it is necessary to start the electric motor which operates the pump for the hydraulic system.

In addition to "Stop" which appears at the index line when the machine is at rest, the words "Low" and "High" also appear on the hub of the starting lever. They refer to the series of low speeds and the series of high speeds indicated on the speed-index plate (page 94) which are made available when the lever has been shifted to one of the positions designated on its hub. (Refer to Fig. 49.)

Moving lever L to the left so that it assumes an approximately vertical position, places the word "Low" adjacent to the reference line and starts the ram moving in the low-speed range.

Movement of the lever beyond this point is limited by a spring pin attached to knob K and engaged in a slot under the hub of the lever. A light pull on knob K, however, together with a turn of approximately 180° , withholds the spring pin from the slot which limits its movement. Consequently, the starting lever can now be moved farther to the left and the word "High" placed adjacent to the reference mark. This puts the ram into the high-speed range of movement. To stop the ram, this lever is shifted toward the rear of the machine to a position where "Stop" appears opposite the reference mark. To stop the electric motor which drives the hydraulic pump, it is necessary merely to push its control button. (Refer to Fig. 54.)

HOW TO CONTROL MOVEMENT OF THE TABLE ON THE CRANK SHAPER

Crosswise movement (horizontal) of the table in either direction over the cross rail is obtained by turning the hand crank on the end of the cross-feed screw in one direction or another. Clockwise rotation of the crank, which is furnished with the machine, moves the table away from the operator, and, conversely, counterclockwise rotation moves the table toward the operator.

Automatic movement of the table (automatic feed) in a crosswise direction is controlled by a lever or a knob located on the cross-rail unit. The feed is engag-

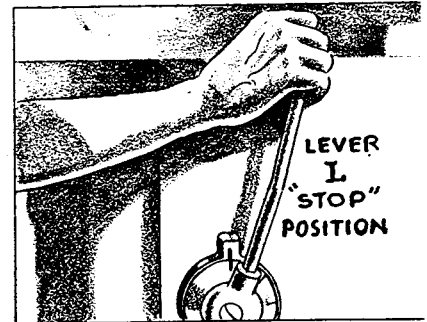

FIG. 58

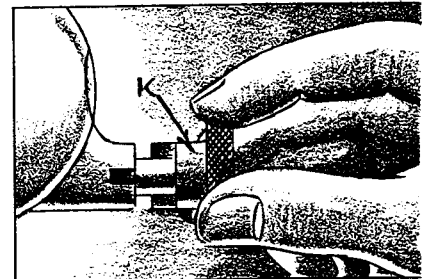

FIG. 59

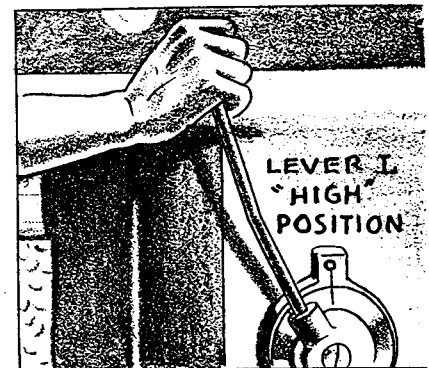
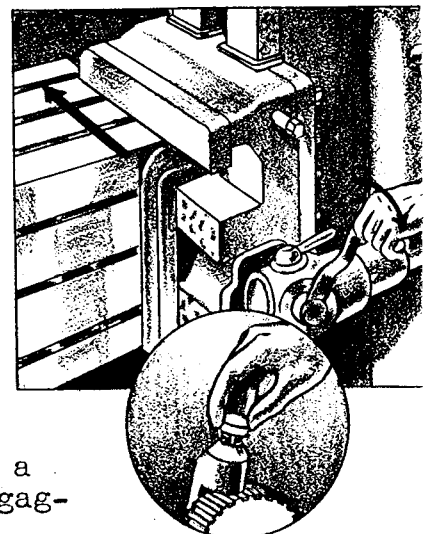

FIG. 60



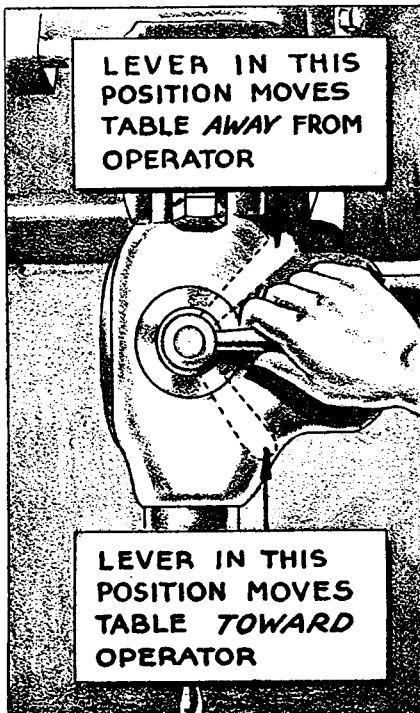

FIG. 61

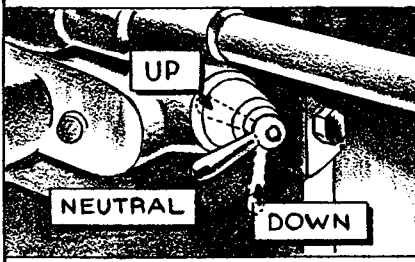

FIG. 62

ed, disengaged, and reversed by changing the position of the knob or lever. The manner in which this is accomplished on the cone-driven shaper has been fully explained on pages 23 to 27.

On the modern shaper which uses a bevel-gear reverse mechanism similar to the one shown on page 28, the table moves in the direction in which the feed lever has been moved. Setting this lever away from the machine, feeds the table toward the operator. Setting the lever in the opposite direction, feeds the table away from the operator. The feed is disengaged by setting the lever in the midway position. The shaper is said to have directional control when the table feeds in the direction in which the feed lever has been moved.

The amount of feed per stroke or, in other words, the distance the table moves over for each stroke of the ram, may be regulated on all shapers, but in various ways, several of which have been explained on pages 23 to 28. The location of the mechanism used for regulating the amount of feed is approximately that of the one shown in Fig. 26.

Vertical movement of the table (up or down) on the face of the column is secured by turning the elevating shaft in one direction or another by means of a hand crank placed on its end. The elevating shaft protrudes from one side or the other of the cross rail, just below the cross-feed screw. The detailed instructions on page 77 should be followed when the table must be moved vertically.

HOW TO CONTROL MOVEMENT OF THE TABLE ON THE HYDRAULIC SHAPER

The table on the hydraulic shaper, like the one on the crank shaper, may be fed by hand in either horizontal direction by turning the hand crank on the end of the cross-feed screw in one direction or the other.

The cross rail, too, may be moved by hand in either vertical direction, to raise or lower the table, by placing the handcrank on the elevating shaft and turning it in whichever direction will produce the desired vertical movement of the cross rail on the column.

A somewhat different method, however, is employed for engaging the automatic cross feed on the hydraulic shaper shown on page 33, from those methods used for this purpose on any of the crank shapers whose feeding mechanisms have been described on pages 23 to 28.

The location of the feed levers on the hydraulic shaper and their placement for engaging and disengaging the cross feed, have been indicated in the illustration on page 46. Detailed instructions for applying the feed and for regulating the amount of feed per stroke, accompany the illustrations on pages 95 and 96.

HOW TO OPERATE THE RAPID POWER TRAVERSE ON THE CRANK SHAPER

Rapid power traverse has been described on page 29. Its operation is controlled by a lever on the operator's side of the shaper when the rapid-power traverse unit is built-in and forms an integral part of the feed mechanism. When the rapid-traverse unit functions independently of the regular feed mechanism, however, it is usually operated by an individual electric motor and controlled by push buttons. (Refer to page 29, Fig. 36.)

On the built-in type, the same lever that engages and controls the direction of the table during feed, also controls the direction of the power rapid traverse.

On some shapers the direction of the power rapid traverse is opposite to that of the feed set. When a unit which functions in this manner is engaged, it serves as a quick return, in that it moves the table over rapidly after a cut has been completed, and places the work in readiness for another cut.

On other shapers, however, instead of functioning as a quick return, the rapid power traverse functions in the same direction when engaged as does the feed — in the direction in which the feed lever has been moved. In both types, however, the direction is reversed by reversing the position of the feed lever.

To operate the built-in type of power rapid traverse, engage the cross feed by shifting the feed lever in the desired direction. Then pull out on the rapid traverse lever and hold it in this position while the table moves over the required distance. Release the lever to stop the rapid movement of the table. Release of the control lever automatically disconnects the rapid power traverse and reinstates the regular feed which becomes operative immediately (Fig. 63).

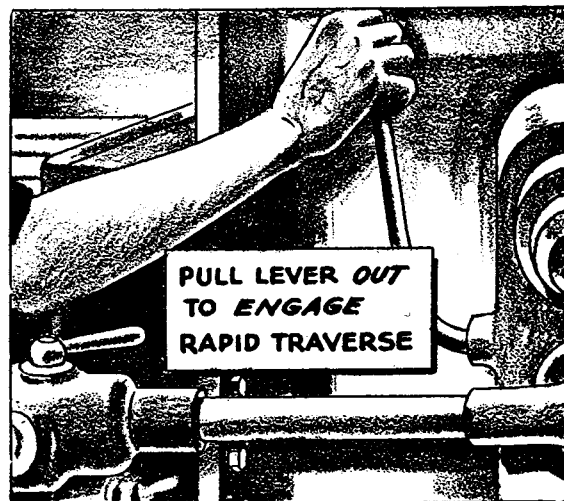

FIG. 63

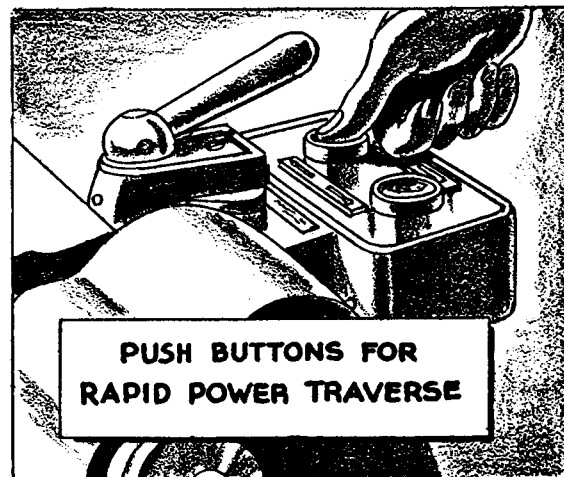

FIG. 64

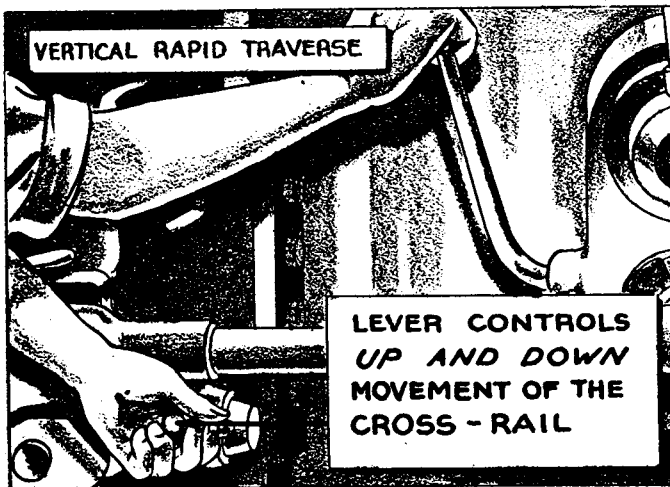

FIG. 65

A somewhat different procedure is necessary when the shaper is equipped with an independent unit for the rapid power traverse. This unit is usually connected to the left-hand end of the cross-feed screw through a worm and worm wheel. Inasmuch as the direction of rotation of the driving motor may be reversed, movement of the table on the rail may be in either direction. (Refer to page 29.)

The control is through a "Forward" and a "Reverse" push button conveniently located at the operating end of the cross rail. The table may be traversed in either direction by simply pushing the button for the forward move-

ment or the one for the reverse movement, as desired. This unit may be operated while the machine is at rest. (Refer to Fig. 64.)

In addition to horizontal power rapid traverse of the table, power rapid vertical traverse of the rail on the column is also available on some shapers to elevate or lower the work table rapidly.

The same single control lever used for the horizontal traverse is also used to engage the vertical traverse. The direction of the vertical traverse, whether up or down, however, is selected and indicated by another directional-control lever located at the rail (Fig. 65). A safety device is usually incorporated in the feed mechanism to prevent damage during operation of the rapid traverse.

CAUTION Before using power rapid vertical traverse on either the crank or the hydraulic shaper, read and follow directions No. 1 through No. 6 on page 77 pertaining to the adjustment of the cross rail. Then, after the rail has been adjusted, follow directions No. 9 and No. 10 on page 78.

HOW TO OPERATE RAPID POWER TRAVERSE ON THE HYDRAULIC SHAPER

Rapid power traverse on the hydraulic shaper shown on page 33 is not actuated by pressure of the fluid in the hydraulic system, but instead by an electric motor mounted on the back of the cross rail on the operator's side of the shaper. The motor, and consequently the rapid traverse, operates under the control of push button E (Fig. 66).

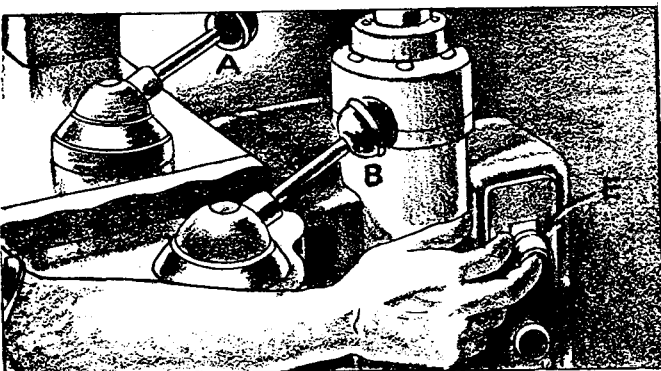

FIG. 66

Except for the additional requirement — that of depressing button E — operation of rapid traversing in a horizontal direction is the same as the operation of the regular cross feed which has been explained on page 95.

In addition to the cross power traverse, vertical power traverse is also available on this shaper for raising and lowering the table. The operation of vertical traverse, too, is controlled by push button E, but its operation in this direction requires a change in the position of the selector lever B, and, in addition, may require a change in the position of the directional-control lever A also.

For vertical traverse, the selector lever B is moved in a counter-clockwise direction. Its movement in this direction brings the word "Vertical" on its hub to the reference line, and indicates that subsequent movement of the table will be either up or down.

The directional-control lever A is then moved in one direction or the other from its "Off" position so that the word "Up" on its hub is in registration with the reference mark if the table is to be raised, or so that the word "Down" is opposite this mark if the table is to be lowered.

CAUTION Before depressing the push button which controls the operation of the rapid vertical traverse, make certain that the clamps for holding the rail to the column, and also the clamps or bolts which hold the table support to the table, have been loosened.

Follow directions No. 1 through No. 6 on page 77 pertaining to the adjustment of the cross rail.

After the rail has been raised or lowered as desired, follow directions No. 9 and No. 10 on page 78 for again clamping the rail and table support in position.

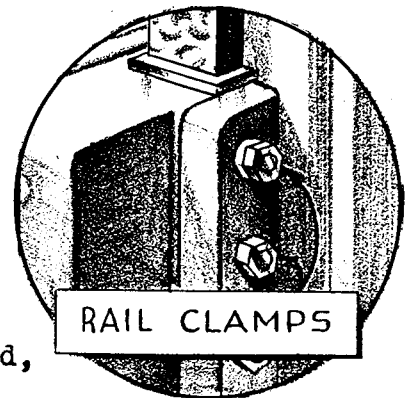

FIG. 67

HOW TO CONTROL MOVEMENT OF THE RAM ON THE CRANK SHAPER

As is the case with all other controls indicated so far, those which have to do with the length of the ram stroke, the placement of the stroke with relation to the cut, and the speed of the ram, are also located on the right side of the shaper. This location makes them readily accessible from the operator's usual position.

For example, the stroke may be lengthened or shortened by placing a handcrank on the stroke-adjusting shaft (Fig. 68) and by turning it in one direction or the other, as required. A stroke-indicator dial, or a scale adjacent to the ram, indicates when this

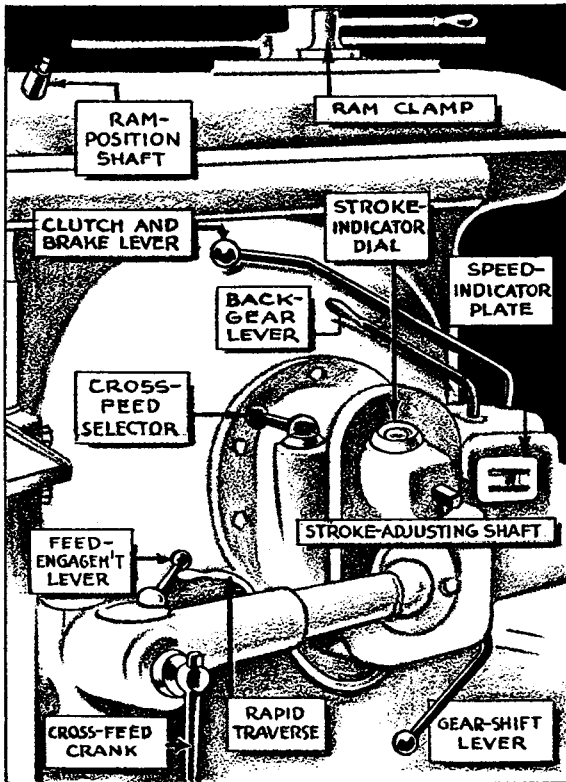

FIG. 68

setting has been made correctly. Detailed instructions for making this adjustment have been given on pages 79 and 92.

After first loosening the ram clamp, the stroke may be located over the cut by turning the ram-positioning shaft by means of a handcrank. Obviously, the direction in which the shaft must be turned will be determined by the direction in which the ram must be moved, whether forward or backward from its present position. For detailed instructions for positioning the ram, refer to pages 81 and 92.

Any of the eight ram speeds indicated as strokes per minute on the speed-indicator plate are made available by locating the gear-shift lever and the back-gear lever in their designated positions. Four of these speeds are obtained by moving the gear-shift lever when the back-gear lever occupies one of its positions. Four different speeds are obtained by moving

the back-gear lever to its alternate position. Step-by-step instructions for changing the speed of the shaper have been given in the section beginning on page 82.

HOW TO CONTROL MOVEMENT OF THE RAM ON THE HYDRAULIC SHAPER

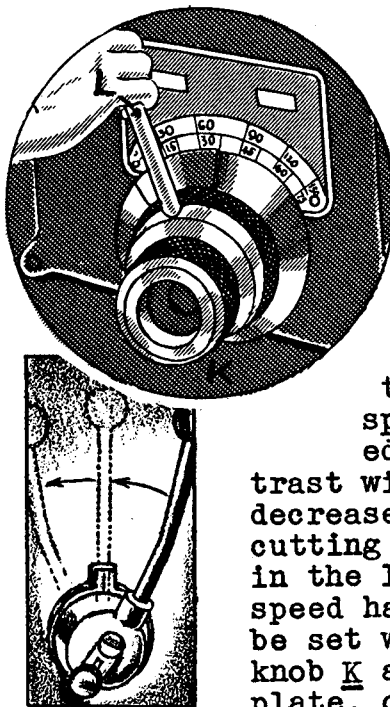

The controls provided on the hydraulic shaper shown on page 33 for regulating the speed of the ram, the length of the ram stroke, and the position of the stroke with relation to the cut, differ considerably from the controls provided for regulating similar ram movements on the crank shaper.

Instead of being specified as strokes per minute, the speed of the ram has been indicated as the cutting speed in feet per minute on the speed-index plate attached to the flow-control valve (page 42). Also, in contrast with the crank shaper whose cutting speed increases or decreases whenever the stroke is made longer or shorter, the cutting speed of the hydraulic shaper is unaffected by changes in the length of the stroke. Therefore, once the cutting speed has been determined in feet per minute, this speed may be set without recourse to calculations, by simply loosening knob K and then moving lever L to any number on the speed plate, or to any intermediate position thereon.

Furthermore, either the "High" or the "Low" series of speeds on the speed plate may be selected by shifting the starting lever to the position which brings either the word "High" or "Low" on its hub in registration with its reference mark. The functioning of the starting lever has been fully explained on page 42. Thus, instead of the usual eight speeds provided on a crank shaper, an infinite number of speeds within the limits prescribed on the speed plate become available on the hydraulic shaper.

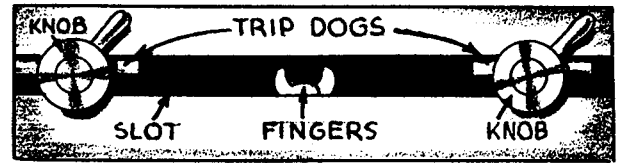

Both the length of the stroke and its correct placement over the work are controlled by the two knobs located over the slot in the ram. These knobs are actually clamping nuts screwed onto the upper ends of threaded studs which extend downward and terminate in flat rectangular members under the ram slot (Fig. 69).

These rectangular members are, in effect, trip dogs placed at opposite ends of the ram stroke and clamped in the desired position by means of the knurled knobs. The trip dogs alternately engage with fingers located one above the other on the upper end of a vertical shaft connected with the pilot valve. Each time one of the rectangular members (trip dogs) engages a finger, the shaft attached to the finger makes a partial rotation and actuates the pilot valve, causing it to reverse the direction of the ram movement in the manner explained on page 45.

Inasmuch as the knobs, together with the rectangular members to which they are connected by means of studs, can be moved in the ram slot, they may be spaced and located to suit any job whose length is within the capacity of the shaper.

HOW TO CONTROL MOVEMENT OF THE TOOL SLIDE

Movement of the tool slide, together with the cutting tool, is controlled by the handle attached to the down-feed screw located within the slide. The slide is lowered by rotating the handle in a clockwise direction, and raised by turning it in the opposite direction (Fig. 70).

The extent of its vertical and angular movement — about 7" on a 16-inch shaper — is limited by the length of the slide itself and by the length of the down-feed screw also. For convenience in making accurate adjustments of the slide and the tool, the feed screw has been fitted with a micrometer dial, graduated in thousandths of an inch. (Refer to page 91.)

A dial, similar in function, is also provided on the cross-feed screw and sometimes on the elevating shaft as well. Together they provide micrometer adjustment of both the tool and the work. When the dial is clamped in place, it

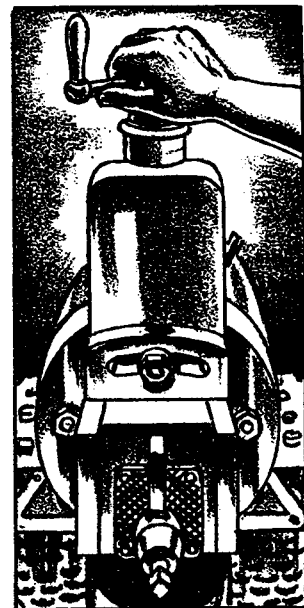

FIG. 70

becomes an integral part of the screw on which it is mounted and accurately measures movement of both the screw and the part of the machine which it is intended to move.

The number of graduations on the collar is directly related to the lead of the screw (the distance a screw advances in one revolution). For example, if the down-feed screw has five threads per inch, one revolution of the screw advances the tool slide $1/5$ of an inch or .200". If the circumference of the graduated collar is divided into two hundred equal spaces, then the distance between lines on the collar represents $1/200$ of a revolution or one one-thousandth of an inch (.001").

HOW TO TAKE UP BACK LASH

Whenever a graduated dial is used on the shaper for making accurate adjustments of the tool or the work, all "back lash" or "lost motion" must be taken out of the screw before the dial is set to a definite figure. Back lash in a screw is the lost motion existing between the threads of a screw and the threads in the nut through which the screw turns. Back lash is present in a small degree even in new machines, and to a greater extent in older machines as wear occurs.

For example, before using the micrometer dial for setting the tool for a certain cut, back lash must be taken out of the down-feed screw. One way to make certain that all back lash has been taken out is to give the handle about a half turn in a direction opposite the proposed adjustment before setting the tool to the surface from which the depth of cut is to be measured with the dial. (Refer to Fig. 71 A.)

For subsequent cuts in the same direction, back lash will be of no further consequence. When the movement of the tool is reversed, however, from a downward direction to an upward direction, the back lash must be taken up again, before the tool will move up when the screw is turned. (Refer to Fig. 71 B.)

The amount of back lash in the screw can be measured, also, when its direction is reversed, for at this time the screw makes a partial turn before the tool slide is moved in the opposite direction by the screw. This partial turn may be measured by noting the readings on the dial before reversing the screw, and again at the instant the tool slide moves in its reversed direction.

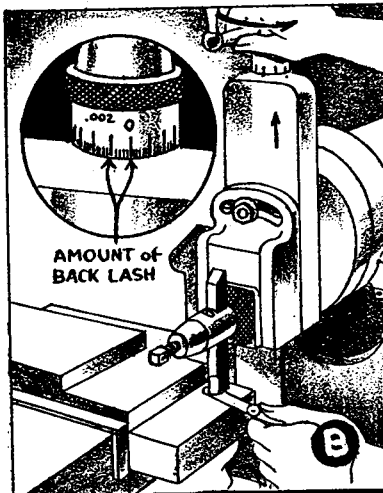
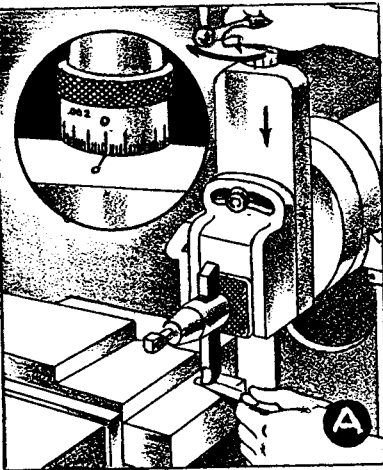

**TOOL DOES NOT
RAISE UNTIL
BACK LASH IS
TAKEN UP —**

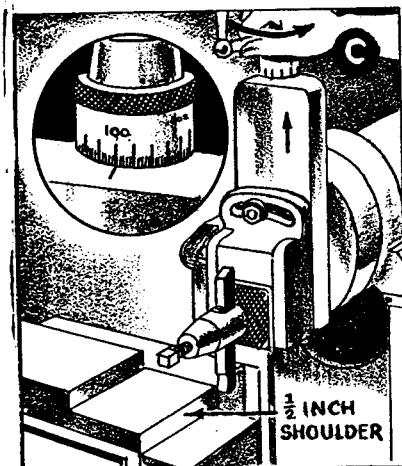

FIG. 71

HOW TO CARE FOR THE SHAPER AND ITS ACCESSORIES

Care of the shaper and its accessories requires the performance of certain tasks before the machine is set in motion, and the performance of others of equal importance after the job has been completed. These tasks pertain largely to maintaining the shaper in good working condition.

In addition, care of the shaper and its accessories requires the observance of certain precautions during the setting up of the job and the tool. Finally, the operator must adhere to certain accepted procedures during performance of the job, and avoid other procedures which are prone to cause damage to the machine and may involve the safety of the operator and his fellow workers.

A tradesman's standing among his fellow workers and their appraisal of his ability are determined, to a large extent, by the treatment he accords machines and tools with which he works.

An efficient worker operates machines with care. He also handles tools in a manner which will continue their usefulness over a long period, and he returns them to their proper places when the job is completed. He knows accuracy is impossible with tools damaged by rough usage and haphazard piling about the machine.

He disposes of chips before they become a hindrance to his work, and he judiciously lubricates his machine in a routine manner at such regular intervals as dictated by the speed of the machine and the type of work performed.

He assumes that other workmen, like himself, prefer to start a job with a clean machine and, therefore, he makes certain that it is clean and in good working order when he leaves it.

Every setup of the job and the machine includes the numbered steps below. Procedures recognized by skilled tradesmen as being helpful in turning out good work and in reducing machine wear and damage to a minimum, are recommended under each step.

1 LUBRICATING THE SHAPER

- a. Read the Description of the Oiling System beginning on page 29.
- b. Follow the instructions given in the section, How to Oil the Shaper (page 47), which apply to the type shaper in use.



2 MOUNTING THE WORK-HOLDING DEVICE



- a. Remove all burrs, chips, and dirt from the surface of the machine table in order to provide a flat, clean surface on which to place the work-holding device.
- b. Thoroughly clean the bottom of the vise or other work-holding device before it is placed on the machine table. This precaution will prevent pitting and scarring of the table and the bottom of the vise, an undesirable condition resulting from the presence of chips between these surfaces.
- c. Ask for help in lifting whenever it is necessary to place in position or to remove a heavy fixture or machine vise. Dropping it may damage both the machine and the holding device and, worse still, may cause personal injury.
- d. Place a washer under each nut used for clamping a vise, a fixture, or the work itself to the machine table. Make certain, however, that the nut has not been drawn down to the end of the thread on the bolt, for if this occurs, the part which it is intended to clamp will still be free to move, although the force applied to the nut would indicate that the part has been clamped securely to the table.

3 MOUNTING THE WORK

- a. Clamp all work in the shaper securely, using whichever method is most appropriate for holding the particular job. It is dangerous to have the work move even a small amount during the cut, but work which is forced out of the holding device by pressure of the cutting tool is almost certain to damage the shaper before the machine can be brought to a standstill.

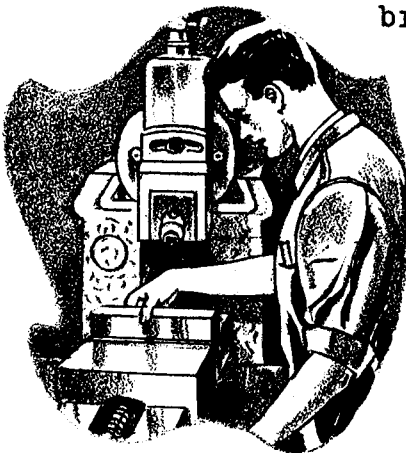

- b. Place a cardboard between the vise jaws and a rough casting and between the table and the casting if it is clamped to the table instead of in a vise or in a fixture. Cardboard will protect these machine surfaces from the irregularities which are usually present on unmachined castings.

CAUTION

Refrain from using a hammer on the handle of the shaper vise as an aid in tightening the

wise on the work. The handle is usually of a length which will allow the application of enough pressure to hold the work without the aid of a hammer. Besides, hammering is likely to set up burrs which will injure the operator's hands.

- c. Place all the work held in the vise as far down in the jaws as practicable without having the tool cut into the vise jaws. If a job is to be clamped to the machine table, keep it as low as possible. This procedure makes the setup rigid and reduces the vibration to a minimum during the cut.
- d. Use the shortest bolts possible for clamping work so as to avoid interference between the ram and the bolts. This applies especially to the bolts nearest to the ram.
- e. Avoid marring the machine table by using only wood, or metal blocking which has no burrs, for supporting the outer ends of clamps used to hold work to the table.
- f. Use parallels, and store them also, in a manner which will preclude their becoming damaged through falling on hard material, for this will raise a burr, and their use in this condition will result in inaccurate work. When a parallel becomes burred despite all precautions having been taken to prevent this condition, remove the burr with a flat, smooth file if the parallel is soft, or, if the parallel has been hardened, use an oil stone for this purpose.

4

MOUNTING THE TOOL

- a. Clamp the tool holder in the tool post with as little overhang as practicable. This eliminates the unnecessary strain which is placed on the tool head when a cut is made with the tool holder extending below the tool block farther than is required.
- b. Place the tool holder in a vertical position so that if it should be forced over by the pressure of the cut, the tool will swing in an arc away from the work, instead of into the work as would be the case if the tool holder were set toward the cut.
- c. Clamp the tool holder securely in the tool post to prevent its working loose during the cut.
- d. Use only sharp cutting tools, for dull tools require considerable more power to remove a given amount of metal than do sharp tools. Furthermore, a dull tool creates much more heat than does a sharp



tool, and, moreover, produces an inferior finish on the work.

- e. Clamp the cutting tool securely in its holder and as short as practicable. If applied, these two recommendations will prevent tool breakage and its attendant hazards to the operator and the machine. Furthermore, clamping the tool as suggested conforms to the practice of keeping the setup rigid.
- f. Make certain that the clapper block is functioning correctly: (1) that it lifts slightly on the return stroke of the ram, and (2) that it assumes its position against the back of the clapper box immediately under pressure of the cut.
- g. Adjust the tool holder and the tool only when the machine is at a standstill. These adjustments become extremely hazardous if made when the shaper is in motion.

5

ADJUSTING THE WORK AND THE TOOL

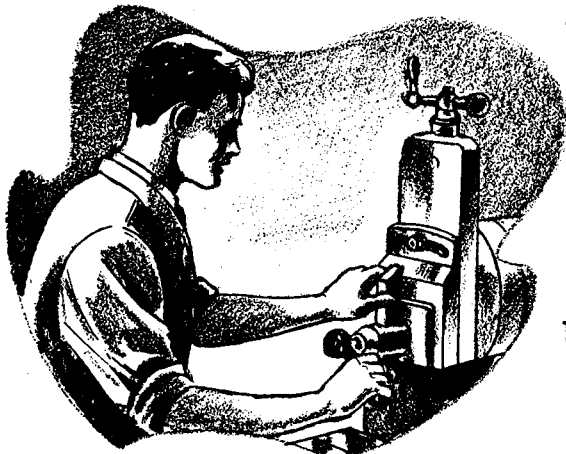

- a. Before turning a handcrank, shifting a lever, or pushing a control button, ascertain very definitely just what action will result when each control is manipulated. Manipulating any part of the shaper without knowing what motion will occur, in what direction and how fast, may result in serious damage to the machine.
- b. Thoroughly clean, and then oil, the flat bearing surfaces on the cross rail used to guide the table horizontally. Give the same care to the bearing surfaces on the front of the column, used to guide the table vertically. This care should be accorded these surfaces each time the table is moved to any extent.
- c. Remove all tools and accessories from the base of the machine to avoid jamming when the cross rail is lowered. Tools placed on other parts of the shaper and no longer needed for the job should also be removed. This is especially important if these tools are likely to become dislodged through vibration and thus interfere with the movement of the parts being fed automatically. Considerable damage to the feed mechanism usually results if movement of a part is forcibly stopped while the shaper is in operation and the automatic feed is still engaged.
- d. Previous to making adjustments of such parts as the cross rail, loosen the clamps which lock these parts rigidly in place during the cut. It is equally important that these clamps be

tightened after the adjustment has been made and that all other parts not used to feed the work or the tool be clamped securely also.

- e. To assure a more rigid machine setup, adjust the table vertically so that the space between the work and the bottom of the ram is no greater than the safety of the operator requires. A space of approximately two inches is considered sufficient for this purpose.

Whenever the distance between the ram and the work is increased appreciably, the tool slide must be extended beyond the tool head a correspondingly greater distance. In this extended position, the tool slide is not well supported, and, as a result of this lack of support, is likely to be broken if the tool should get caught in the cut or if the slide should strike the column at the end of the return stroke.

- f. Avoid gear clashing when the speed is being set. Make all speed changes with the clutch disengaged.
- g. Whenever the construction of the shaper permits, pull the belt or turn the hand wheel to give the ram one complete stroke by hand, before turning on the power. Since this is impossible on many shapers equipped with individual motor drive, the clutch should be engaged cautiously while the ram makes a complete stroke. This procedure is recommended to permit detection of any interference between the ram and the work.
- h. Before engaging the rapid power traverse, make certain there will be no interference between the tool and the work. Also, in order to avoid jamming these parts, ascertain whether or not the table can be fed over the required distance before reaching the limit of its travel on the cross rail.

6 TAKING THE CUT

- a. Set a cutting speed which is commensurate with the length of stroke and at the same time takes into consideration the material being cut and the cutting material in the tool.
- b. Set the tool so that it clears (passes over without cutting) the highest part of the job before engaging the clutch. After the machine has been set in motion, feed the tool down toward the work carefully.
- c. Lock the tool slide in place after the depth of cut has been established so as to keep it from moving during the cut.

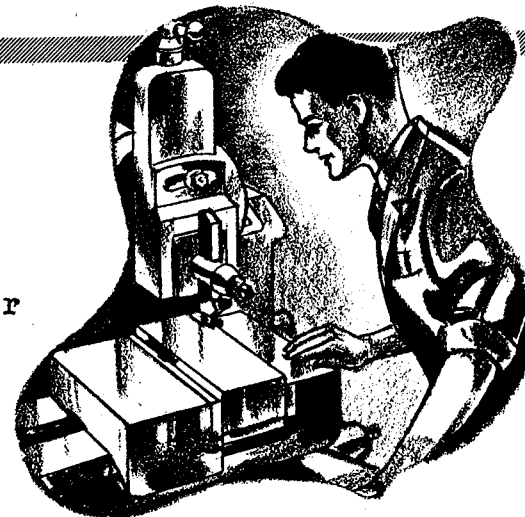

- d. Before engaging the automatic feed, ascertain the rate of feed for which the machine has been adjusted.
- e. Whenever the automatic feed operates at the beginning of the cutting stroke, instead of preferably during the return stroke, adjust the length and the position of the stroke so that the tool will run beyond the back end of the work a somewhat greater distance than usual. This will allow the feeding of the table to be completed before the tool engages the cut. The feed mechanism should not be forced to feed the work after the tool begins to cut, for it was not designed to withstand the heavy pressure required to force the tool into the metal.
- f. Feed the work to the tool slowly by hand, and then, if the cut is of the desired depth, engage the automatic feed.
- g. Remain at the machine while the cut is in progress in order to maintain control thereof at all times.
- h. Brush chips from the work in a direction which will prevent their entering the working parts of the shaper.
- i. After completing angular shaping, set the tool head back to the vertical position and tighten it in place. This is a precautionary measure recommended to prevent the tool head from striking the column during the return stroke, a hazardous condition which develops when the stroke is lengthened and the head is left in the angular position.

7

DISASSEMBLING THE SETUP

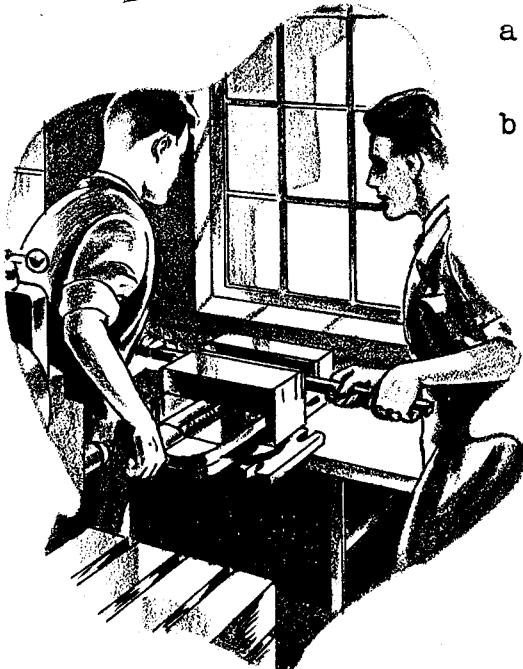

- a. Clean the work-holding device of all chips and oil.
- b. Remove any special holding device or fixture from the machine and return it to its proper storage space.

NOTE: The vise is usually left on the machine table and bolted securely in place. Leaving the vise in place with the bolts loose may result in serious injury, for the vise is sure to move when work is tightened therein.

- c. Return all tool holders not usually used on the shaper to the tool crib, or to the storage cabinet if one is provided.
- d. Brush all chips from the machine;

then wipe it with waste.

- e. Return all straps and bolts to their proper places in a clean condition. Assemble the bolts, the nuts, and the washers.
- f. Carefully return parallels to their storage space to avoid burring.

8 MAINTAINING THE SHAPER IN A GOOD OPERATING CONDITION

Under this heading have been listed some of the measures which should be observed for the correct functioning of the shaper and its driving mechanism. Because of his daily association with the shaper, the operator should detect immediately conditions about the machine which contribute to inefficient operation and to inaccurate performance. Since the operator's regular duties usually do not include correction of these faulty conditions, it is his duty to report them to the individual responsible for maintaining the machine in proper adjustment and in good repair. The following are among such measures:

- a. Adjust the tension on the belt when necessary in order to prevent excessive slippage on the pulley and thus assure maximum power when it is needed.
- b. Make adjustments on the machine required because of wear, and necessary for the production of accurate work.
- c. Give timely service to electric motors and their controls in order to forestall their breakdown.

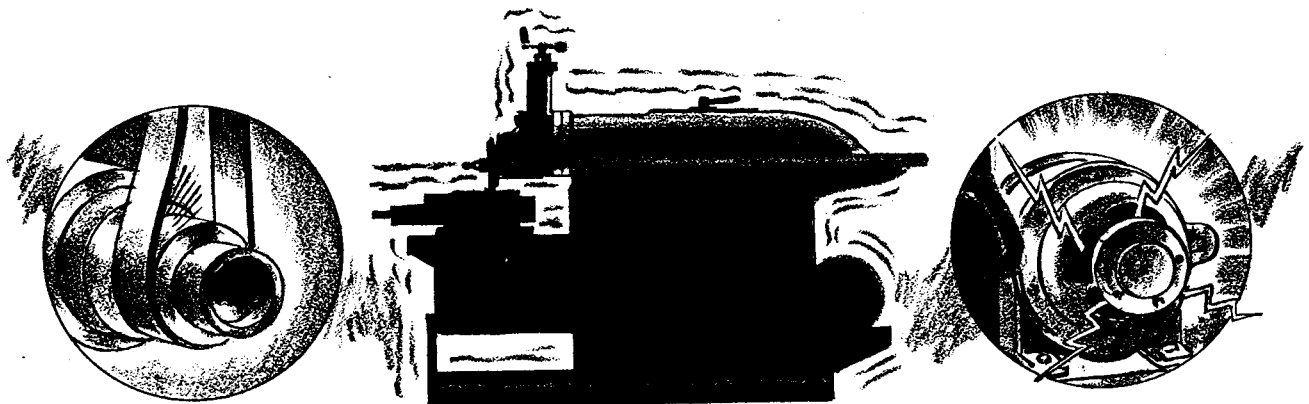

HOW TO ADJUST THE SHAPER

Unit 1-P52(A) Part III Pages 75 to 96

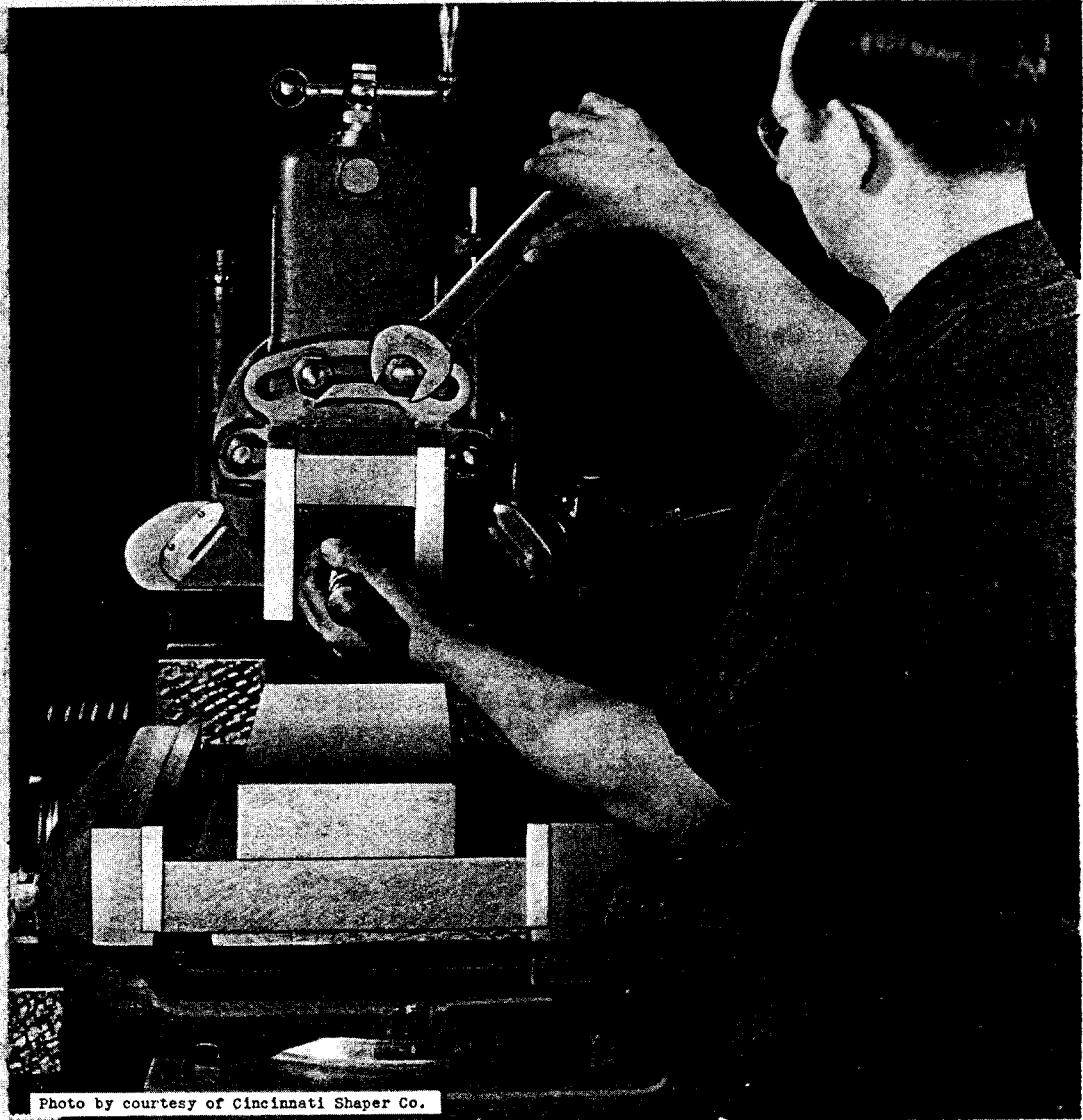
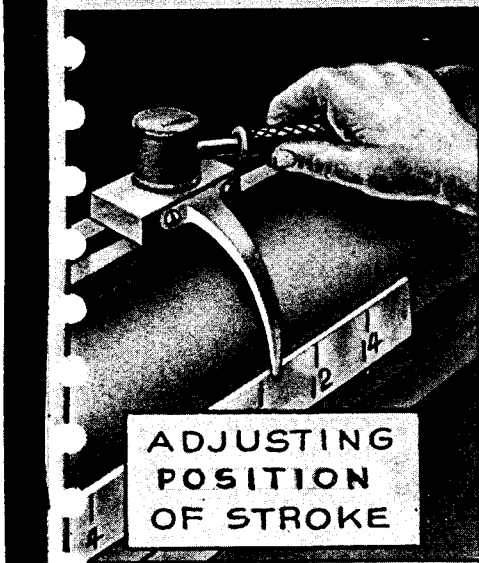
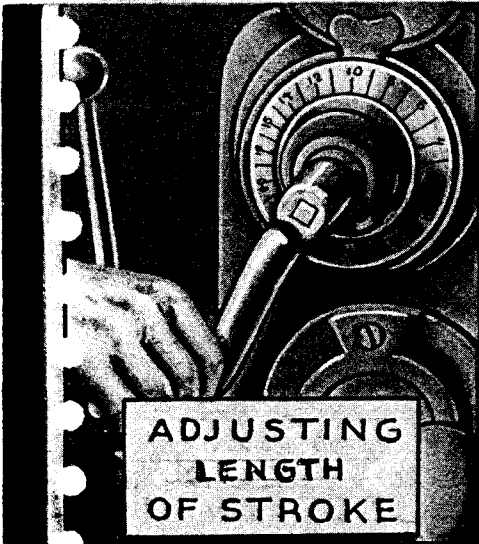

UNIVERSITY OF THE STATE OF NEW YORK
STATE EDUCATION DEPARTMENT
BUREAU OF INDUSTRIAL AND TECHNICAL EDUCATION

HOW TO ADJUST THE SHAPER

OBJECTIVES OF UNIT

1. To point out the machine adjustments which should be made prior to actual machining operations.
2. To show how to make these adjustments on various parts of both the crank shaper and the hydraulic shaper.
3. To explain how job specifications influence machine adjustments.

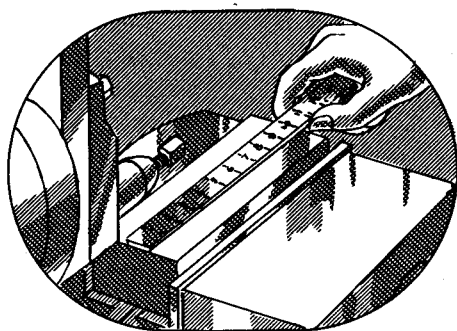

INTRODUCTORY INFORMATION

Certain definite machine adjustments must be made, or at least must be given consideration, for every job performed in the shaper; for if the machine is to be set up rigidly and if the work is to be performed without an undue amount of lost motion and lost time, the machine must be adjusted to meet the requirements of the job.

Since two jobs are seldom exactly alike in all respects, several machine adjustments may be required in order to have the machine operate efficiently. For example, considerable variation in the height of the work requires that the table be adjusted vertically for rigidity in the setup. For economy of time, the length of stroke should be adjusted to the minimum required for each job, and for the same reason the speed of the shaper should very closely approach that recommended for machining the material in the job with the particular cutting medium in use.

Furthermore, the type of cut, whether rough or finish, influences the amount of feed used and, therefore, requires an adjustment of the feed mechanism whenever it is necessary to change from one type of cut to another.

Most of these adjustments should be made preferably after the job has been located in the machine vise or in whichever other holding device is used for gripping the work. Furthermore, they should be made in the sequence suggested here, and, *most important of all*, for the safety of both the operator and the machine, should be made prior to starting.

Whenever the directions for making an adjustment on the hydraulic shaper differ from those given for making a like adjustment on

the crank shaper, a set of directions has been written for adjusting both types of shapers.

The directions for adjusting the hydraulic shaper, however, have been placed in a separate section beginning on page 92.

TOOLS AND EQUIPMENT

Shaper
Scale

Wrenches of correct size
Oil can for machine oil

Tool holder
Tool bit

PROCEDURE

HOW TO ADJUST THE CROSS RAIL

1. Wipe all chips and dirt from the front faces of the column, for when the vertical position of the table must be changed, the cross rail is moved up or down on these bearing surfaces.
2. Apply a small quantity of oil to the clean bearing surfaces of the column, distributing the oil evenly with the fingers.
3. Loosen the table support clamps **C** which fasten this support (if one is used) to the table. (Refer to page 11.)
4. Loosen the clamping nuts, or the clamping levers — on both sides of the column — which lock the cross rail rigidly to the column. In some makes of shapers the clamps for both sides may be manipulated from the operator's side. (Refer to page 8.)

NOTE: Do not loosen the other strap bolts as they are adjusted to hold the rail "slideably" to the column.

5. Avoid possible damage to the machine from tools and work pieces placed on the base of the shaper by removing them before changing the position of the rail.
6. Make certain that chips and dust do not become lodged between the column and the cross rail. Foreign material between their surfaces will cause misalignment of these parts and also may cause scoring of their faces, if these parts are moved when chips are present.

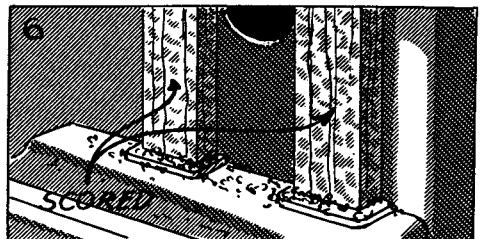
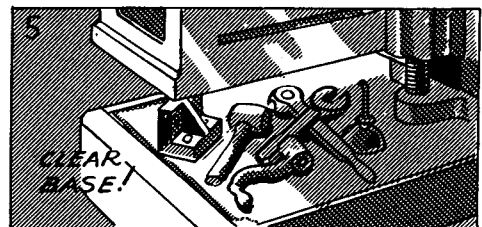
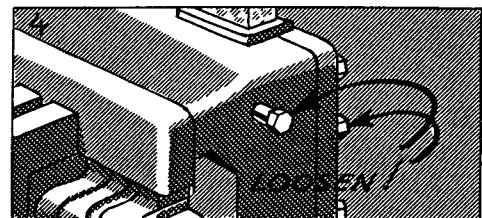
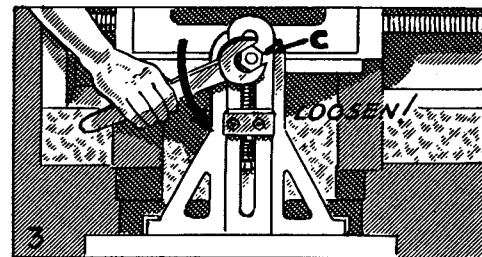
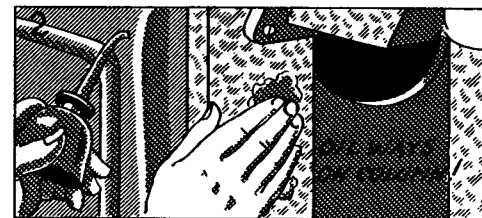

7. Place a crank on shaft S which is connected with the elevating screw through bevel gears within the rail.

8. Turn this crank in a clockwise direction to lower the table and vice versa to raise the table. In either case, whether the table is raised or lowered, the underside of the ram should clear the work by no less than two inches for the safety of the operator.

9. Tighten the clamps used for locking both sides of the cross rail rigidly in place on the column.

10. See that the slide for the table support is clean; apply a few drops of oil thereto; and then tighten the table support clamps, making sure that the support rests on its sliding surface.

NOTE: The rail clamps always should be tightened before the table support is adjusted, for with the rail clamps loose, the table sags somewhat because of its weight. Thus, if the support is adjusted and clamped with the rail clamps loose, their subsequent tightening will raise the support slightly from its slide and result in table deflection under pressure of the cut.

HOW TO ADJUST THE TABLE HORIZONTALLY

1. Examine the bearing surfaces of the cross rail over which the saddle, together with the table, moves. If these surfaces are found to lack oil, or, if the oil is found to be dirty and laden with grit, proceed according to the directions given in No. 12 on page 53.

NOTE: Considerable pressure is exerted on the faces of the cross rail because of the overhang of the table. In addition,

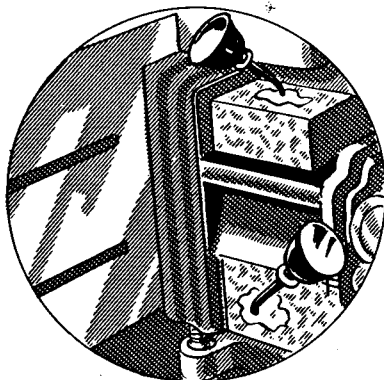
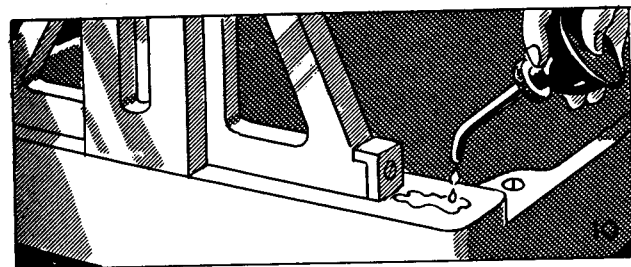
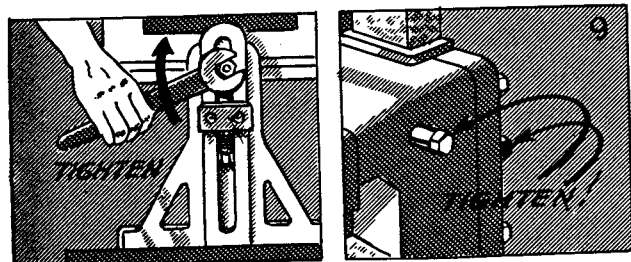
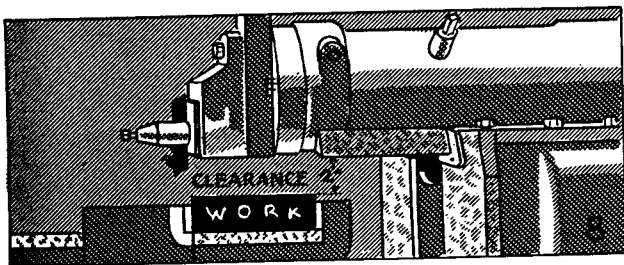
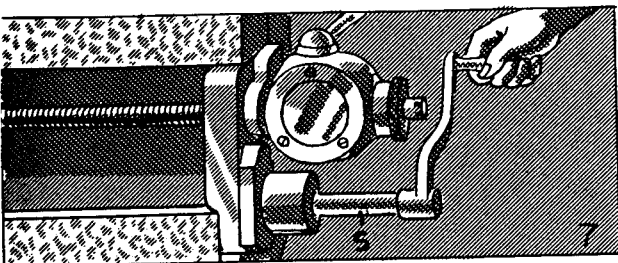

these faces are continually exposed to dust and chips. As a result of these conditions the cross rail will wear out of shape rapidly and will make accurate work difficult, unless the bearing surfaces are kept clean and well oiled at all times. On modern shapers, felt wipers impregnated with oil help somewhat to clean the surface and to apply oil.

2. Remove the handcrank from the elevating shaft and place it on the end of the cross-feed screw.

NOTE: In a machine equipped with rapid power traverse, the cross-feed screw, instead of being squared on the end to receive the crank, usually has clutch teeth of one form or another. This design eliminates the hazard of a rapidly revolving crank, for although it remains on the screw, the crank does not revolve with it when the automatic feed is applied. For hand feeding, the crank is pushed forward, meshing the teeth on the crank with those on the screw which are held out of engagement by a spring.

3. Make certain that the feed knob or the feed lever, whichever construction is used, is in neutral, a position in which the automatic feed is disengaged.
4. Rotate the crank on the cross-feed screw in a clockwise direction to move the table away from the operator and vice versa to move the table toward the operator.
5. Move the table over until one edge of the surface to be planed is approximately central with the ram.

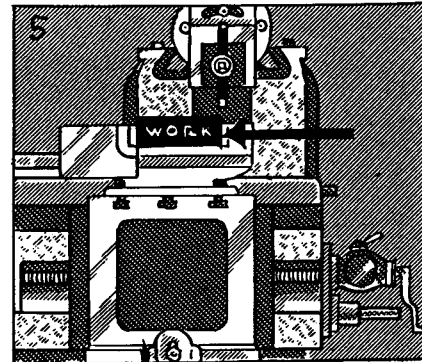
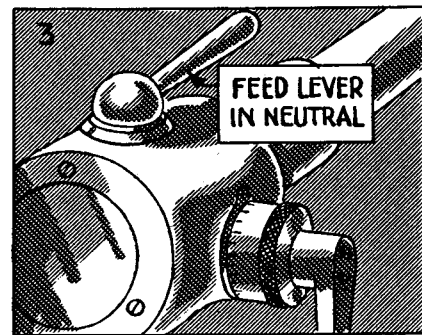
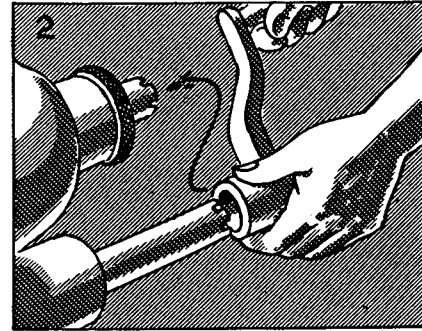

HOW TO ADJUST THE STROKE ON SHAPERS WITH A SCALE ADJACENT TO THE RAM

1. To determine the length of stroke for which the shaper must be adjusted, measure the length of the surface which is to be planed; then add one inch to this dimension to provide for clearance of the cutting tool at both ends of the job.
2. Before adjusting the stroke, pull the belt by hand, or turn the handwheel if the shaper is motor-driven, and stop when the

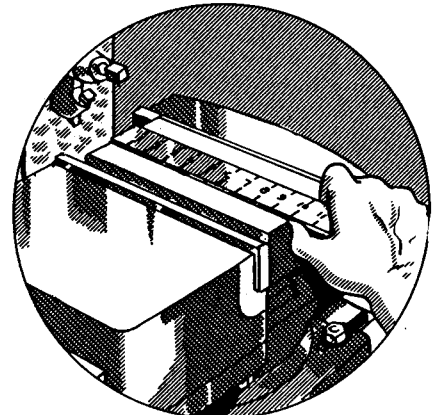

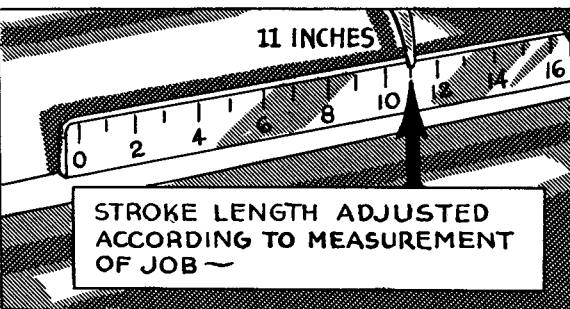
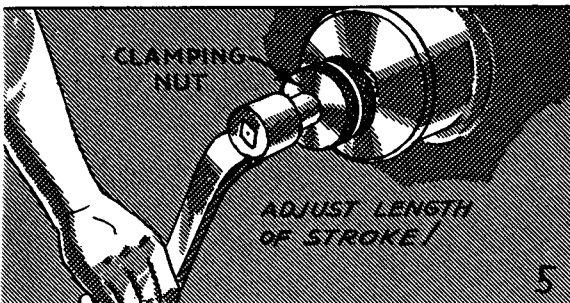
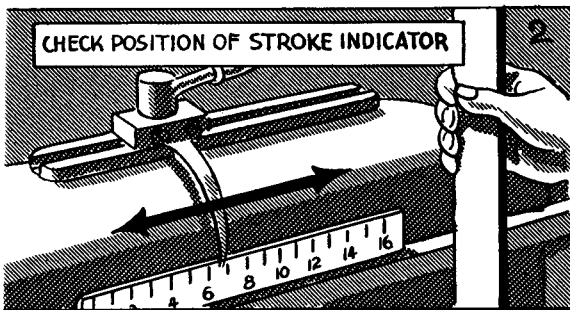

stroke indicator, moving with the ram, ceases to move along the stationary scale. The highest number reached indicates the present stroke-length and determines whether or not an adjustment is needed.

3. Loosen the clamping nut on the outer end of the stroke-adjusting shaft. (Refer to page 20.)
4. Place the proper crank on the square end of the stroke-adjusting shaft.
5. Turn the crank in one direction or another, depending on whether the stroke is to be made shorter or longer, until the stroke indicator is over the number on the stationary scale which corresponds with the length of ram stroke required. This number should be the one derived in step No. 1 above. (Refer to page 20.)
6. Tighten the clamping nut on the stroke-adjusting shaft, so that the length of ram stroke will not change during the operation of the shaper.
7. Remove the crank from the stroke-adjusting shaft.

HOW TO ADJUST THE STROKE ON A SHAPER WITH A DIRECT-READING STROKE INDICATOR

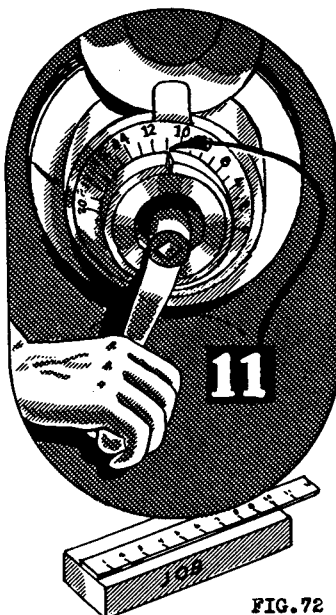

FIG. 72

1. Measure the length of the surface which is to be planed and add one inch to this measurement in order that the ram stroke will permit the tool to travel beyond the back and front ends of the work.
2. Place the proper crank on the square end of the stroke-adjusting shaft (Fig. 72).
3. Turn the crank, together with the dial, until the number coinciding with the indicator corresponds with the length of stroke in inches as derived in step No. 1 above. (Refer to page 21.)

4. Remove the crank from the stroke-adjusting shaft.

NOTE: The two actions, unlocking the stroke-adjusting shaft before setting the ram stroke and again locking it after the setting has been made, occur co-incidentally with the insertion and withdrawal of the crank. (Refer to page 21.)

FOR ADJUSTMENT OF
THE STROKE ON THE
HYDRAULIC SHAPER,
REFER TO PAGE 92.

HOW TO ADJUST THE POSITION OF THE RAM

1. Place the tool holder, together with the cutting tool, in the tool post and clamp it in the approximate position it will occupy during the cutting process.
2. To ascertain whether or not the stroke will cover the work, stop the ram, after moving it to its extreme forward position by pulling the belt, turning the handwheel, or using whichever other means is appropriate for the shaper being used.
3. Loosen the clamping block by turning the binding lever L in a counter-clockwise direction.
4. Place a crank on the square end of the ram-adjusting shaft S; then adjust the ram until the cutting tool extends about one-fourth inch beyond the front edge of the surface to be planed.
5. Remove the crank and turn the binding lever clockwise, clamping the ram securely in position.
6. Pull the belt by hand, or use whichever other means is most appropriate to the shaper in use, and move the ram to the extreme end of its return stroke. When the ram occupies this position, the cutting tool should extend about one-half inch beyond the work. If, however, the feed operates at the beginning of the stroke, instead of during the return stroke, slightly more clearance and a longer stroke must be provided.

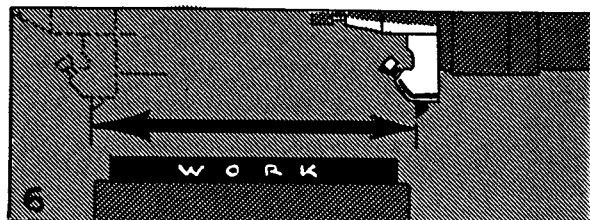
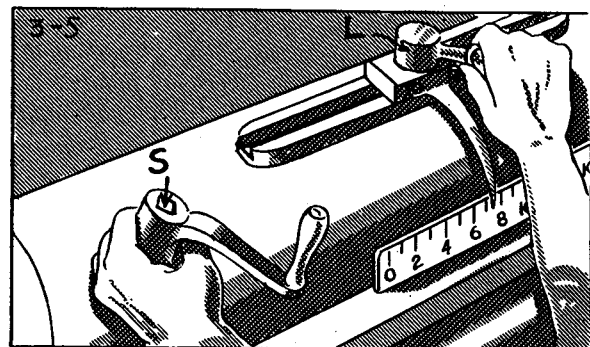
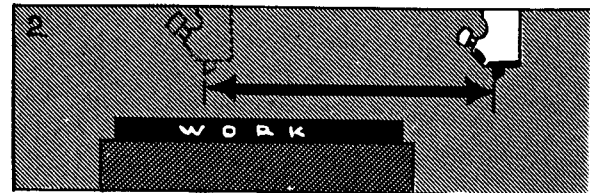
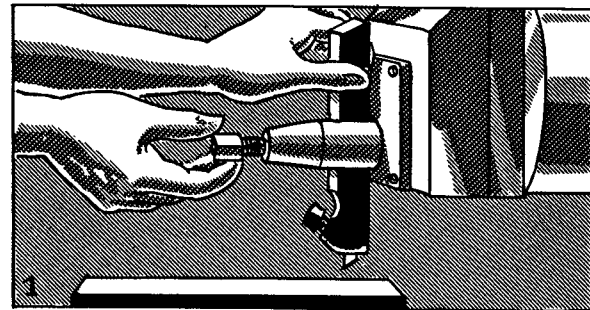

HOW TO ADJUST THE SPEED OF THE RAM

Eight different ram speeds, indicated as strokes per minute, are usually provided on the shaper. The speeds are available in two series of four each: a direct series for the faster speeds and shorter ram strokes, and a series through the back gears for the slower speeds and longer ram strokes. Thus, two speeds are possible for each position of the gear-shift lever on the shaper with a geared transmission, and also for each step of the cone pulley on a belt-driven shaper — one speed with the back gears "in" and another with the back gears "out." (Refer to page 21.)

It is desirable, usually, to adjust the speed of the shaper, that is, to regulate the number of strokes per minute, so that the cutting speed of the tool in feet per minute closely approximates the established rate at which each different material can be machined most economically. In other words, for cutting similar material, the shaper must make twice as many strokes for a cut 6" long as it does for a cut 12" long, if the cutting speed is to be at the same rate for both cuts.

Apparently then, if a uniform cutting speed is to be maintained, the number of ram strokes per minute must be reduced when the stroke is lengthened, and must be increased when the stroke is shortened.

Most modern shapers have a speed chart attached. From this chart the operator can determine, without calculations, how many strokes per minute of a given length the ram must make for the tool to attain a desired cutting speed.

In the operation of a shaper which is not equipped with this convenient speed chart, it becomes necessary to use calculations similar to those in Unit 1-T53(D) beginning on page 293, to determine the correct ram speed required for various stroke lengths and for various materials.

Since each make of shaper employs a somewhat different method for setting the speed of the ram, it will be impossible to explain all of them. However, directions have been given for adjusting the ram speed on several makes. Familiarity with the methods explained here, together with a study of a particular one which differs from these, should enable the operator to set the speed on any shaper without difficulty.



HOW TO USE A SPEED CHART TO ADJUST THE
SPEED ON A CONE-DRIVEN SHAPER

1. Pull the belt until the stroke indicator reaches the largest number on the stroke-index plate in order to determine the length of stroke for which the ram has been adjusted.
2. Refer to plate P above the cone pulley. From the numbers appearing on this plate, choose the one which most nearly corresponds with the length of the stroke. The location of this number on plate P determines the position of the belt.

NOTE: For strokes of an odd number of inches in length, such as 7, 9, etc., which do not appear on plate P, the position of the belt should be on the next larger or smaller step of the pulley, depending on whether or not the material being cut can be machined at a cutting speed that is higher or lower than average.

3. Remove the belt from its step on the lower cone pulley, pulling down on one side of the belt as well as out.
4. Shift the belt to the desired step on the upper cone pulley, then run the belt onto the corresponding step on the lower cone pulley.

CAUTION Do not start the shaper when it is necessary to shift the belt, for unlike most other cone-driven machines, the outer end of the pulley on the shaper is frequently unsupported, and there is nothing to prevent the belt from leaving the pulley entirely. A belt moving unrestrictedly may cause serious personal injury or may cause damage to the machine.

5. Observe in which column on plate P the number corresponding to the stroke length appears, and note the direction in which the arrow at the head of this column points. (Refer to Fig. 73.)
6. Move the back-gear lever L in the direction indicated by the arrow at the head of the column in which the stroke length appears; move it toward the column for strokes eight inches or less in length, and out from the column for strokes from ten inches to sixteen inches in length.

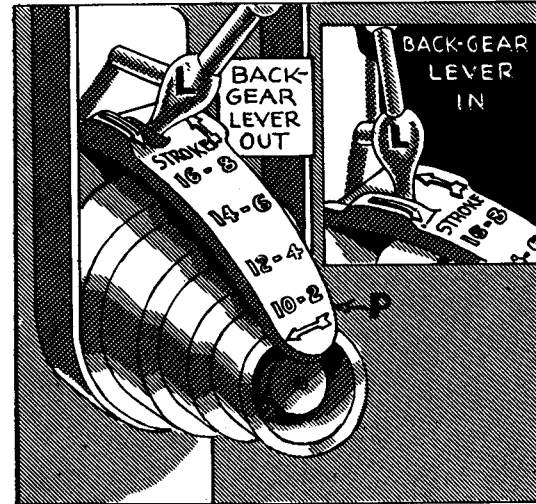
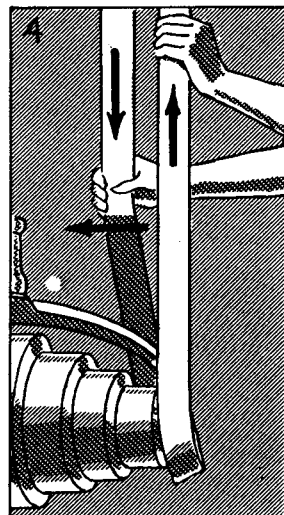
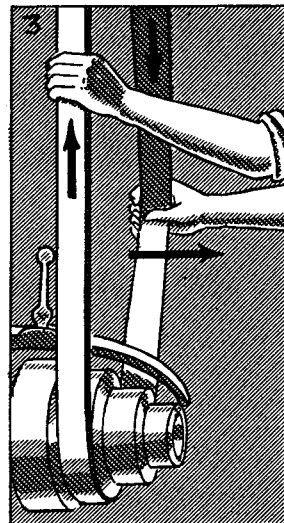
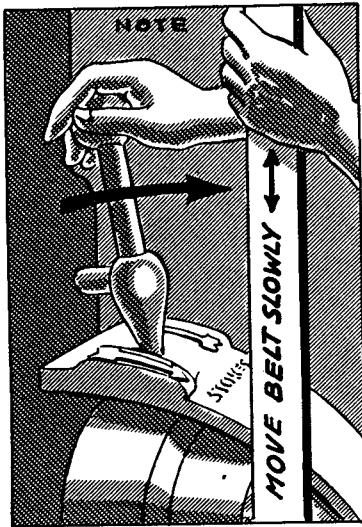

FIG. 73





NOTE: If, as occasionally happens, the teeth on the back gears are in such a relative position that they cannot be engaged readily, do not use force, but pull the belt slowly to change this relationship, and then the gears will slide into mesh easily.

7. Close the door on the belt guard when the speed setting has been completed.

NOTE: When the foregoing instructions have been followed implicitly, the ram will make the number of cutting strokes per minute of the length indicated, and this will result in a cutting speed in feet per minute which is approximately correct.

HOW TO ADJUST THE SPEED ON CONE-DRIVEN SHAPERS WITHOUT A SPEED CHART

Many cone-driven shapers lack speed charts and plates such as are provided on the modern shaper to help the operator determine the correct cutting speed. The operator of a shaper of this type either must calculate the speed, using as a basis the figures representing such factors as the length of stroke, etc., or he must depend upon his own judgment which, if it is reliable, gives consideration to the same factors used when calculations are made, but with experience as the basis instead of figures.

If the shaper has the usual four-step cone pulley and back gears such as shown in Fig. 73, but without plate P, some general rules may be formulated to assure the shaper's being operated at a safe and approximately correct speed. Minor increases and decreases can then be made from the approximate speed when differences in materials and unusual cutting conditions warrant such changes.

Proceed as follows to determine which step of the cone pulley to use for machining work requiring any stroke length within the capacity of the shaper.

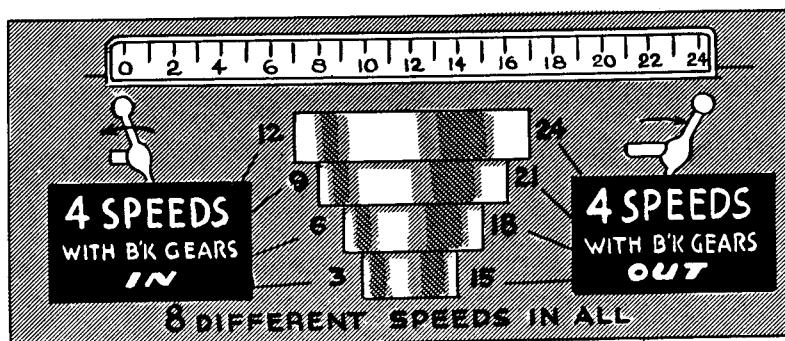

FIG. 74

1. Divide the maximum stroke length given on the index plate by the number of different speeds available on the shaper (Fig. 74).
2. Let the result of the division be the stroke-length in inches for which the smallest step on the cone

pulley will be used in direct speed (without back gears).

3. Increase by the amount derived in step No. 1 above, the length of stroke for which each succeeding, and larger, step of the pulley will be used.
4. Continue to increase by the same amount, the stroke-length for which each step of the pulley is to be used in the back-gear series of speeds, again beginning with the smaller step of the cone pulley.

A formula for these calculations could be written and used as follows:

$$I = \frac{A}{N}$$

in which

I = maximum stroke-length to be used with the small pulley;
I = amount of increased stroke-length for larger pulleys;
A = maximum stroke-length for which the shaper can be used;
N = number of different speeds available on the shaper.

Proceed as follows, to make a speed chart for a 24-inch back-gear shaper having a four-step pulley:

FORMULA: $I = \frac{A}{N}$, or, by substitution, $I = \frac{24''}{8} = 3''$.

Thus, the smallest step is used for ram strokes not exceeding three inches in length. The second and succeeding steps are used for strokes six inches, nine inches, and twelve inches in length, respectively. If this procedure is carried through, the series of back-gear speeds will begin with fifteen inches for the small step and continue to eighteen inches, twenty-one inches, and twenty-four inches for the progressively larger steps. The chart in Fig. 75 shows how the numbers should be arranged for a 24-inch shaper with eight speeds.

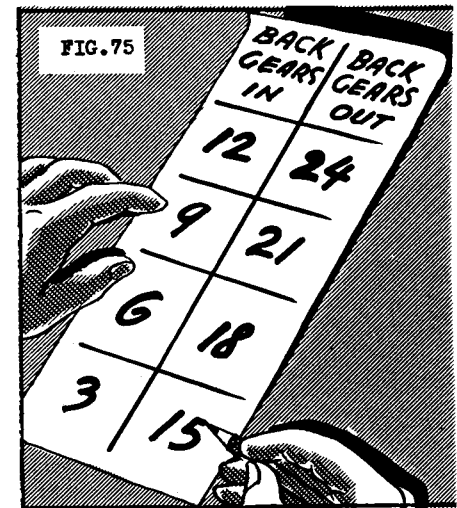

HOW TO ADJUST THE SPEED OF THE RAM ON A GEAR-DRIVEN SHAPER

To adjust the ram speed on a gear-driven shaper, follow the instructions given in the operator's manual supplied by the manufacturer, if it is available, for this contains specific directions on how to proceed. In the absence of a manual, the careful operator proceeds cautiously when adjusting the speed on a shaper which he has not previously operated. He examines the speed-adjusting mechanism thoroughly to determine wherein it resembles one with which he is familiar. This investigation will disclose familiar parts

which, in turn, will lead to a prompt understanding of the remainder of the mechanism.

Directions for adjusting the speed (number of strokes per minute) on several makes of shapers will be presented herewith in order to give the student an idea of some of the different ways in which this is accomplished.

Proceed as directed to adjust the speed on a Hendey Shaper.

1. Examine the speed plate, and observe that the factors required to determine the speed of the shaper have been included on it, notably:
 - a. the Length of Stroke in Inches, arranged in a vertical column on the left side of the plate,
 - b. the number of Strokes per Minute, represented by the figures in the upper row, and divided into two series of speeds — one series attainable with the Back Gears In, and the other with the Back Gears Out,
 - c. the Approximate Cutting Speeds in Feet Per Minute which result from the various combinations of stroke lengths and ram speeds.

2. Observe the numbers on the stroke plate, and note that they correspond with those in the upper horizontal row of the speed plate.

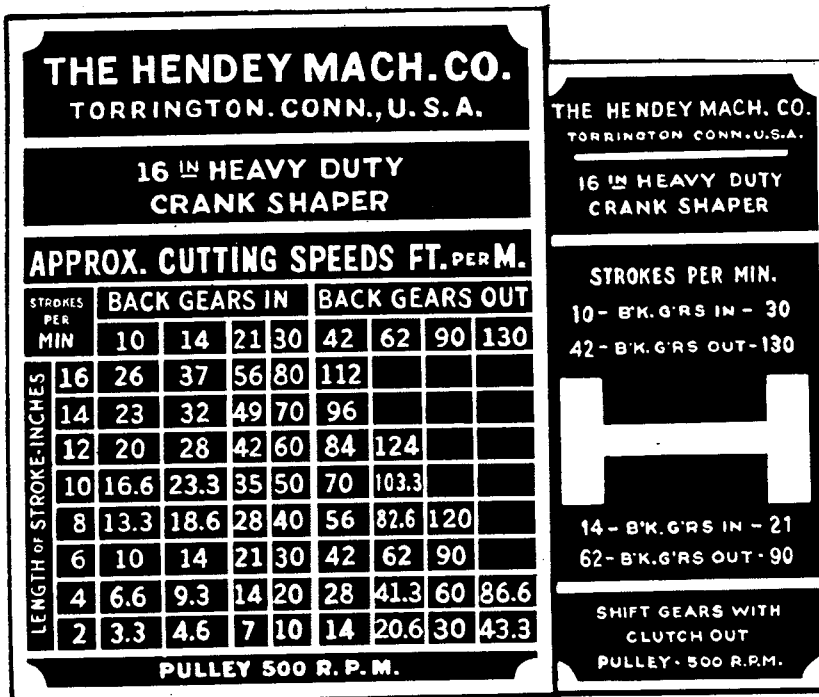

3. Determine the cutting speed in feet per minute at which the kind of material in the job should be machined. (Refer to the table on page 308.)

4. Consult the stroke-index dial and ascertain therefrom the length of the stroke for which the ram has been adjusted (Fig. 72).

5. In the first column on the left side of the speed plate, locate the number which corresponds with the length of the ram stroke as indicated on the stroke-index dial.

FIG. 76

6. In one of the vertical rows to the right of this number, locate the figure corresponding with that of the cutting speed selected in step No. 3.
7. Read the figure appearing at the top of this column; this represents the number of strokes per minute for the ram.
8. Observe the precautions which appear on the stroke plate regarding the shifting of the gears.
9. Select from the numbers on the stroke plate the one which most nearly approximates the number of strokes per minute as noted in step No. 7.
10. Move lever L into the slot, or place it in the position opposite which this number appears. (Refer to Fig. 78.)
11. Shift the back-gear lever B to its position marked "In" (for slower speeds) if the number of strokes per minute for which the shaper is to be adjusted appears in the left section of the speed chart. Shift the lever to the position marked "Out" if the number appears in the right section. The position which the back-gear lever should occupy during various speeds is indicated on the stroke chart also.

For example, to adjust the speed (number of strokes per minute) for taking a roughing cut on a cast-iron job requiring a 12-inch ram stroke, proceed in the following order. (Refer to Fig. 77.)

1. On the chart of allowable cutting speeds, page 308, find the cutting speed in feet per minute for a roughing cut on cast iron. The speed recommended is 60 feet per minute.
2. Find number 12, which is the length of stroke required, in the first column on the left side of the speed chart.
3. Move to the right in the row opposite number 12 and stop at number 60, which represents the cutting speed in feet per minute as determined in step No. 1 above.
4. Move up in the column above number 60 to number 30 which appears at the top and indicates the number of ram strokes per minute.
5. Shift lever L to the posi-

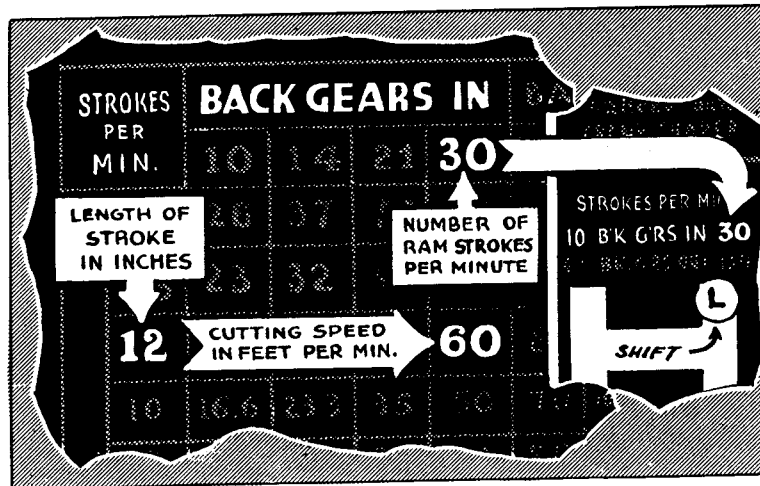
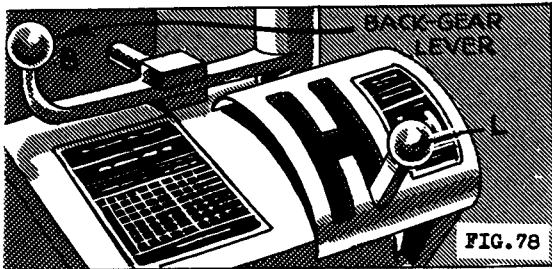

FIG. 77



tion under number 30 on the stroke chart.

6. Shift back-gear lever B to the position marked "In", as noted on both charts for a ram speed of 30 strokes per minute.

Proceed as directed to adjust the speed of a Cincinnati Shaper.

1. Determine the cutting speed in feet per minute which is recommended for shaping the kind of material in the job. (Refer to the table of Allowable Cutting Speeds on page 308.)
2. Ascertain from the stroke-index dial the length of stroke for which the shaper has been adjusted. (Refer to Fig. 72.)

NOTE: The cutting speeds which result from various combinations of stroke lengths and ram speeds — two factors which determine the cutting speed of the shaper tool — are frequently supplied on a speed chart attached to the shaper, as shown in Fig. 76. This manufacturer, however, supplies a table of cutting speeds in the operator's manual instead. This table has been reproduced here for use when the speed of the shaper is being adjusted. (Refer to Fig. 79.)

3. In the upper row of the table, locate the number which corresponds with the length of the ram stroke.
4. In the column below this number, find the figure which most nearly corresponds with that of the cutting speed in feet per minute, as determined in step No. 1.
5. Move to the extreme left column in the same row in which the cutting speed has been located. The number appearing at this point represents the strokes per minute for which the shaper is to be adjusted.
6. Select from the numbers on the stroke plate, the one which corresponds exactly with the number of strokes per minute as noted in step No. 5.

CAUTION

Do not shift gears when the clutch has been engaged.

7. By means of lever L, shift the speed indicator to the slot adjacent to the selected number.
8. Shift back-gear lever B to position A or B, the choice depending upon which of these letters precedes the speed selected in step No. 5. (Refer to page 293.)

Taken from Operator's Manual, Cincinnati Shaper Co.

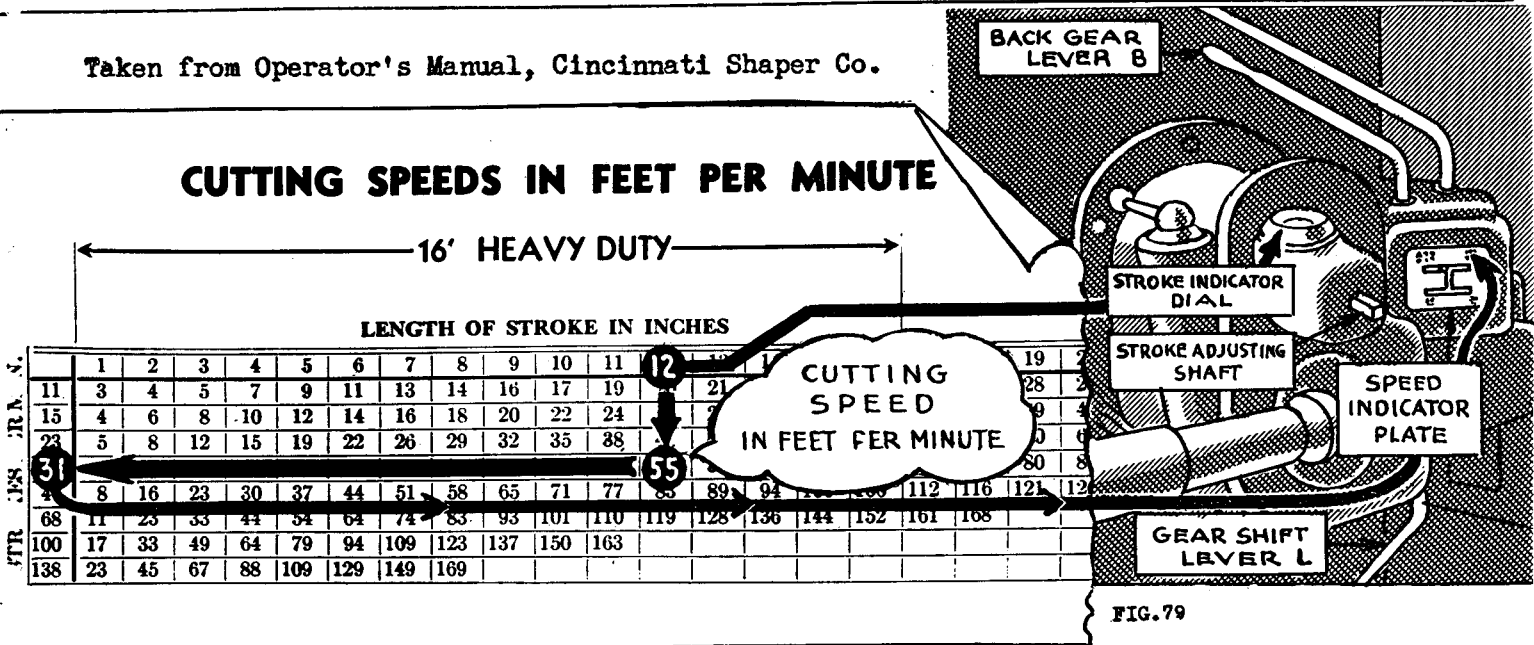

If the speed of this shaper is to be adjusted for the same job used in the previous example, proceed as follows and refer to Fig. 79.

1. On the chart of allowable cutting speeds, page 308, find the cutting speed for a roughing cut on cast iron. The speed recommended is 60 feet per minute.
2. Find number 12, which is the length of stroke required, in the upper row in the table of cutting speeds. (Refer to Fig. 79.)
3. Move down in the column under number 12, and stop at number 55, since this is the number which comes nearest to the recommended cutting speed of 60 feet per minute for roughing cast iron.
4. Move to the extreme left in the row opposite number 55. Number 31, appearing at the intersection of this row and the left-hand column, indicates the number of ram strokes for which the shaper is to be adjusted for attaining the approximately correct cutting speed.
5. By means of lever L, shift the speed indicator to the slot in the stroke plate under number 31.
6. Shift back-gear lever B to its position marked B.

FOR ADJUSTMENT OF THE SPEED
ON THE HYDRAULIC SHAPER,
REFER TO PAGE 94.

HOW TO ADJUST THE AUTOMATIC FEED ON A CONE-DRIVEN SHAPER

1. Read the description of the feed mechanism used on this type of shaper. (Refer to page 23.)
2. Determine, approximately, in thousandths of an inch, the amount of feed most desirable for the job, giving consideration to the factors which influence the selection of the proper amount of feed. These factors have been described in the section beginning on page 304.

3. Adjust the slide block out from the center of the feed disc or feed rocker arm, whichever is used, a distance estimated to produce the desired amount of feed, not forgetting that the farther from center the block is moved, the greater becomes the amount of feed.

NOTE: If the slide block is moved out from the center of one side of the feed disc or feed rocker arm, the feed will become operative during the cutting stroke; if the block is moved out from the center of the feed-regulating device on the opposite side, however, the feed will operate on the return stroke of the ram. This latter adjustment is preferable for most work. (Refer to Fig. 80.)

4. To determine the amount of table feed for which the shaper has been adjusted, apply the automatic feed; then pull the belt by hand and note how many thousandths of an inch the micrometer dial on the cross-feed screw advances for each stroke of the ram.

NOTE: The minimum amount of feed for which any shaper using this type of feed mechanism can be adjusted, is established by the amount of movement produced in the cross-feed screw when the feed pawl rotates the ratchet wheel one tooth only for each stroke of the ram. This amount, in thousandths of an inch, will vary with the number of teeth on the ratchet wheel and with the lead of the thread on the cross-feed screw.

5. Continue to make additional adjustments of the slide block in its feed-regulating device, if the first estimated setting does not result in the desired amount of feed.

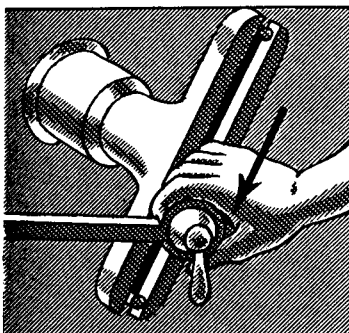
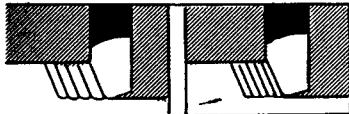
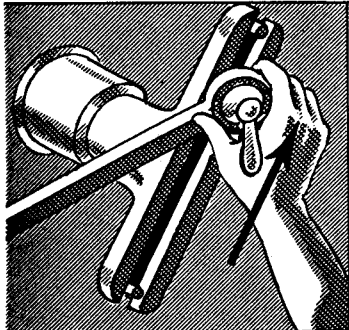
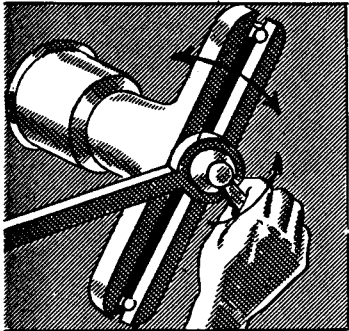
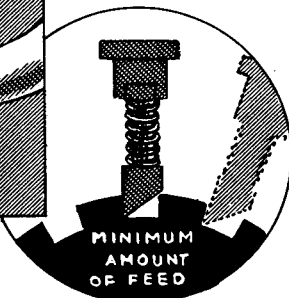

FIG. 80



HOW TO ADJUST THE AUTOMATIC FEED ON A SHAPER
USING A DIRECT-READING FEED DIAL

1. Read the description of this type of feed mechanism on page 28.
2. Determine, in thousandths of an inch, the amount of feed which will be desirable for the job. Base the selection of the amount of feed on those influencing factors which have been described in the section beginning on page 304.
3. Select from the numbers on the feed dial, the one which most nearly corresponds with the selected feed in thousandths. Then move this number on the dial to the index line, using whichever means has been provided for this purpose.

For example, the feed dials on page 28 have been adjusted for a feed of .090, .100, and .170 for dials A, B, and C, respectively.

HOW TO ADJUST THE TOOL HEAD

1. Read the description of the tool head beginning on page 14.
2. Loosen the binder bolts or other clamping devices which hold the swivel block to the end of the ram, if the position of the tool head must be changed.
3. Set the tool head to the position required for taking the type of cut specified. In other words, for vertical and horizontal cuts, set the head in a vertical position with the 90° mark on the swivel block opposite the index mark on the ram; or, for angular work, place opposite the index line on the ram whichever graduation on the swivel block will produce the desired angular cut. (Refer to page 227.)
4. Clamp the tool head in the selected position, making certain that the position has not changed during the clamping process.
5. By means of the ball crank on the down-feed screw, adjust the cutting tool so that it just barely clears the high point of the job.
6. Set the zero on the micrometer dial on the down-feed screw to its index line so that the depth of cut may be accurately determined. (Refer to page 65. Then, to prevent movement of the tool slide during the cut, tighten the screw on the tool-slide lock.

FOR ADJUSTMENT OF
THE AUTOMATIC FEED
ON THE
HYDRAULIC SHAPER,
REFER TO PAGE 95.

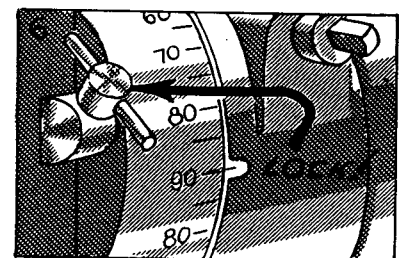
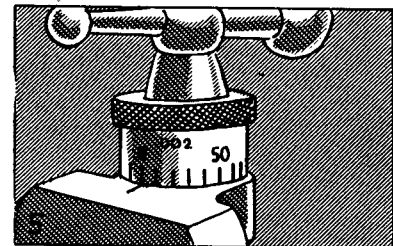
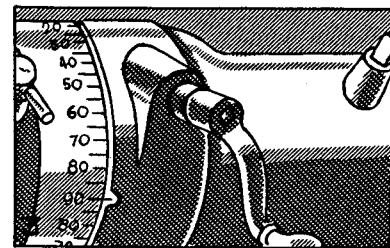

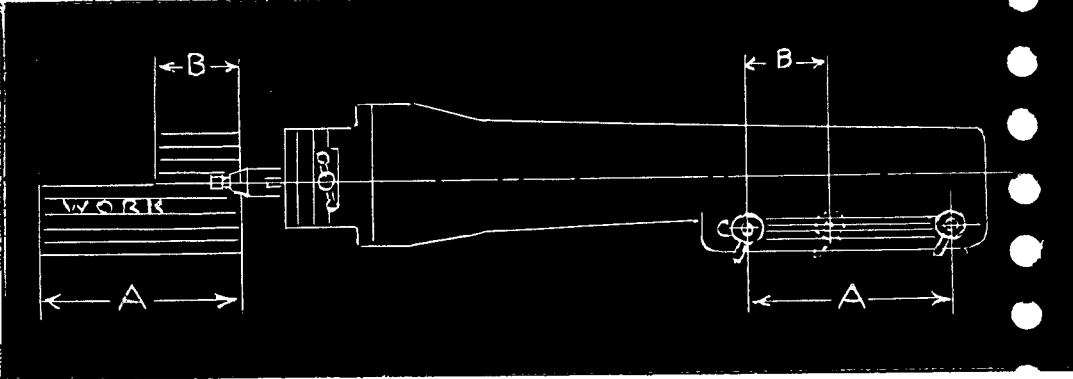
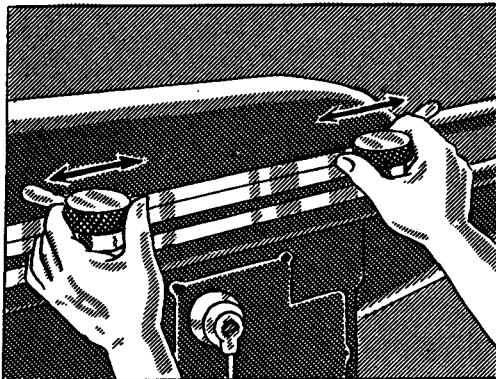

FIG. 81

HOW TO ADJUST THE STROKE AND THE POSITION OF THE RAM ON A HYDRAULIC SHAPER

1. Read the description of the pilot valve on page 45.

NOTE: Both the stroke-length and its position relative to the work may be adjusted simultaneously, since both these adjustments are controlled by the trip dogs on the ram. The position of the trip dog at the front determines how far the ram may travel toward the rear of the shaper; likewise, the position of the trip dog at the rear determines how far the ram may move forward, inasmuch as these dogs actuate the pilot valve which in turn causes the ram to reverse its direction of travel.

2. Measure the length of the surface to be planed after the work has been located in the shaper.
3. Turn the knobs on the trip dogs in order to loosen them so that they may be located about equidistant from the ends of the ram slot and spaced a distance approximately the length of the job for the purpose of making the trial adjustment.
4. Set the speed-control lever for one of the slower speeds on the shaper while the length and position of the stroke are being adjusted. (Refer to page 58.)

CAUTION

Make certain that neither the cutting tool nor the

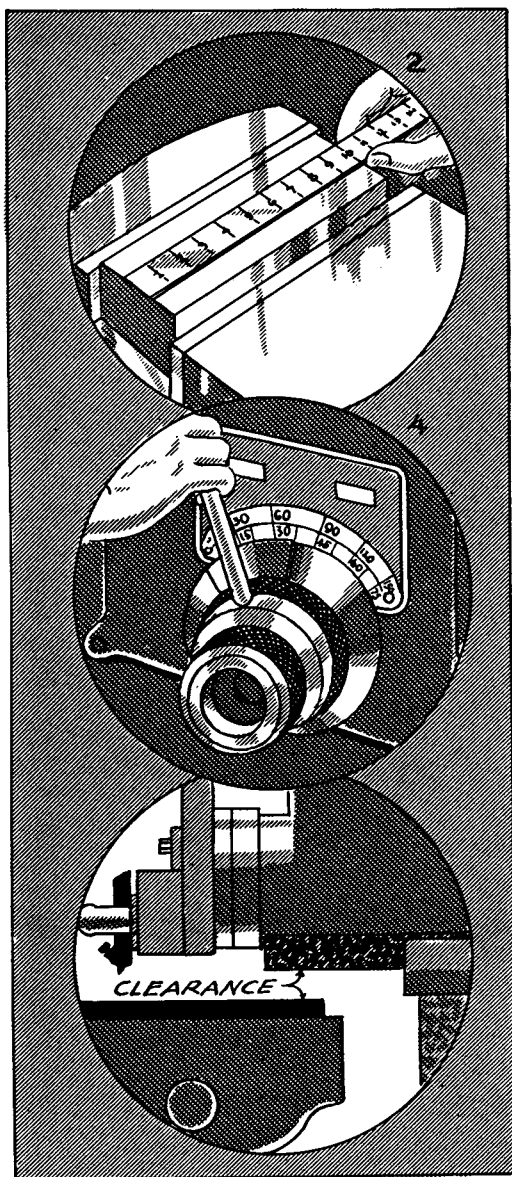

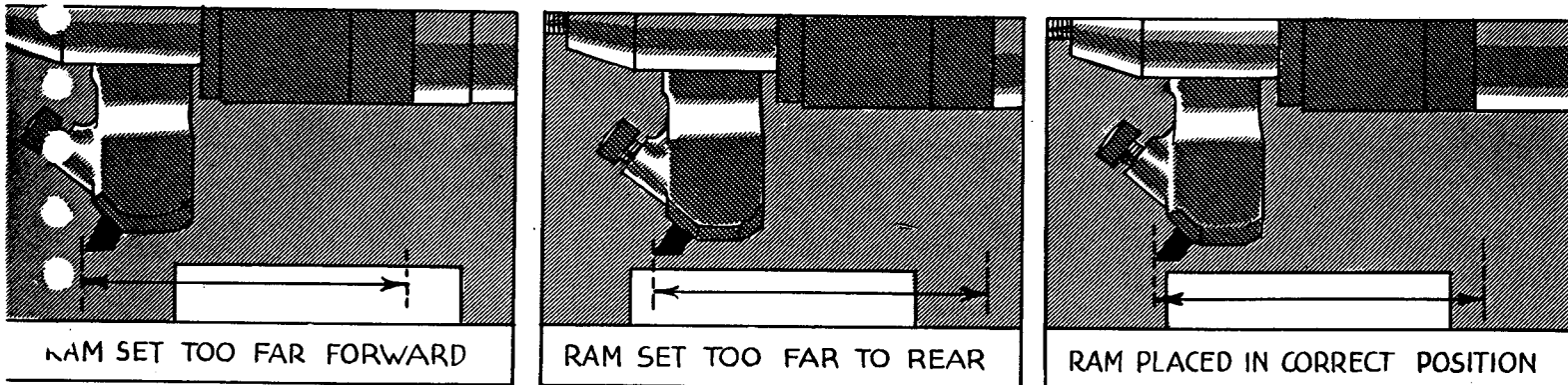
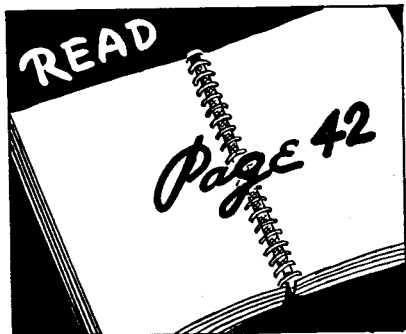

FIG. 82

ram will strike the work when the shaper is set in motion.

5. See that the control lever is in its "Stop" position before starting the motor which operates the pump for the hydraulic system. (Refer to pages 42 and 58.)
6. Cautiously start the shaper, and run the ram to its forward position; then stop the machine and note whether or not it is necessary to make a further adjustment of the trip dog which controls this end of the ram stroke. (Refer to page 64.)
7. If the cutting tool has run beyond the forward end of the work more than one-fourth of an inch (the desired clearance at this end), the rear trip dog has been improperly placed. To correct this condition, move the rear trip dog forward (to the left) a distance equivalent to the distance which the tool has overrun the job in excess of the usual quarter-inch allowance.
8. If the cutting tool, on the other hand, falls short of clearing the front end of the job by the desired distance, move the rear trip dog back (to the right) a distance equivalent to this deficiency. (Refer to Fig. 82.)
9. Make further adjustments of the rear trip dog if the first trial does not produce the result desired.
10. Start the shaper again and allow the ram to run to its rear position; then stop the shaper.
11. Observe the position of the cutting tool with relation to this end of the work. If the tool passes beyond the work more than three-fourths of an inch, move the front trip dog back a distance equivalent to the excess in length of the stroke. Conversely, if the cutting tool does not travel back sufficiently to clear the work by the required distance, move the front trip dog forward a distance equivalent to the deficiency in stroke length. (Refer to Figs. 81 and 82.)

HOW TO ADJUST THE SPEED OF THE RAM ON A HYDRAULIC SHAPER



1. Read the description of the flow-control and over-load-relief valve on page 42 and that of the start-and-stop valve on the same page.
2. Determine the cutting speed in feet per minute recommended for machining the kind of material in the job with the particular cutting material in the tool. (Refer to the Chart of Allowable Cutting Speeds - Feet Per Minute on page 308.)

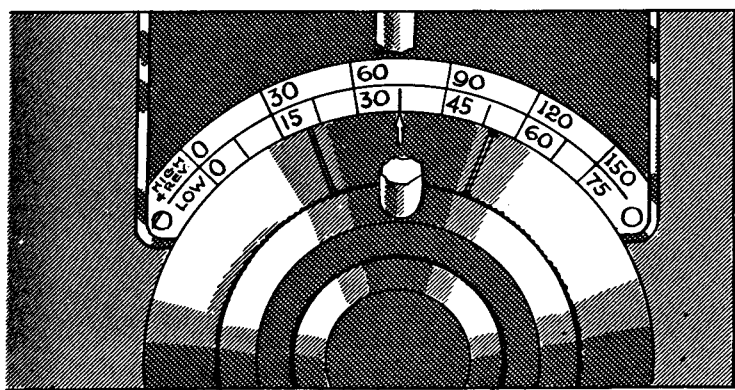
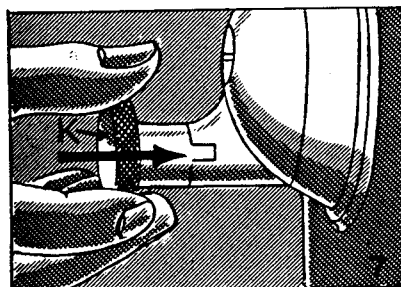
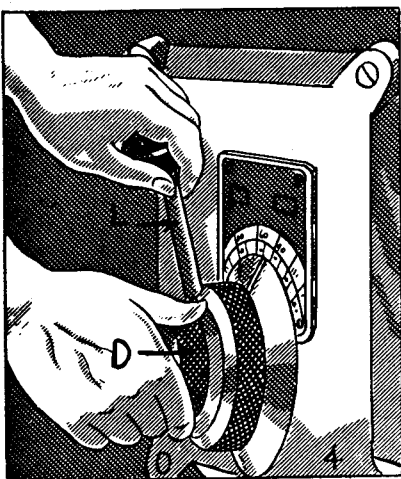

FIG. 83



3. Select from the speed-index plate on the shaper, the number which most nearly approximates that of the cutting speed in feet per minute as determined by consulting the Chart of Allowable Cutting Speeds (Fig. 83).
4. Loosen the knurled locking disc when it is necessary to change the cutting speed of the tool.
5. Move lever L in the direction necessary to place the adjacent index line under the desired cutting speed in feet per minute on the index plate. (Refer to Fig. 83.)
6. Lock lever L in position by tightening the knurled locking disc D.
7. For the series of slower speeds, and for heavy cuts, push in knob K on the starting lever. Then, when the entire setup has been completed and the shaper is ready to be set in motion, move the starting lever to its "Low" position.

NOTE: When the starting lever occupies this position ("Low"), any of the cutting speeds in the lower arc on the speed dial become available. It is necessary only to move the index line adjacent to lever L to any position desired in order to secure an infinite number of speed changes on this type of shaper. Obviously, the speeds in the upper arc are available when the starting lever is in its "High" position.

8. Pull out knob K on the starting lever and then

turn it through 180° when one of the speeds in the faster series has been selected, and when light cuts are to be made. Then move the starting lever to its "High" position, but only when the job setting has been completed and the machine adjustments have been made.

NOTE: The cutting speed of the tool in the hydraulic shaper, when once adjusted on its speed-index plate, remains constant even though the length of the stroke may be made shorter or longer. This is in contrast with the crank shaper in which the cutting speed changes whenever the stroke-length changes. This latter design, therefore, requires that the number of strokes per minute, and their length as well, be known in order that the cutting speed may be calculated. (Refer to page 301.)

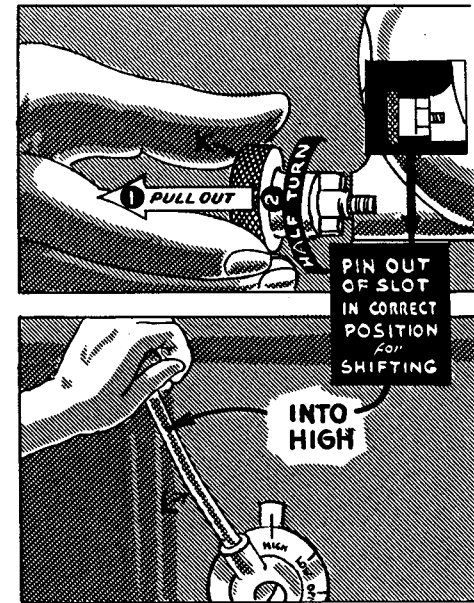

FIG. 84

HOW TO ADJUST THE CROSS FEED ON A HYDRAULIC SHAPER

1. Determine the amount of feed to be used. Base the estimate on the factors which affect the amount of feed which can be used, as indicated in the section beginning on page 304.
2. Move selector lever **B** toward the operator, bringing the word "Cross" on its hub to the index line.
3. Move the directional-reverse lever **A** in the direction in which the work is to feed: toward the operator for movement of the work in this direction but toward the column for feeding in the opposite direction. (Refer to Fig. 85.)
4. Close off the feed entirely by turning the handwheel **C**, shown in Fig. 86, to the right (clockwise).
5. Start the shaper with lever **L** (Fig. 84) after making

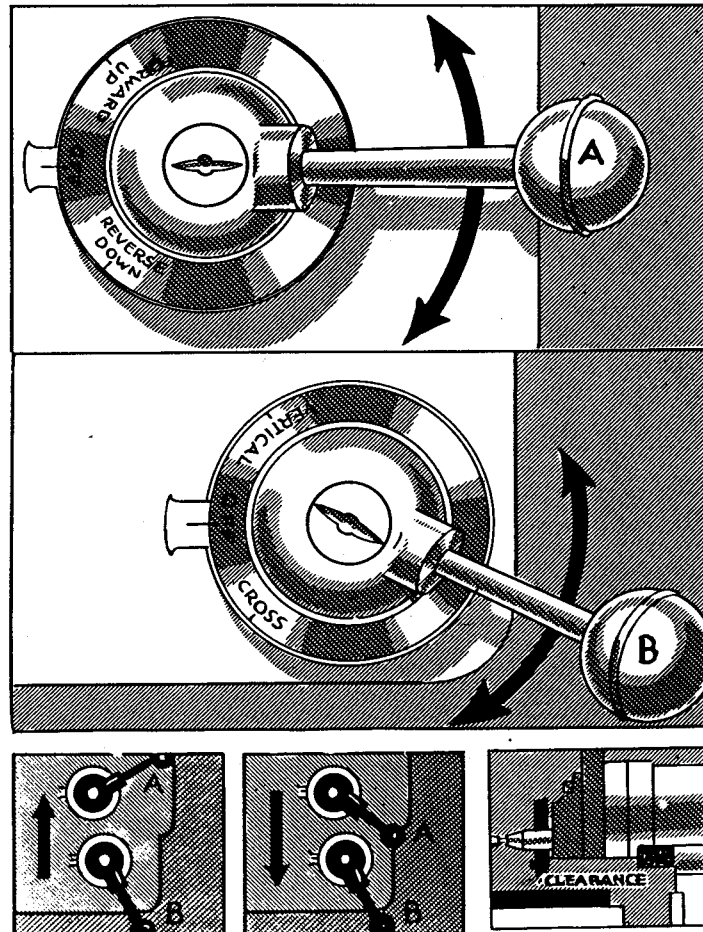

FIG. 85

certain that both the tool and the ram will clear all parts of the job.

6. Open the feed by slowly turning handwheel C to the left (counterclockwise) continuing the rotation of the handwheel until the graduated dial D on the cross-feed screw moves the desired number of thousandths for each cutting stroke.
7. Disengage the feed by moving reverse lever A in one direction or the other and aligning the word "Off" on its hub with the index line (Fig. 85).

HOW TO ADJUST THE VERTICAL FEED ON THE HYDRAULIC SHAPER

1. Determine the rate of feed which is to be used, giving consideration to the influential factors mentioned in the section beginning on page 304.
2. Move selector lever B toward the column of the shaper, thus

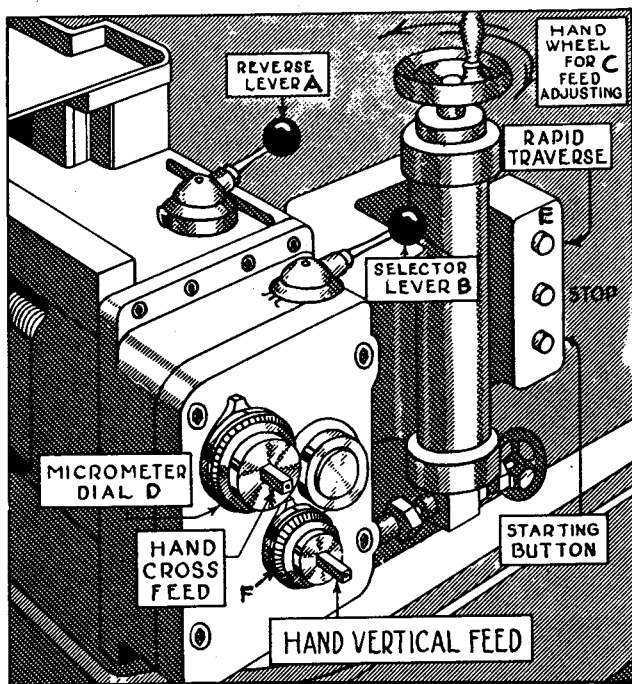

3. Move the directional-reverse lever A in one direction or the other so that either the word "Up" or the word "Down" appears opposite the index line, depending upon which vertical movement is desired (Fig. 87).
4. Repeat step No. 4 on page 95.
5. Repeat step No. 5 on page 95.
6. Open the feed by slowly turning the handwheel C to the left (counterclockwise) continuing the rotation of the handwheel until the graduated dial F on the elevating shaft moves the desired number of thousandths per stroke.
7. Repeat step No. 7 above.

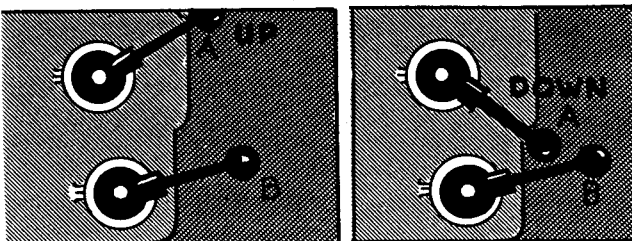

FIG. 86 FIG. 87

NOTE: The rapid power traverse unit which functions in connection with the feed mechanism has been described on page 46; its operation has been explained in How to Operate Rapid Power Traverse on the Hydraulic Shaper on page 62.

DESCRIPTION OF WORK-HOLDING DEVICES

Unit 1-T52(B) Pages 97 to 116

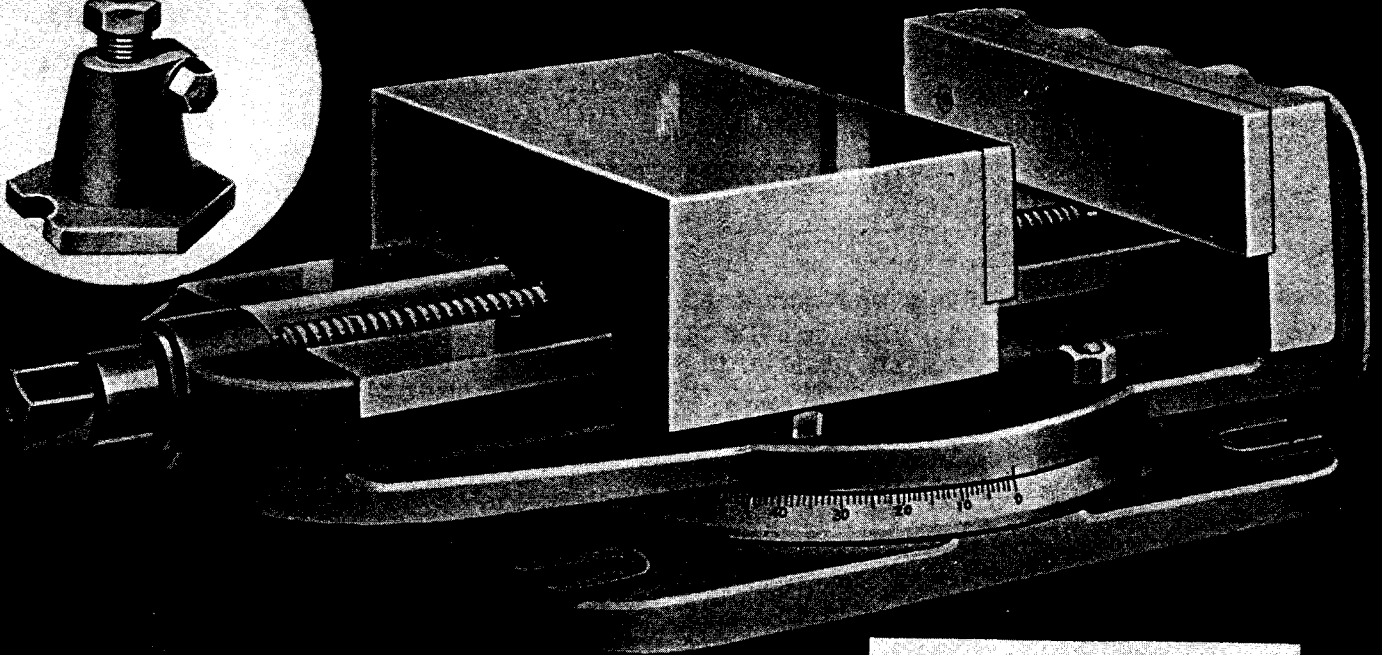
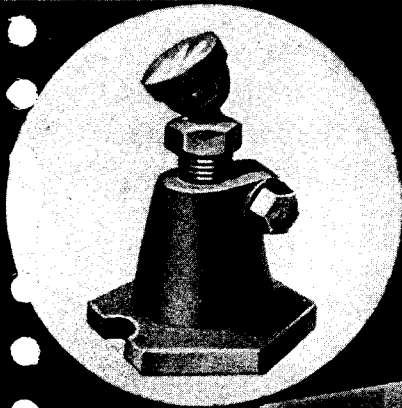
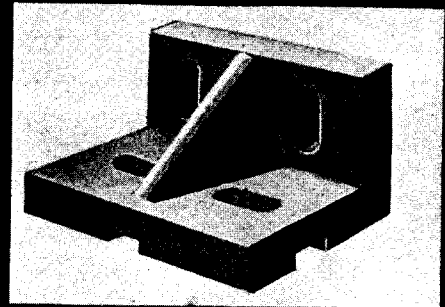

Photo by courtesy of Western Machine Tool Works



UNIVERSITY OF THE STATE OF NEW YORK
STATE EDUCATION DEPARTMENT
BUREAU OF INDUSTRIAL AND TECHNICAL EDUCATION

DESCRIPTION *of* WORK HOLDING DEVICES

OBJECTIVES OF UNIT

1. To describe the principal types of shaper vises.
2. To describe other types of holding devices.
3. To discuss some of the reasons, advantages, and disadvantages for the selection of the type of holding device.

INTRODUCTORY INFORMATION

The manner of holding the work in the shaper is an important part of shaper operation, and, although the devices used are simple, they can be arranged in numerous ways and combined to accommodate a wide variety of work. It is, therefore, essential that the shaper operator be familiar with the different types of holding devices and be acquainted with some of their particular features so that he can intelligently select the most suitable method of holding the work.

Most of the small work is held in the shaper vise which is bolted to the top of the work table. If, however, the work is too large or for any other reason cannot be held in the vise, the vise can be removed and the work secured to the top or, in some instances, to the side of the table.

Ordinarily, the shaper table is large enough to support the whole area of the work, but there are times when large pieces that extend beyond the shaper table can be conveniently machined if the overhanging portion is given additional support. The limiting factors for this procedure are the length of the stroke, the ability of the tool to reach the surface to be finished, and the advisability of using the shaper for the work to be machined.

Sometimes, what appears to be a very complex setup can be made comparatively simple by using a holding device called a fixture, and, although fixture design is beyond the scope of this manual, nevertheless, simple arrangements of standard holding devices combining the methods of holding work as set down in this section, are not beyond the ability of the intelligent shaper operator to suggest or even to design.

DESCRIPTION OF WORK-HOLDING DEVICES

THE SHAPER VISE

The principal parts of the vise are the base, the body, the fixed jaw, the movable jaw, the screw, the handle (or wrench), and the plates which are attached to the face of the jaws.

The bases of the vises (Figs. 89, 91, and 92) are bolted to the table by either three or four bolts, the number of bolts depending upon the design of the base. The base is graduated through an arc of 180° with a zero (0) position on the left side, a zero (0) position on the right side, and with a 90° mark in the front, midway between the two zero marks. On the underside of the base are provided square keys which fit into the table slots and which square the base on the shaper table.

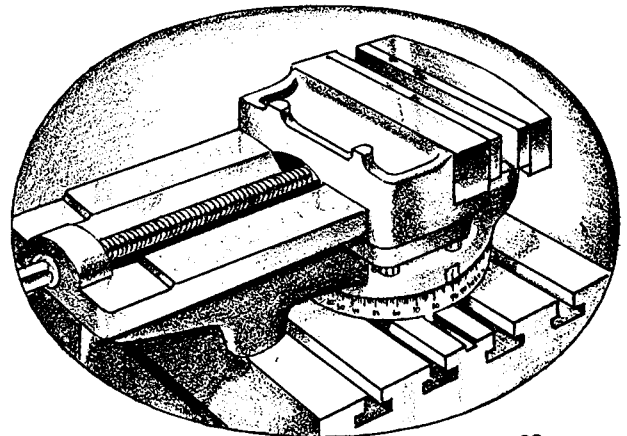

FIG. 88

The body of the vise is a semisteel casting which fits on the base of the vise (Fig. 89). The heads of the bolts, which are free to slide, are held in a circular groove in the underside of the body. When the vise is being assembled, the bolts pass through holes in the base and holes in the table as shown in Fig. 90. Washers and nuts are placed on the bolts which extend into the openings and, when tightened, secure the vise and base to the table. When the nuts have been loosened, the vise can be swiveled to form any angle with the direction of the stroke. The pilot in the base provides a central point about which the body of the vise swivels.

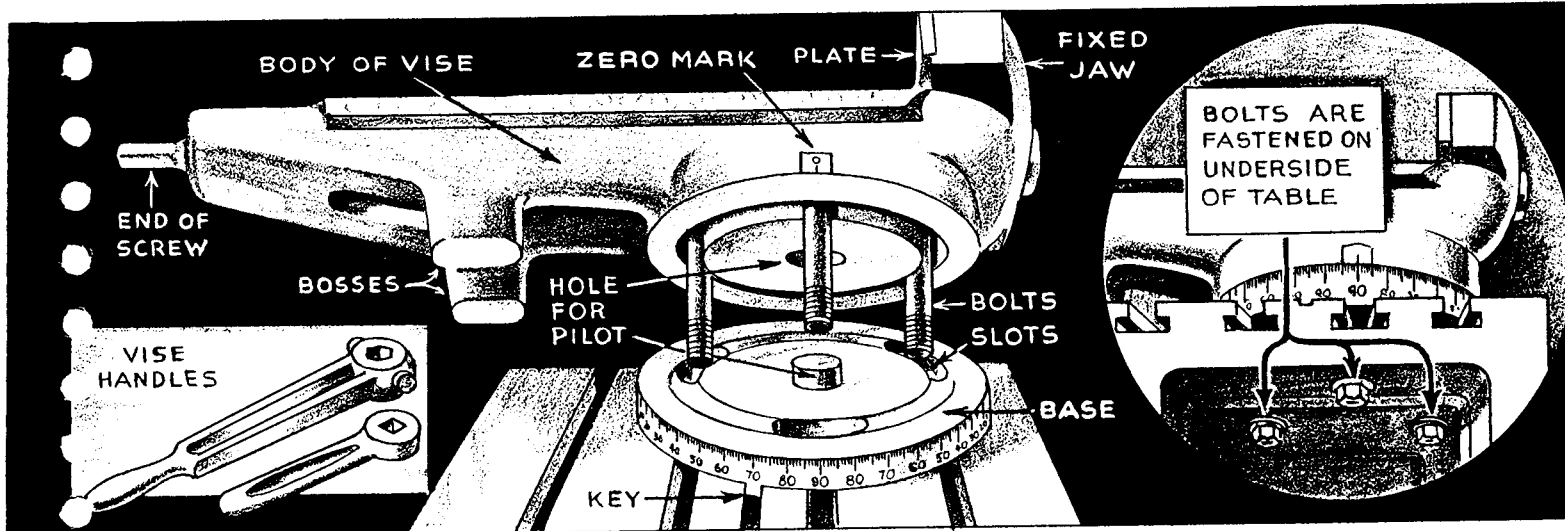

FIG. 89

FIG. 90

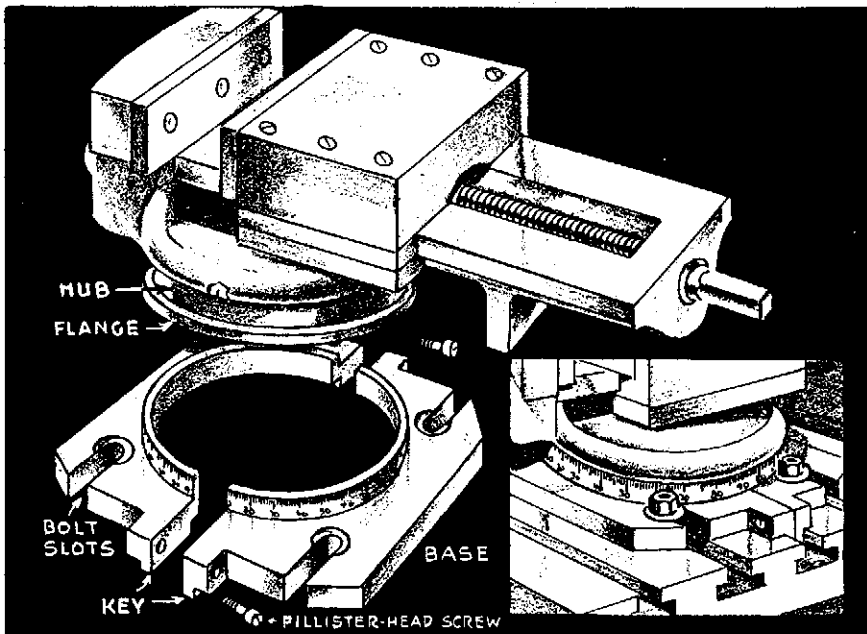

FIG. 91

In the design shown in Fig. 91, the base acts as a clamping ring for the body. It is split so that it can be assembled on the projection called the hub (Fig. 91) on the underside of the body of the vise. Two fillister-head screws hold together the two halves of the clamping ring, or base. The vise may be swiveled to any angle horizontally and, consequently, when the nuts which hold the base to the table are tightened, they exert a downward pull on the flange of the hub and hold the vise securely in position.

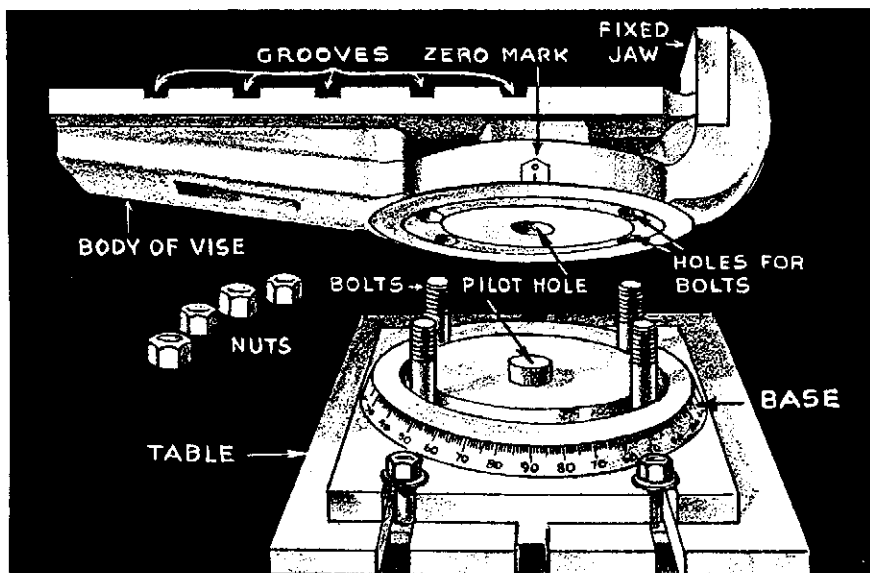

FIG. 92

The base illustrated in Fig. 92 is bolted to the table of the shaper and is held independently of the vise body (Fig. 92). The base is made with a circular T-slot to receive the heads of four T-bolts. The bolts project above the base and are made long enough to pass through the flange on the bottom of the vise and to hold a washer and a nut. When the nuts are loosened, the vise may be swiveled horizontally to any desired angle. The vise is securely clamped to the base when the nuts are tightened (Fig. 93).

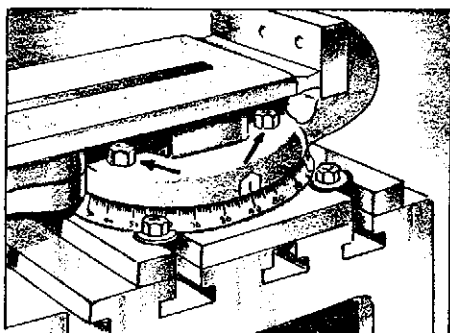

FIG. 93

The vise (Fig. 89) has bosses which are cast on the underside of the vise body. The bosses provide additional support when wide pieces are held between the jaws or when the vise is used with the jaws at right angles (90°) to the direction of the cut. When the vise is in this position and the work is held vertically, the jaws should be offset to permit the ends of

bars to be machined (Fig. 94).

The solid, or fixed jaw, (Fig. 96) is an integral part of the vise body and is machined square with the surfaces upon which slides the movable jaw (Figs. 95 and 96). Both the fixed and the movable jaws are usually faced with either annealed or hardened and ground steel plates. Although hardened and ground plates hold their accuracy better and their surfaces are not so easily damaged, annealed plates have a slightly greater gripping power. The plates may be removed by taking out the screws which attach them to the jaws. This becomes necessary only if the plates need to be reground or machined.

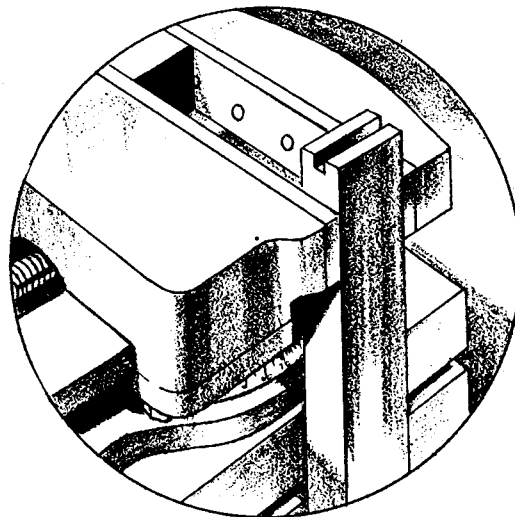
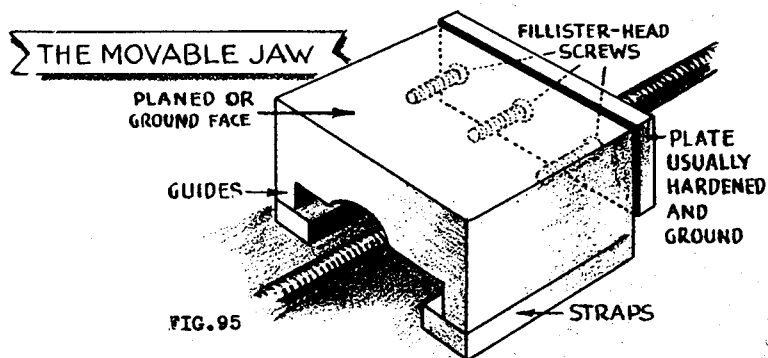

FIG. 94

Movable vise jaws are operated by either single or double screws. The movable jaw (Fig. 95) is operated by a single screw and is provided with guides to hold it square. The straps are bolted to the underside of the block and are adjusted to allow the movable jaw to slide without the tendency to lift excessively.



The vise screw passes through a nut which is attached to the bottom of the movable jaw; two bearings, one at each end of the casting, support the screw (Fig. 96). A large washer is placed on one end of the screw to receive the pull caused by the tension on the screw when the vise has been tightened. The lock nuts or adjustable collars hold the washer in place and provide for necessary adjustment. The movable jaw of the single-screw vise has a flat top which

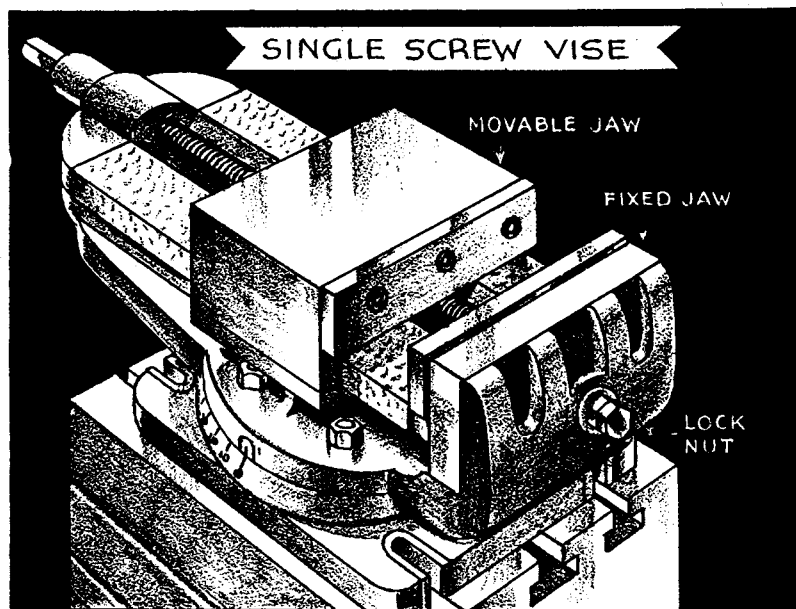

FIG. 96

may be used as a surface plate for use with measuring instruments.

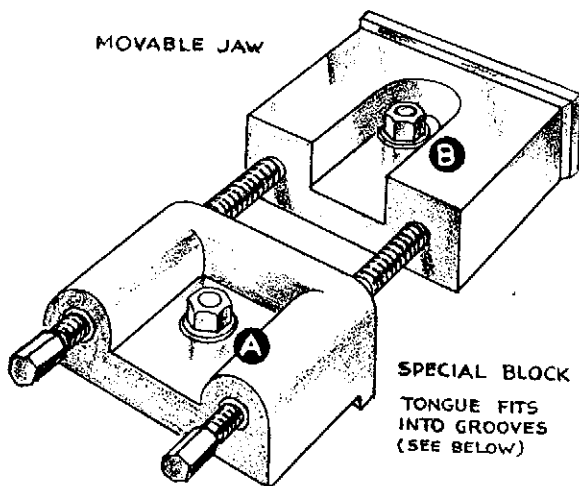

FIG. 97

A vise also may be equipped with double screws (Fig. 97). The movable jaw of this vise is made without guides and, in addition to holding straight work, it will hold work with a slight taper. When the nut B has been loosened, the movable jaw can be moved forward by hand until it is against the work. The jaw is forced against the object by two setup screws which are held in a special block and which can be adjusted to suit the position of the movable jaw. When the nut A (Fig. 98) has been loosened, the special block may be raised so that the tongue on the underside may be lifted clear of the groove. The block may then be moved to any position in which the tongue and groove coincide and in which the adjustment is enough to allow the screws, when turned, to force the movable jaw against the work. When the nut A has been tightened, pressure can be applied to the movable jaw by tightening the two setup screws. Finally, the nut B must be tightened to hold the movable jaw firmly against the surface of the vise body.

to allow the screws, when turned, to force the movable jaw against the work. When the nut A has been tightened, pressure can be applied to the movable jaw by tightening the two setup screws. Finally, the nut B must be tightened to hold the movable jaw firmly against the surface of the vise body.

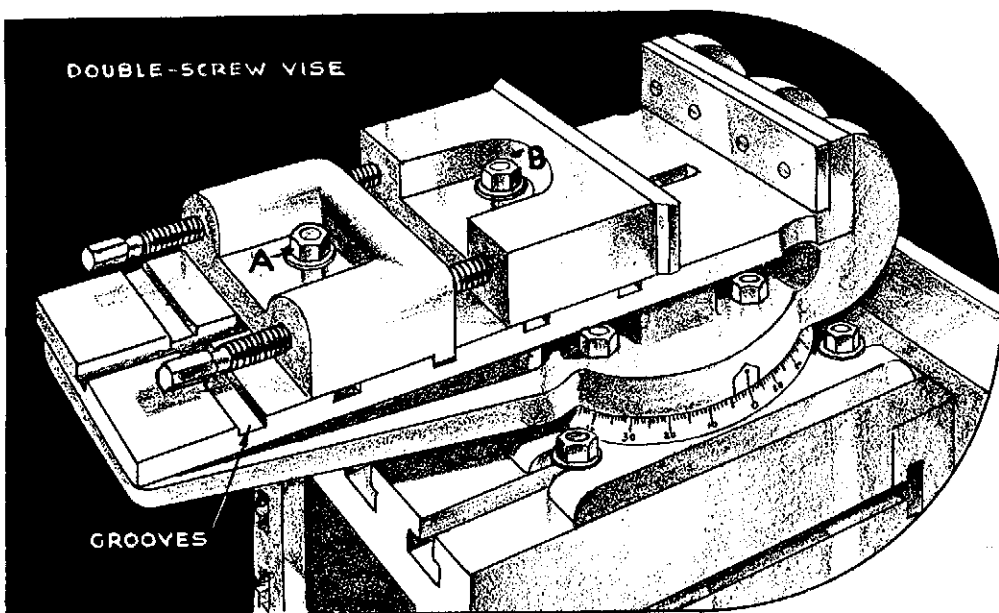
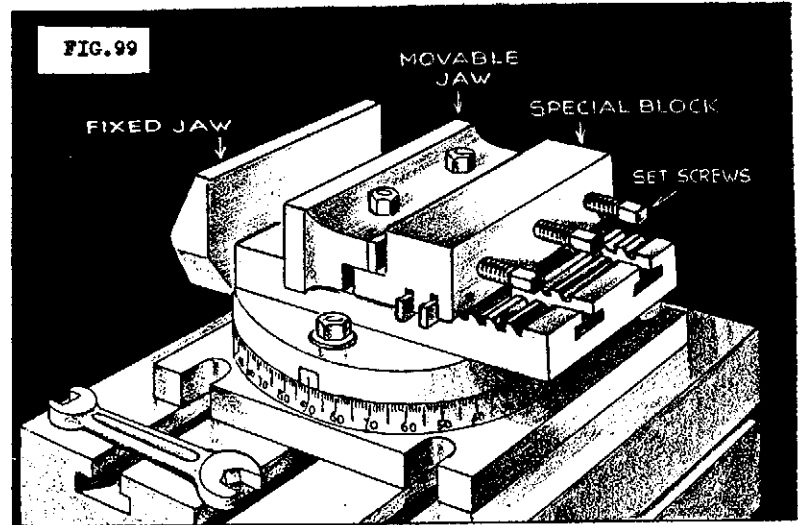

FIG. 98

The shaper and planer vise illustrated in Fig. 99 is frequently found in machine shops. The vise embodies the same principle as the double-screw vise, but the special block which holds the set screws is furnished with two plates in-

stead of the tongue and groove used in the previous design (Fig. 98). In addition, the block has a ledge upon which rests the undercut surface of the movable jaw. Three smaller set screws take the place of the two heavier screws with which double-screw vises are equipped. The jaws of this vise are not faced with steel plates.



The selection of either the single- or double-screw vise will depend upon the nature of the work. The preference for the single-screw vise is

based upon the fact that the single-screw type is simpler and quicker to operate; on the other hand, the double-screw vise has the advantage of being able to hold work with a slight taper and to hold the movable jaw very securely against the work.

For tapered and irregularly shaped pieces, a vise (Fig. 100) with a swiveling movable jaw may be used. The jaw is pivoted on a central stud which allows the jaw to align itself against the side of the object. Two bolts are used to clamp the jaw in position. It should be observed that the screw draws the swiveling jaw to the work instead of forcing the jaw forward. Whenever the vise is to be used to hold regularly shaped pieces with parallel sides, the swiveling jaw must be set in line with the fixed jaw. This is accomplished by using a dowel pin which is provided for locating the swiveling jaw in proper alignment with the fixed jaw.

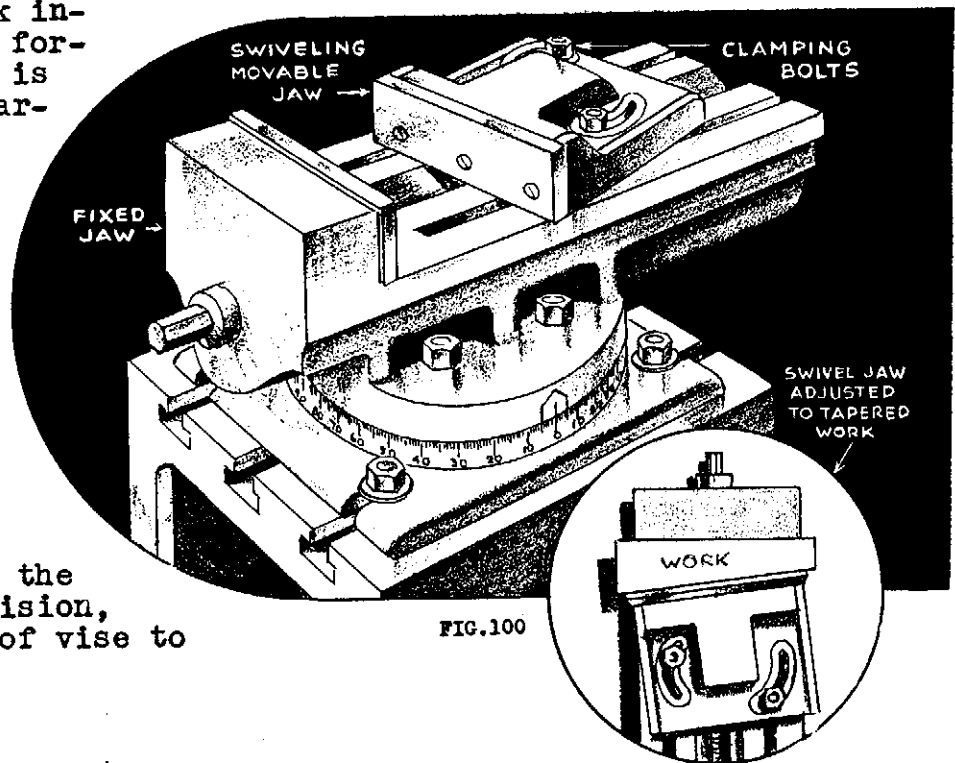

Manufacturers of shapers supply a vise as part of the regular equipment of the machine, leaving the decision, however, as to the type of vise to the purchaser.

PARALLELS

It is not always practicable to place the work between the jaws of the vise or to lay the work directly on the table without some supporting piece underneath. Sometimes projections on the underside of the work require that the piece be raised to clear the projections, or it may be necessary to raise the work a definite amount, or otherwise to simplify the machining operations. These supporting pieces are called parallels (Fig. 101). They are square or rectangular bars A made in pairs of either cast iron or steel. Frequently parallels are made by cutting off two pieces from a square or rectangular bar of cold drawn steel, or they may be accurately machined to any desired size. For general shaper work, the larger parallels are often made of cast iron and have grooves cut the entire length of their surfaces as shown at B. The purpose of this is to lighten the parallels somewhat and present less area to be cleaned and to be kept free of burrs. Another method of lightening parallels is to undercut the sides and cut holes in the webs as illustrated at C. When extreme accuracy is required, the parallels are made of steel which is hardened, seasoned, and ground.

There is no definite standard as to how high, wide, or long a parallel must be. Opinions vary as to what are the most suitable sizes to have available for use with the shaper. Manufacturers usually sell parallels in sets which are designed so that when used singly or in combinations they will give a wide range of sizes. For general shaper work, parallels should range progressively from about 1/8" high, 1/4" wide, and 6" long, up to about 3" high, 1-1/2" wide, and 12" long. To suit special purposes, however, it is often more economical and more practicable to make or purchase a set of parallels instead of using available parallels in combination.

Occasionally, adjustable parallels D very conveniently can be used to support the work in the shaper vise. As the parallels can be set and locked to micrometer measurement, any height from 3/8" to 2-1/4" can be obtained with a set of these parallels.

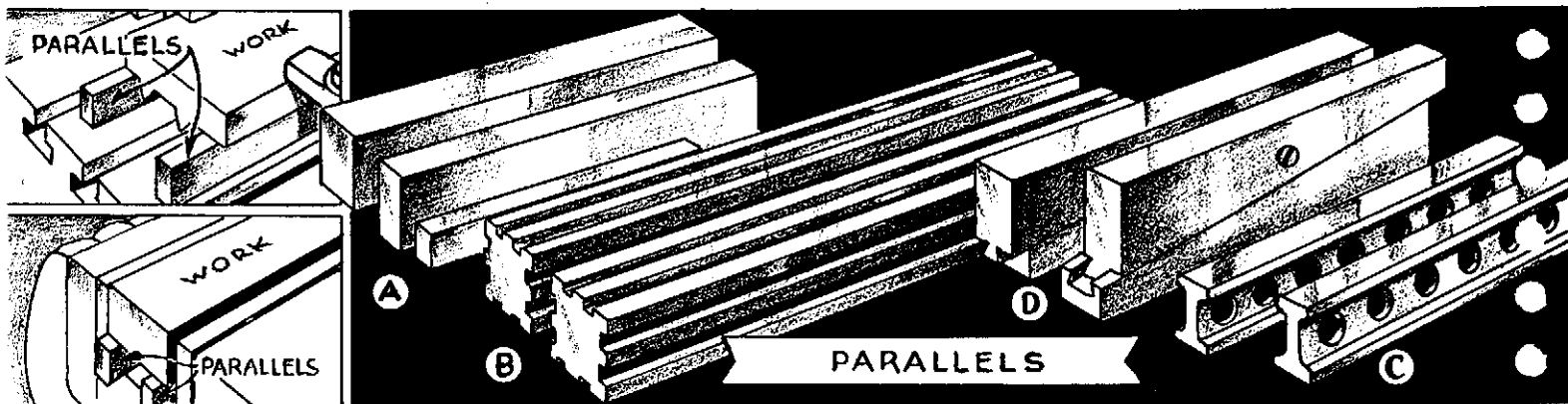

FIG. 101

SHAPER BOLTS

The most convenient method of fastening work or work-holding devices to the table is by the use of T-head bolts. For holding vises and many other types of work and work-holding devices, the square T-head bolt (Fig. 102) is ordinarily used. The heads of these bolts fit into T-slots which are cut in the shaper table. The square T-head bolts must be inserted in the end of the slot and moved along lengthwise to the desired position. The bolts cannot turn in the slot or be lifted out of the slot, which, of course, is the purpose of the square head and the T-slot.

For use with some setups, it is more convenient to place the bolt in the slot after the work has been placed on the table. For this reason, a cut-away T-bolt (Fig. 102) is manufactured. This bolt can be inserted into the slot and then turned. The head is made narrow enough so that it can be placed in the top of the slot, and, as the length is longer than the width, a partial turn of the bolt causes the head to catch on the side of the T-slot and thus prevents the head from further turning. Besides, the head catches on the underside of the slot and prevents the bolts from being pulled out.

For types of work in which different lengths of bolts are required, the tapped T-head bolt (Fig. 102) is frequently used. The head, or block, is tapped to receive a stud which may be made to any desired length and on which a thread is cut on both ends. The head of the bolt can be inserted into the T-slot and moved along to the assigned position. The stud is then screwed into the head as far as the shoulder of the thread will permit. The shoulder will prevent further turning of the stud in the head when the nut is being tightened. The assembled bolt, likewise, is held in the slot by the head. A nut and a washer are furnished with each bolt.

Bolts, alone, are limited in their use to objects that have holes or slots to receive them. Used with clamps, however, bolts may be utilized for innumerable purposes.

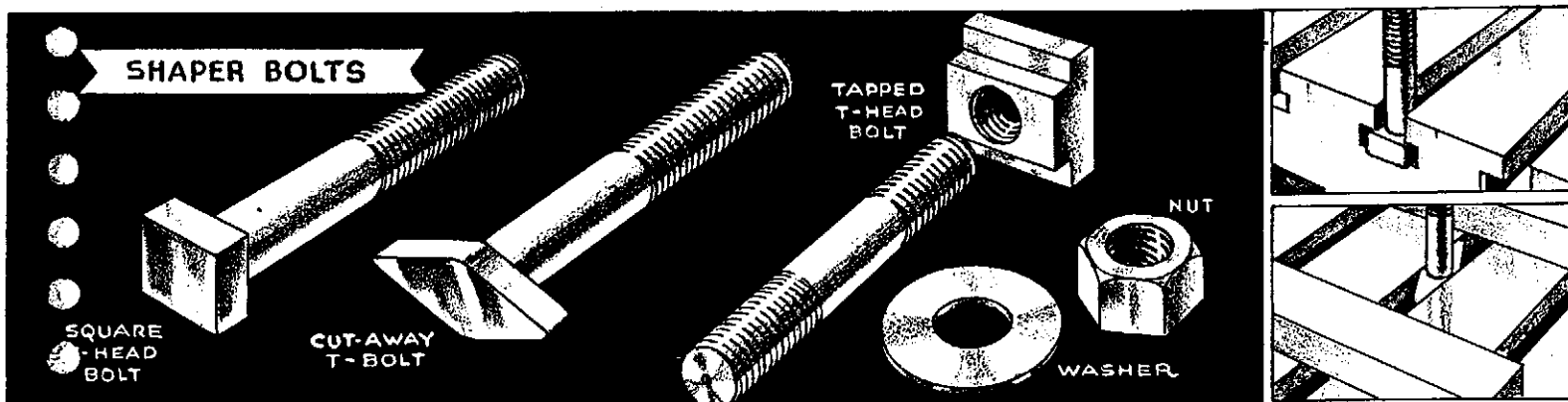

FIG. 102

STRAPS OR CLAMPS

Clamps are designed to hold objects which have a wide range of sizes and shapes. Usually the styles purchased from the manufacturers are sufficient for most purposes, but there are occasions when special ones must be made. As clamps are subject to severe usage, they should be made of tough, heat-treated steel.

The plain clamp, illustrated in Fig. 103, is stiff and strong and is used for general clamping purposes. It is made with an elongated slot, or hole, through which the T-bolt passes. The bottom of the clamp is flat; the top and the sides taper. The shape of the work to be clamped must be such that the clamps can be placed in a position which will not interfere with the machining of the surfaces.

An exceedingly useful clamp is the U-clamp (Fig. 104) which is made with a continuous slot, and is open at one end. The U-clamp has an advantage over the plain clamp which has a closed slot, because it can be removed without taking the nut off the T-bolt, and the bolt can be located in the most advantageous position for clamping by pushing it along the slot in the clamp. The disadvantage of the U-clamp is that it has a tendency to spread and bend under heavy clamping pressure. The U-clamp may be purchased with or without a finger, but although the finger adds to the usefulness of the clamp, it is better to use the latter type (Fig. 105) whenever this type can be employed.

When a finger clamp is used, the finger is usually supported in a drilled or cored hole in the work. This is a convenient method of holding the work without interfering with the machining operations. Drilled holes, however, may be objectionable, and, unless a cored hole is available, another type of clamp must be used.

Duplicate pieces with cored or drilled holes in their sides can be held with a

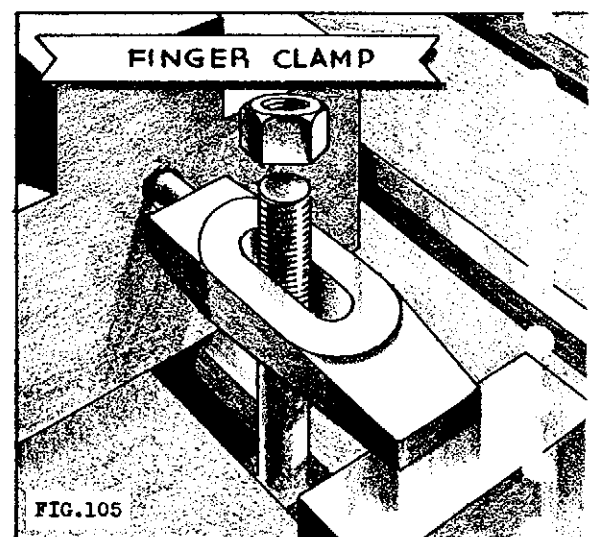
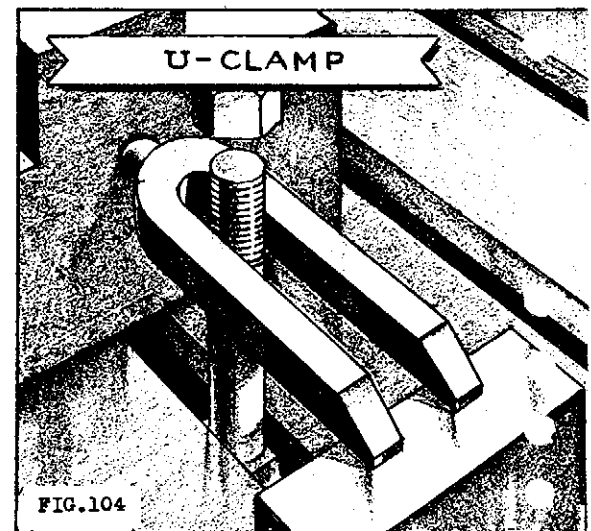
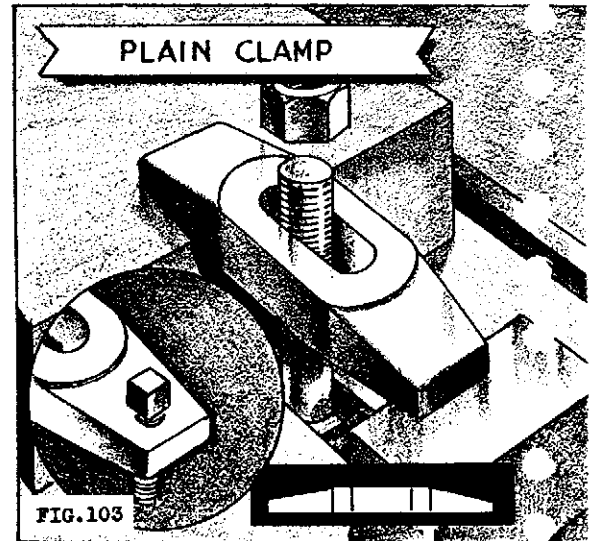

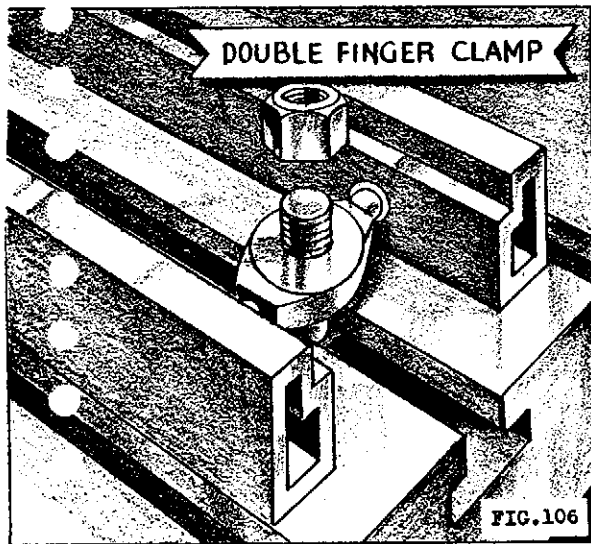

double finger clamp illustrated in Fig. 106. As the double finger clamp is a little shorter than the usual style of clamp, the work can be placed so that one bolt will clamp the two pieces .

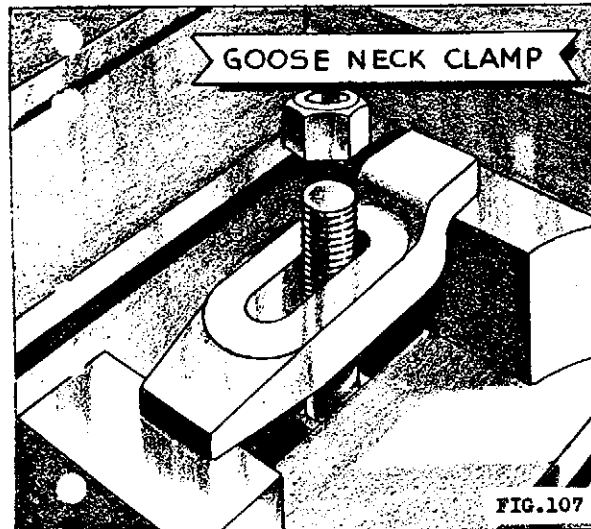

A gooseneck, or offset clamp is shown in Fig. 107. The offset feature of this clamp allows the top of the clamping bolt and the nut to be below the surface to be planed.

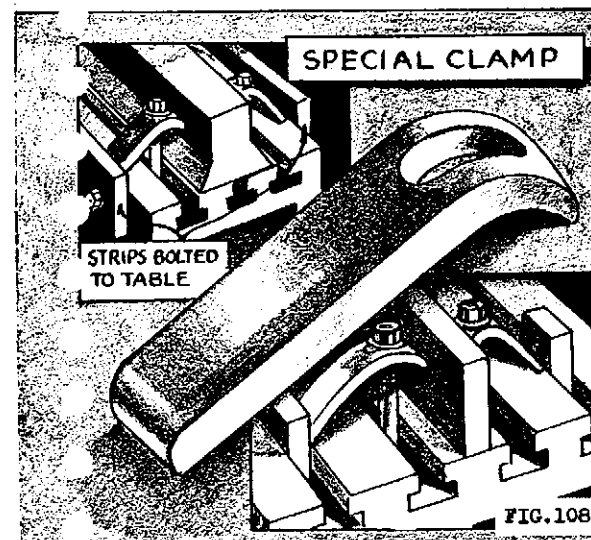

The adjustable clamp shown in the insert (Fig. 103) is similar to the plain clamp, except that the adjustable clamp has a set screw in a tapped hole opposite the clamping end. This adjustable device allows the back of the clamp to be raised or lowered by turning the screw to the right or to the left. By this means the clamp may be quickly adjusted to the height of the clamped surface without the use of packing strips. The single-point contact of the screw may or may not be an advantage. If the part to be clamped has a curved surface, there will be a tendency for the clamp to slide off the work. In contrast, if the clamped surface were flat but set at an angle causing the clamp to be tilted slightly sideways, then the single-point contact of the screw would be an advantage. The final decision, as to whether an adjustable clamp or a plain clamp is to be used, must be left to the judgment of the individual.

The clamps previously described are usually adequate for most clamping purposes, but occasionally a special clamp is preferable, such as the one illustrated in Fig. 108. The clamps are placed between stops inserted in the table slots and the work to be clamped. When the nuts on the bolts are tightened, the work is forced downward on the table. It should be noticed that four slots in the table are required for this setup; whereas most shaper tables are provided with three slots. This deficiency can be overcome, however, if a strip is clamped on both sides of the table and allowed to project above the top of the table about one inch in order to take the thrust of the clamps. (See Fig. 108.)

STOPS

Stop pins (Fig. 109) are used to prevent movement of the work on the table. They can be placed at the ends or along the sides of the work in order to take the thrust of the tool, or they can be used to hold the work to the table. For locating the stops in relation to the work, the table is provided with holes in addition to the T-slots. Plain stops, as shown at A, may be round or square pieces of steel turned down at one end to fit the table slots or the reamed holes in the table. Often stop pins are plain blocks, B, which can be inserted into the table slots, or they may have holes drilled or slots cut through the center so that they can be held to the table with bolts. Others, D, are provided with steps which catch on the underside of the T-slots. These are inserted in the ends of the T-slot and then pushed along to the required position. The stops, illustrated at C, D, and E, are tapped to hold set screws which can be tightened directly against the work or can be used in connection with toe dogs (Fig. 110). The screws are set either straight or at an angle, those set straight usually being used to take the thrust of the tool and the ones inclined at an angle used to exert a downward pressure when the work is being held.

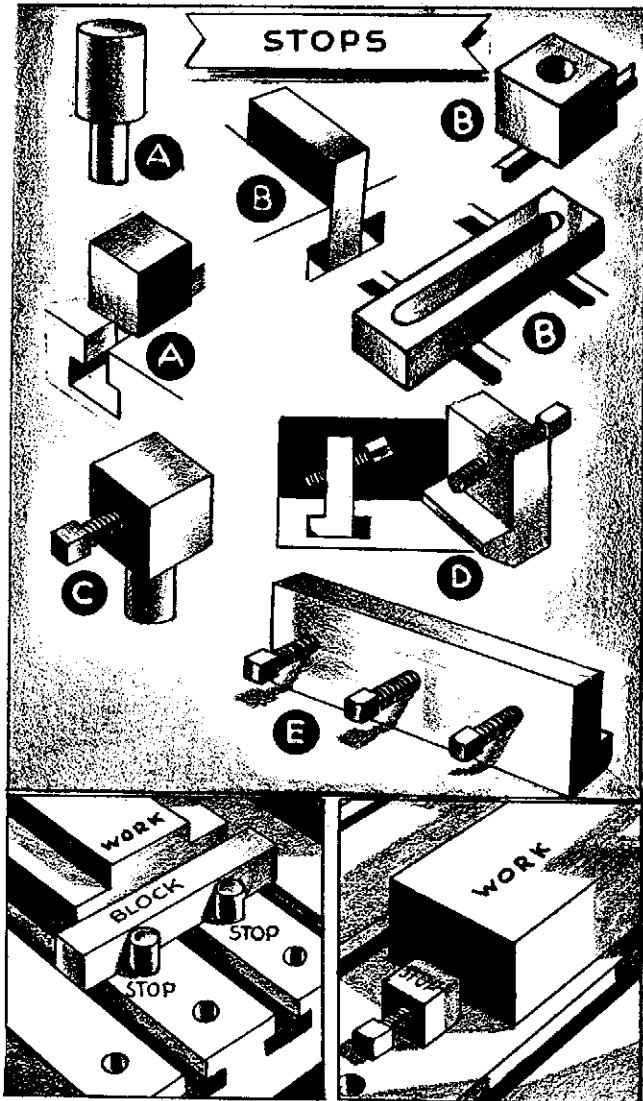

FIG. 109

TOE DOGS

A similar method of holding work is employed when thin material is held on the table with toe dogs (Fig. 110). The dogs are forged from round stock with either a flat end as shown at A or a pointed end as shown at B. At the opposite end, a counterbored hole is made to receive the end of a screw which is used to force the toe dog against the work. The narrow edge or the point of the dog, whichever is used, allows clearance for the tool when thin metal is being planed, while the slight angle at which the dog is set holds the work securely to the table.

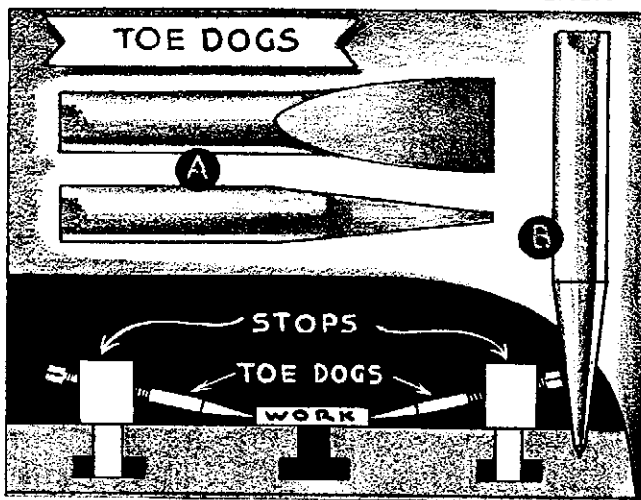

FIG. 110

HOLD-DOWNS

Hold-downs (Fig. 111) are thin, wedge-shaped pieces of hardened and ground steel used principally to hold work in the vise. The larger edge, which is placed against the vise jaws, is ground at an angle of 92° with the underside; the thin contact edge is left square with the bottom, or, in some cases, is rounded slightly. When the job and the hold-downs have been placed in position, and the jaws of the vise have been tightened, the hold-downs are tilted slightly, a position which forces the work down on the supporting surface.

This method is used to hold flat work which cannot be held conveniently by other methods. It is especially suitable for holding thin metal and for holding a job when a small amount is to be removed from the surface. With this arrangement, the work can be held securely without distortion, and, at the same time, there is ample room for manipulating the shaper tool.

ALIGNING STRIPS, OR BARS

Aligning strips (Fig. 112) are placed on the shaper table as a guide to setting the work parallel, at 90° , or at an angle to the direction of the stroke. They may be used also as stops against which the end of the material may be placed when duplicate lengths are being cut off from a piece of stock. Aligning strips can be plain bars, as illustrated at A and B. They may both be held to the table with clamps and bolts and, in the case of B, with bolts which pass through the slot. These strips may be located and set in any desired position on the table, but they should be securely braced with stops to prevent their shifting if the work is held against the strips with set screws.

The two styles of aligning strips illustrated at C and D are provided with tongues which fit into the table slots. This limits the use of these strips to being set parallel with the travel of the tool as shown in the inserts E and F. The tongues, however, make possible a quick and easy alignment of the strips par-

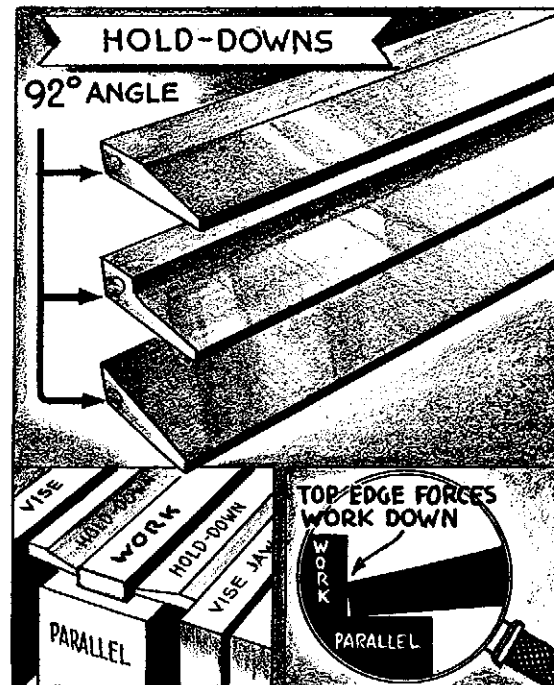

FIG. 111

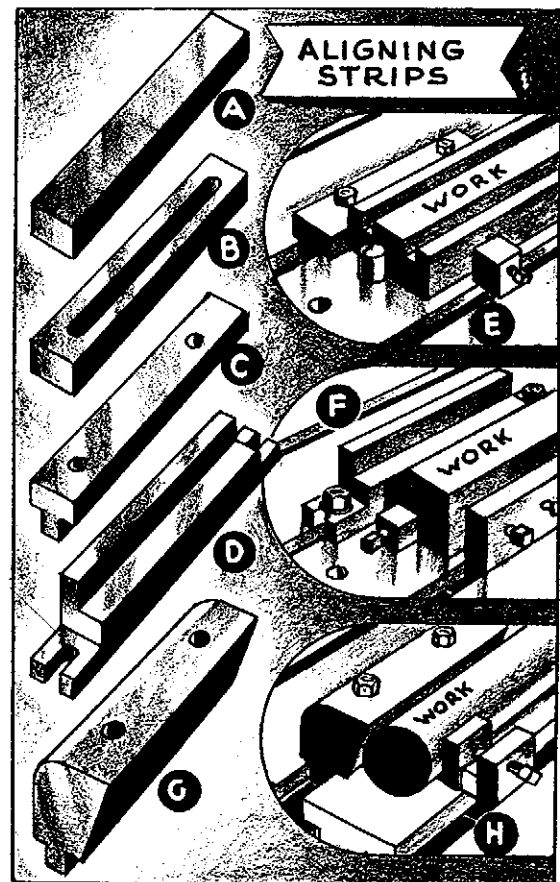

FIG. 112

allel with the direction of the cut. In addition, the tongues prevent the strips from shifting. The aligning strip shown at F may be reversed so that the high side of the strip also can be placed against the work.

To locate and align round shafting on the shaper table, the angular aligning strip shown at G is sometimes used. The strip is aligned parallel with the direction of the cut by placing the tongue of the strip in the table slot H. Bolts secure the strip to the table. The sloping face of the aligning bar is made so that it will form an angle of about 80° with the top of the table. When the round shaft is forced against the bar by the screws of the stops, the shaft will in turn be forced downwards by the slope of the bar. A binding piece is inserted between the screw and the shaft to protect the shaft from the end of the screw and to present a flat surface for the point of contact. As the center of the screw is above the center of the shaft, the packing block is placed at the bottom of the binding piece.

V-BLOCKS

In addition to the method of placing shafts and round pieces directly on the shaper table, round work may be held in rectangular blocks with 90° V-shaped openings cut in one or more of their sides. Shafts are usually many times longer in proportion to their diameters, and for this reason two blocks are ordinarily used to support the work. As the openings resemble a V, they are called V-blocks (Fig. 113).

Although styles of V-blocks vary considerably, probably the two most practical styles are those illustrated at A and B. The one illustrated at A has a flange on the base, the ledge of which is used to support the point of the clamps when the block is clamped to the shaper table. On the underside of the block is a rectangular groove which is cut the entire length of the V-block and into which square blocks, or tongues, are inserted and held in place with screws. The tongues project below the undersurface of the V-block so that when it is placed on the table the tongues fit into the table slot and align the V-block parallel with the direction of the cut. Although this is an advantage, it limits the position of the V-block to placing it central with the table slots. Because of the spacing of the slots on the table, frequently the clamping bolts cannot be placed near enough to the work that they are intended to clamp.

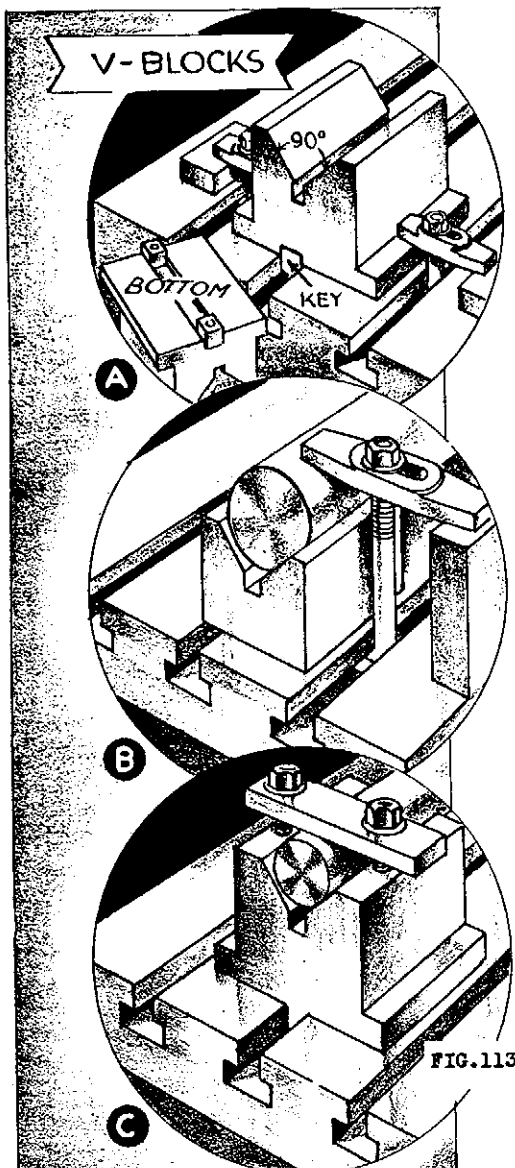

For this reason the tongues can be removed from the underside of the V-block so that they can be placed nearer to the clamping bolts. Although it is a simple matter to remove the tongue, nevertheless it saves time to have available V-blocks without tongues, as illustrated at B. With this style, the flange also has been omitted so that the V-block can be placed as close to the clamping bolt as possible. Time and care, however, are required to align, or set, this style of V-block in the desired position.

Occasionally, special V-blocks such as those illustrated at C can be used. This type of V-block has the advantage of having tongues so that it can be aligned quickly and accurately with the direction of the stroke. It also is provided with flanges which permit it to be clamped to the table. In addition, it carries its own clamping device to hold the work in position and thus eliminates the necessity of shifting the V-block so that the clamping bolts can be placed near the work.

ANGLE PLATE

Work and odd-shaped castings which must be held at right angles to a finished surface can be held by clamping the finished surface to an L-shaped device called an angle plate (Fig. 114). These angle plates are made either of steel or cast iron and are accurately machined to an angle of 90° . Usually angle plates for shapers are made of cast iron with a rib in the center to support the two adjoining sides and with elongated holes through which bolts pass to hold the work to the angle plate and to bolt the angle plate to the table.

On the underside of the base of the angle plate B are cut two rectangular slots at 90° to each other. Into these slots tongues or keys may be fitted and held in position with screws. The tongues may be placed in either one of the slots, depending on whether the angle plate is to be placed parallel or at 90° with the direction of the cut.

The bolt slots in the base are cut parallel with the length of the angle plate so that when the tongues are located in the T-slot, as illustrated at A, the holes will extend over to the adjacent T-slots.

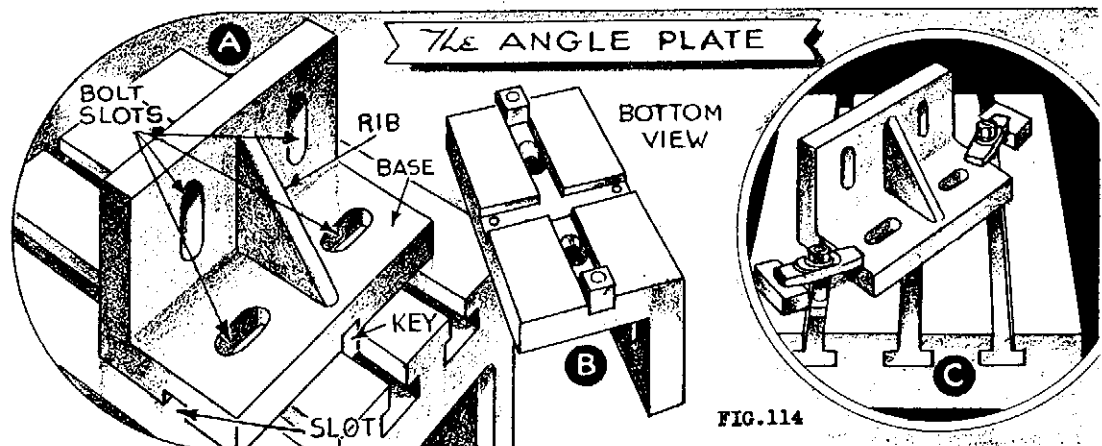

Whenever it is necessary to set the angle plate on the shaper table

at an angle with the direction of the cut, the tongues may be removed entirely from the rectangular slots. To avoid the necessity, therefore, of changing and removing the keys, an angle plate, C, with a plain base may be used. Also, because of the position of the angle plate on the table, it may not be possible to use the bolt holes in the base, for in order that the bolts may pass through the angle-plate slots, they must coincide with the table slots. If this should be the case, the angle plate must be fastened to the table with clamps. Stops also may be necessary to prevent the plate from shifting. Often, however, by rearranging the setup or by shifting the angle plate slightly on the table, one of the bolts may be utilized to hold one side of the plate and clamps may be used to secure the remaining portion. Furthermore, bolts which pass through slots or bolt holes have a greater gripping power because of their direct gripping action as compared with the lever action of the clamp, and should be used whenever practical when two surfaces are being clamped together.

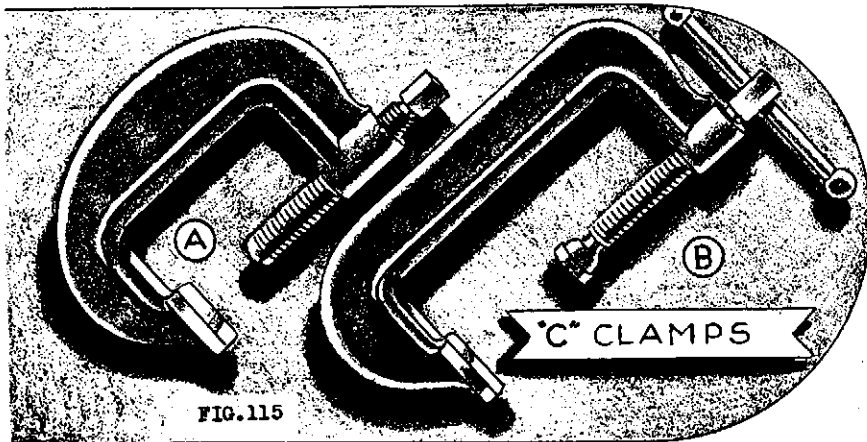

C-CLAMPS

There are times when clamps and bolts cannot conveniently be employed to hold parts together, and for this reason other clamping devices have been designed which may be substituted. One of these devices is the C-clamp illustrated in Fig. 115. As the name implies, it is shaped like the letter C. The clamp should be made of tough steel and heat

treated after forging to increase its strength and to reduce any tendency to spring. The parts to be held together are clamped between the pad and the end of the screw, and when pressure is applied by turning the screw, the pieces are held tightly together.

The C-clamp illustrated at A is a heavy-duty clamp with a plain screw and, consequently, unless some means is used to protect the surface being clamped, the end of the screw will mar the surface. This may or may not be objectionable. To overcome this, the screw in clamp B is provided with a swiveled end so that when the end of the screw makes contact with the work it stops rotating but allows the screw to continue to turn and apply additional pressure. Added protection for the surface being clamped may be obtained by placing a piece of soft metal or cardboard under the swiveled end of the screw and another piece on the pad of the clamp. The swiveled end of the screw has an additional feature in that it allows the swiveled end of the screw to align itself against a tapered or an irregular surface.

The styles of clamps vary considerably. For light clamping pur-

poses, the one illustrated at B can be used, whereas for use when considerable clamping pressure is required, the heavy-duty clamp illustrated at A is preferable. Special styles may be purchased as desired.

When the size of the clamp is being designated, the distance between the end of the screw and the pad of a fully opened C-clamp is called the capacity; the distance from the center of the screw to the inside edge of the C-clamp is termed the throat. Ordinarily, C-clamps are made with narrow throats because there is less strain on the clamp when the distance from the screw to the back of the clamp is short. Should it be necessary that the screw applying the clamping pressure be at some distance from the edge of the clamped surface, then a C-clamp with a deep throat must be used. C-clamps are quickly and easily adjusted, and are convenient and handy when used in the correct situation.

MACHINIST'S CLAMPS

Another style of clamp that is used considerably is the machinist's, or parallel, clamp (Fig. 116). This clamp is especially suitable when the pieces to be held together are parallel and have a machined finish.

The machinist's clamp consists of two screws and two jaws which embody the same principle of gripping as do the clamps and the bolts (Fig. 199) with the exception that the machinist's clamp is self-contained and needs no additional support. Screw C takes the place of the supporting block in Fig. 199 and can be adjusted to suit the width of the surfaces to be clamped; and, similarly, screw D is substituted for the clamping bolt which is used to apply the clamping pressure. The shoulder of the center screw D has been made convex to rest on a concave seat which is cut in the outer side of the jaw A. This construction allows the jaws to tilt slightly. The end of the screw C is turned down to fit loosely into a blind hole that is drilled in the face of the jaw and toward the end.

The jaws are made of tough, drop-forged steel, and, together with the screws, are heat treated to increase their strength. Both holes in the jaw B are threaded; the holes in the jaw A are plain. When the clamp is adjusted properly, it holds very securely, and if a strip of soft metal or cardboard is placed between the jaws and the clamped surface, the jaws of the clamp will not mar the work. The machinist's clamp is light, handy, and convenient, but not particularly powerful.

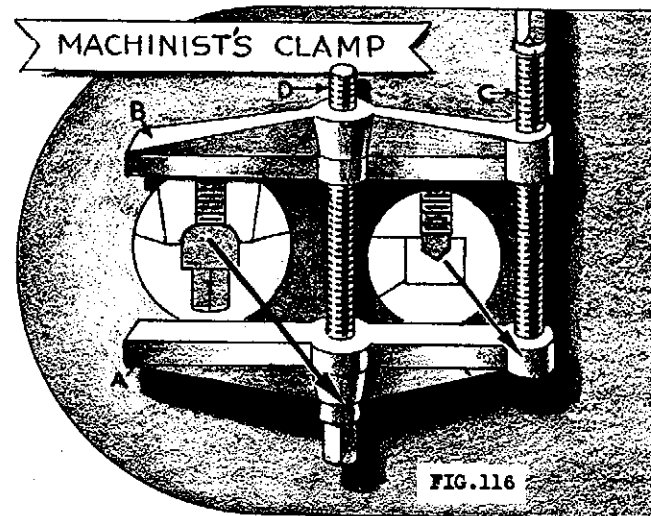

JACKS

JACKS

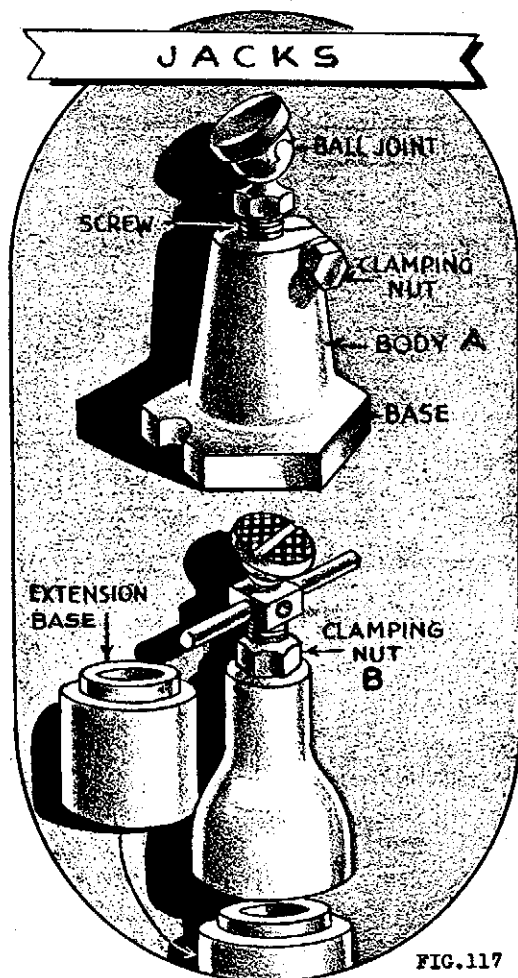

FIG. 117

In spite of all the clamping devices and methods of holding work on the shaper table, it is not always possible to level work or to support overhanging pieces properly without the aid of a jack (Fig. 117). A jack can be easily slipped under the work, the screw adjusted to the height of the supported surface, and then the screw locked in position so that it does not jar loose.

The body of the jack A is threaded to receive the screw which may be raised or lowered by turning. The screw has a ball joint at the top which allows the end to swivel and to bear evenly against the surface of the work.

Without some form of locking device, the screw of the jack would be jarred loose by the vibration of the machine. To overcome this, the body of the jack is split at the upper end so that when the clamping nut is tightened the threaded portion of the screw is gripped and held securely. This, however, is not the only type of locking device. Sometimes an extra nut is placed on the screw near the top of the jack as illustrated at B. After the top of the screw has been set to the

height of the supported surface, this extra nut is given a partial turn clockwise. Thus the screw is locked tightly by being drawn against the thread in the body of the jack.

Jacks are made in various sizes to accommodate different heights of work. If a jack is not high enough to reach the work, a small jack may be placed on a block, or an extension base may be used.

When a bolt and clamp are used to hold an overhanging surface, a jack placed underneath the work makes a very suitable support. Jacks, then, are a very convenient means of leveling, bracing, and supporting work. A set of them should always be available, especially when a large variety of work must be set up on the shaper table.

SHIMS AND WEDGES

Whenever a rough casting or uneven work is secured directly to the shaper table, the uneven surfaces must be supported to prevent rocking. It is especially important to have a solid foundation under

the part to be clamped. This support will prevent any spring or distortion due to the pressure of the clamps. As these spaces are usually small, thin strips of metal, wood, cardboard, or paper, called shims, are used as packing.

Sometimes it is more practical to use a wedge, which is a piece of steel thinner at one end than at the other. The thin end of the wedge can be inserted into the space and then tapped slightly to make a solid base. When work must be leveled on the table, the wedge is often preferable because the low spot can be easily raised by inserting a wedge at the proper place and tapping or driving it in as may be required. Although wedges and shims can be made of almost any material, they are usually made of metal.

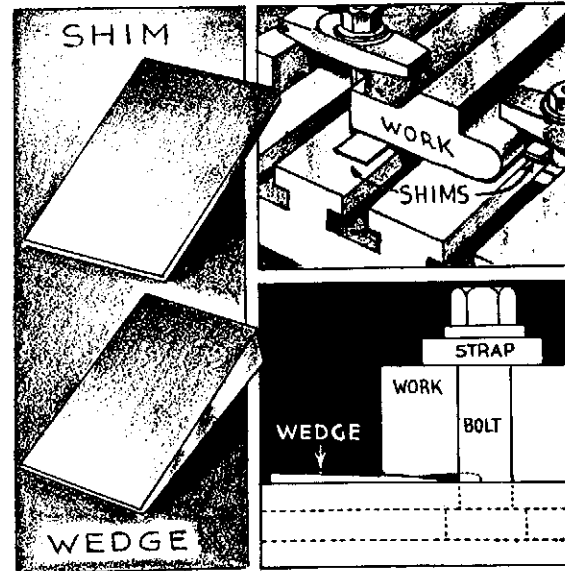

FIG.118

PACKING AND STEP BLOCKS

Square or rectangular blocks are used to support straps, or clamps, at the end opposite the work. As the clamp must be level to obtain maximum gripping power, blocks are made in various sizes so that they can be used singly or in combination and in such a manner that the height of the supporting surface corresponds to that of the work. Usually packing blocks are made of metal; however, wood blocks are often substituted.

To suit the various heights to which the end of the clamp must be supported, the step block with its series of raised surfaces is an exceedingly handy piece of equipment. Although it is difficult, in all cases, to foretell at what height the clamp must be supported, nevertheless, the slight variation between the height of the selected step and the height of the work can be eliminated by putting a thin packing strip between the clamp and the step to be used.

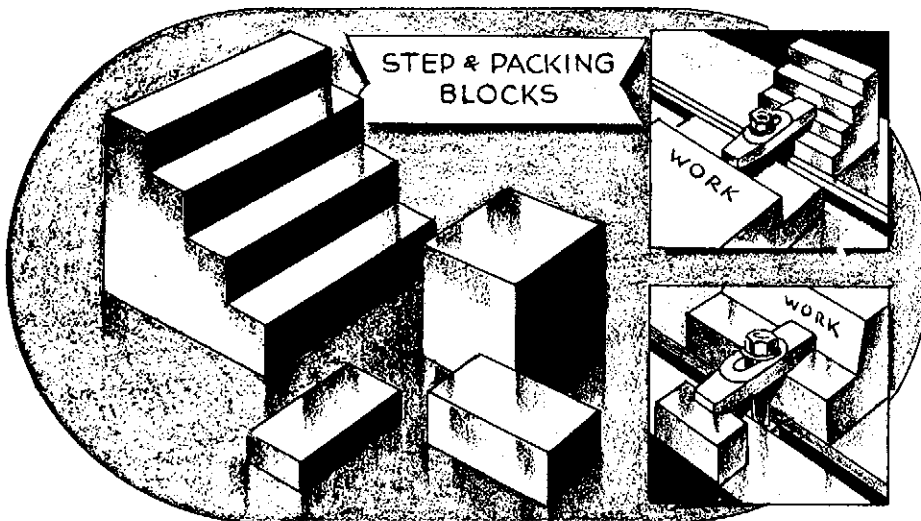

FIG.119

FIXTURES

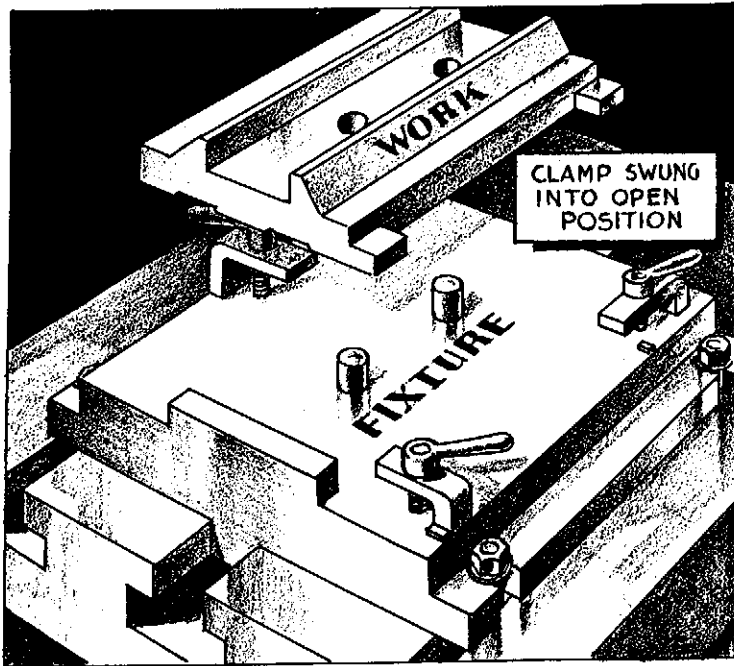

FIG. 120

A fixture (Fig. 120) is a special device designed to hold irregularly shaped jobs which cannot be held by the usual methods and to hold pieces which are required in large quantities.

Both the fixture and the tool are moved during shaper-machining operations and for this reason a fixture for shaper work is used principally as a holding device. The larger fixtures are usually fastened to the table; the smaller ones are often held in the vise.

A good fixture is made so that the work is located accurately, secured quickly and firmly, and released easily.

Whether or not a fixture should be used depends upon many factors. If there are a large number of pieces to be made and if the cost per piece can be reduced by using a fixture, one may be justified. Odd-shaped pieces that are awkward to handle and require considerable time to set up may often be easily and quickly clamped in a fixture. On the other hand, to make a fixture for one or two pieces, even if the pieces are difficult to hold by the usual methods, does not, as a rule, warrant the cost.

SPECIAL VISE JAWS

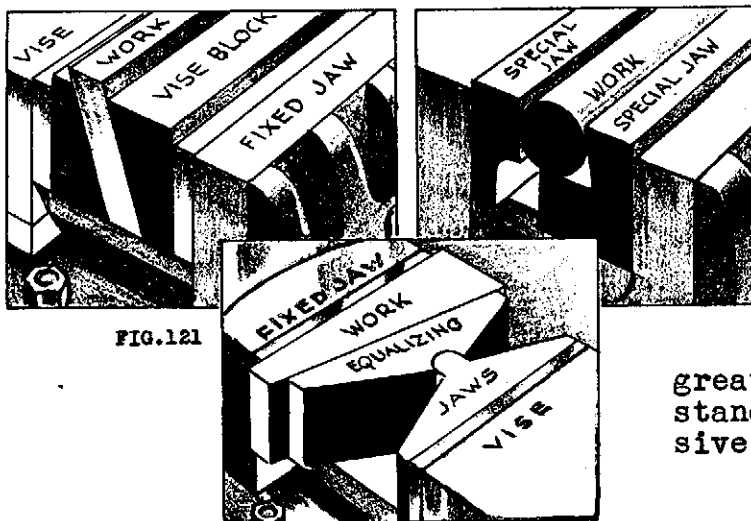

FIG. 121

Special vise jaws and shaped vise blocks, although not ordinarily classified as fixtures, have a great many possibilities for holding work which would be difficult to hold in any other way. Only three simple examples are given in Fig. 121, but it should be remembered that these types of holding devices have a great many adaptations and in many instances can be used instead of expensive fixtures.

HOW TO MOUNT WORK-HOLDING DEVICES

Unit 1-P52(B) Pages 117 to 150



Photo by courtesy of Cincinnati Shaper Co.

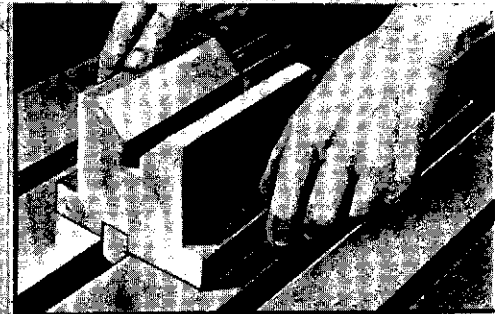

MOUNTING V-BLOCKS

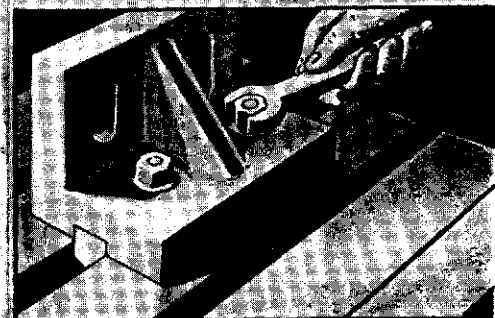

MOUNTING ANGLE-PLATE

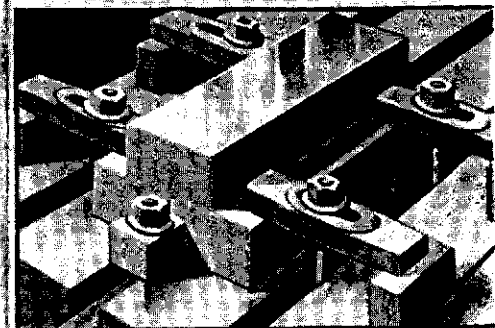

MOUNTING WORK ON TABLE

UNIVERSITY OF THE STATE OF NEW YORK
STATE EDUCATION DEPARTMENT
BUREAU OF INDUSTRIAL AND TECHNICAL EDUCATION

HOW TO MOUNT WORK-HOLDING DEVICES

OBJECTIVES OF UNIT

1. To explain how to mount and dismount the shaper vise.
2. To explain how to set the vise parallel, at 90°, and at an angle with the direction of the stroke.
3. To explain how to use other work-holding devices.

INTRODUCTORY INFORMATION

The student will find it much easier to select the most suitable type of holding device if he has read the description of work-holding devices given in the preceding section. Of all the work-holding devices, the vise is the most extensively used. It is heavy and awkward to handle, however, and for this reason it should not be taken off the table unless some other method is to be used to hold the work. If more than one shaper is available and if the shapers are being used for a variety of work, it is sometimes convenient to keep one shaper for vise work, thereby saving the time and labor required to mount and dismount the vise on the table.

In addition to vises, there are many types of holding devices ranging from the simple clamp to more specialized devices designed to meet the requirements of a special piece of work. Although the devices illustrated in this section are of standard design, the experienced operator may often be able to suggest slight modifications which would save considerable time and labor when the job is being set up.

Finally, it is important that all work-holding devices be carefully and properly stored when not in use. Proper storage of the parts to prevent damage and proper cleaning and oiling to prevent rust and to insure smooth operation, are some of the essential routine duties of the good mechanic.

TOOLS AND EQUIPMENT

Shaper
Parallels
C-clamps
Stops
Toe Dogs
Hold-downs
V-blocks
Jack
Fixtures
Brush

Necessary Wrenches
Slot Cleaner
Lead Mallet
Cleaning Cloth
T-head Bolts
Magnifying Glass
Shaper Vise
Assorted Clamps
Machinist's Clamps
Aligning Strips

Angle Plate
Mill File
Packing Strips
Step Blocks
Wedges & Shims
Special Vise Jaws
Square & Protractor
Tissue Paper
Indicator
Oil Can

HOW TO MOUNT A SHAPER VISE WITH A DETACHED BASE
ON THE SHAPER TABLE

PROCEDURE

1. Read the description of the vise illustrated on page 99, Fig. 89, and note that the base is separate from the vise body and that three bolts are used to hold the vise and the base to the shaper table.
2. First, thoroughly clean the table.
3. Draw the slot cleaner (Fig. 122) through the entire length of the table so that all dirt and chips are removed.
4. Use a brush to brush off the chips from the table top before and after cleaning the chips from the slots.
5. Wipe the table top with a clean cloth.
6. Inspect the surface of the table for burrs. If burrs are present, remove them with a file. Use care when burrs are being removed so that the table is not damaged by excessively filing or scraping the surface.
7. Clean thoroughly the base of the vise, being sure that all chips are removed from the slots to prevent them from getting between the underside of the base and the table top (Fig. 123).
8. Place the base on the table with the graduations toward the front (Fig. 123).
9. Align the key attached to the base with the key slot in the table and lower the base.
10. Clean thoroughly the body and the base of the vise (Fig. 124).

NOTE: If preferred, a bar can be tightly held between the vise jaws so that this end of the vise can be held securely when it is being lowered onto the base.

CAUTION

Three persons are required to mount the vise on the base.



FIG.122

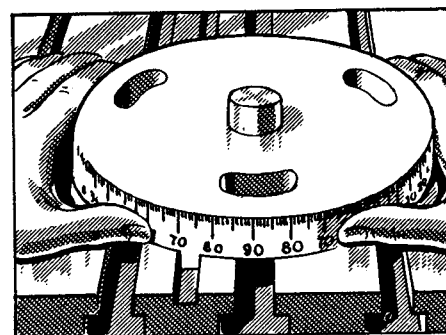

FIG.123

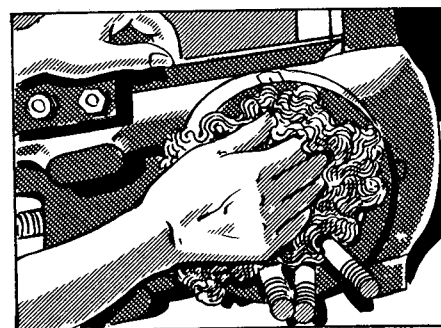

FIG.124

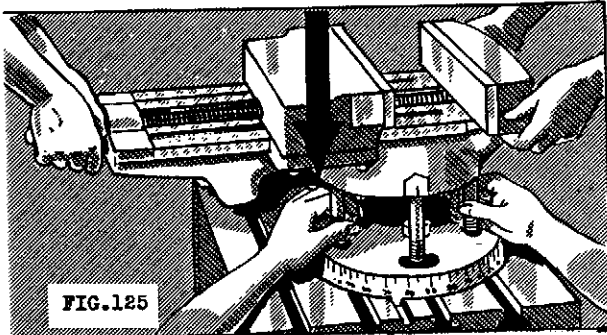

FIG. 125

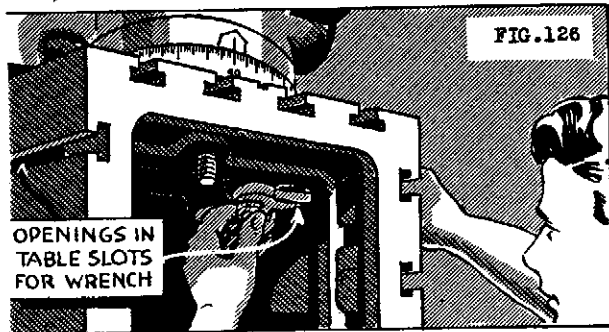

FIG. 126

OPENINGS IN
TABLE SLOTS
FOR WRENCH

11. Have two persons hold the body of the vise above the base and the third person place the bolts around the T-slot so that they coincide with the slots in the base (Figs. 125 and 133).

12. Lower the vise carefully to the base when the person arranging the bolts gives the signal. Be sure that the pilot upon which the vise swings enters the recess in the vise body.

CAUTION Arrange the bolts approximately in position before lowering the vise. The final adjustments must then be made with a rod. Under no circumstances must the fingers be placed between the vise and the base at this time.

13. Place a washer and a nut on each of the three bolts which protrudes through the table, and screw the nuts on just far enough to hold the vise and the base to the table.

14. Rotate the vise until the zero mark on the vise coincides with the desired graduation on the base, and tighten the nuts securely.

HOW TO MOUNT A SHAPER VISE WITH A CLAMP-RING BASE

1. Read the description of the vise illustrated on page 100, Fig. 91, and note that the base acts as a clamping ring. In the illustration the base is shown separated from the vise in order to make clear the construction and method of clamping; however, the base is not removed when the vise is mounted on or taken off the table.

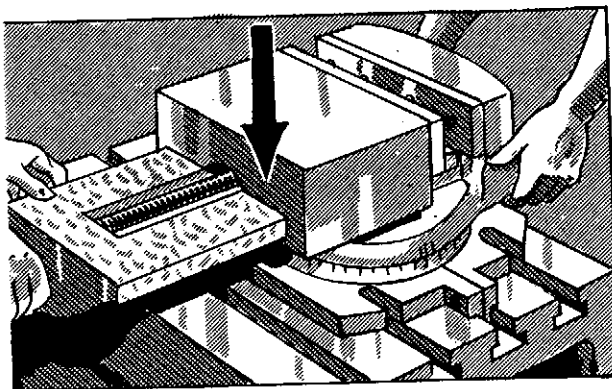

FIG. 127

2. First, thoroughly clean the table and the base of the vise, following the procedure given on page 119, instructions Nos. 3 to 7 inclusive.

3. Place the vise, with base attached, on the table with the graduations toward the front (Fig. 127).

4. Align the key attached to the base with the selected T-slot, which is usually the second from the right on the operator's side, and lower the base and the vise to the table.

5. Place a bolt in each end of the two table slots which correspond to the bolt slots in the base of the vise. Be sure that the two back bolts can be placed in the table slots after the base is placed on the table.
6. Move the bolts along to enter the slots in the vise base.
7. Place a washer and a nut on each of the bolts and screw them on just far enough to hold the vise in place.

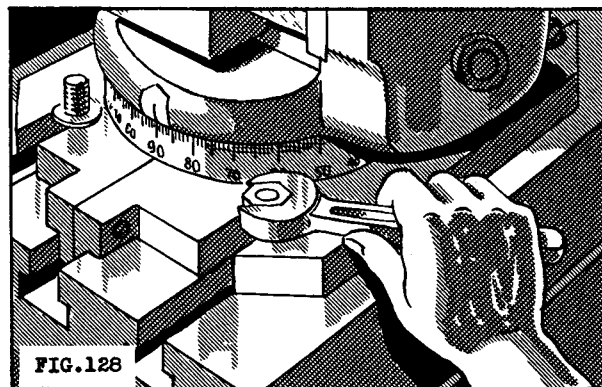

8. Move the vise around to the desired position and tighten the four bolts. The vise and the base will then be secured to the table and will not shift under the heaviest of cuts.

HOW TO MOUNT A SHAPER VISE WITH
AN INDEPENDENT BASE

1. Read the description of the vise illustrated on page 100, Fig. 92, and note that the base is clamped to the table independently of the vise. The base is not detached, though, when the vise is mounted on or taken off the table.
2. First, thoroughly clean the table. (Follow the procedure given on page 119, instructions Nos. 3 to 7 inclusive.)
3. Place the bolts in the table slots before lowering the vise to the table if the base has bolt holes instead of slots. If the base has slots instead of bolt holes, the bolts may be moved into place afterwards.
4. Allow the bolts to enter the bolt holes in the base; then lower the vise and the base to the table.
5. Place a washer and a nut on each bolt and tighten the four nuts. These will hold the base to the table.
6. Rotate the vise until the zero mark on the vise coincides with the desired graduation on the base.
7. Tighten the four nuts on the vise. These will secure the vise in position on the base (Fig. 131).

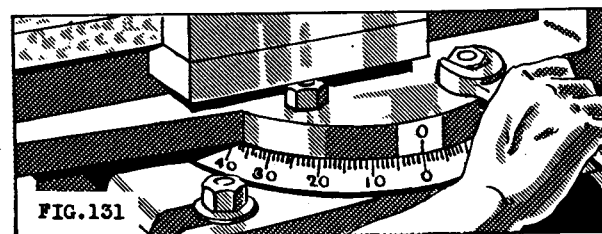
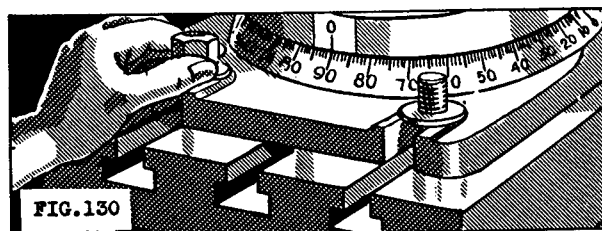
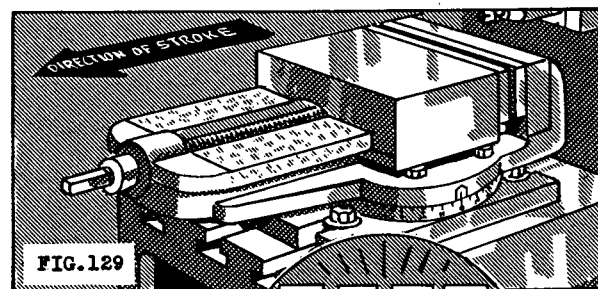



HOW TO DISMOUNT A SHAPER VISE WITH A
DETACHED BASE FROM THE SHAPER TABLE

1. Clean off all chips from the vise and the table with a brush.
2. Loosen and take off the three nuts and washers from the clamping bolts which pass through the table and project from the underside.

NOTE: A bar can be gripped between the vise jaws in order to provide handles for lifting the vise more conveniently (Fig. 133).

3. Lift the vise so that the bolts clear the base, and place it on a bench or a suitable tool stand.
4. Remove the base from the table.
5. Clean around the vise screw and other parts that were inaccessible before the vise was taken off the table.
6. Wipe the parts with an oily cloth to prevent rusting.
7. Assemble the vise and the base and put the nuts and washers on the bolts.
8. Place the vise on a stand near the machine or store it in an appropriate and safe place to prevent damage or injury to the surface of the jaws or to other parts of the vise.



FIG. 132

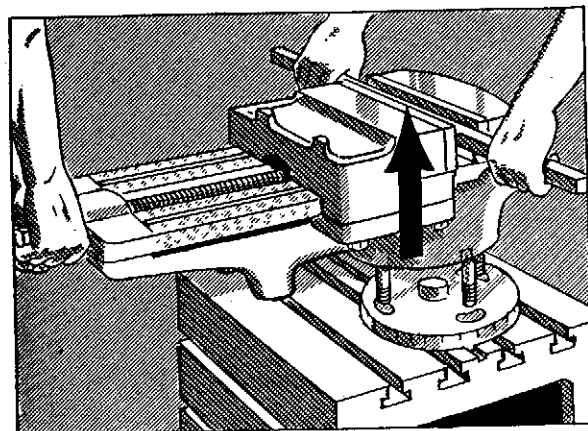

FIG. 133

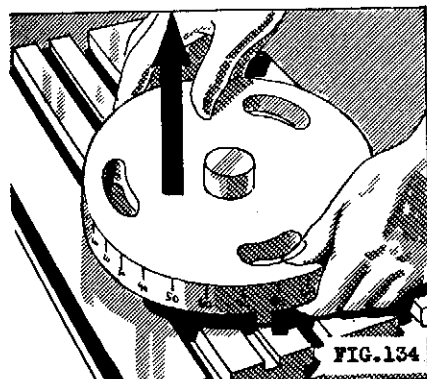

FIG. 134

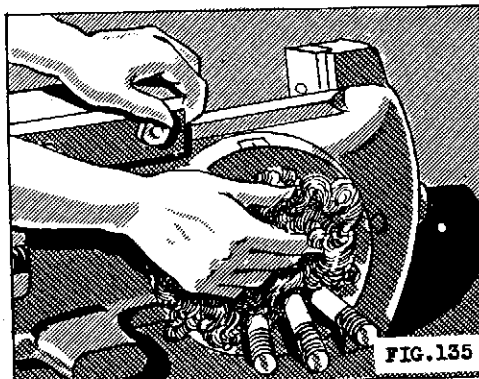

FIG. 135

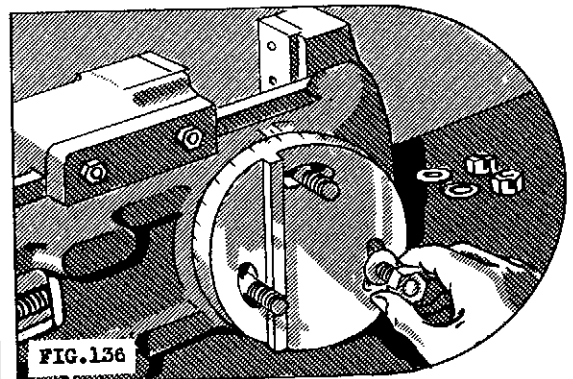

FIG. 136

HOW TO DISMOUNT A SHAPER VISE
WITH AN ATTACHED BASE

Although some vises have detachable bases, other vises are attached to the base with a clamp ring (page 100) or with four T-head bolts, which are held in a circular T-slot in the base (page 100). In each case, the vise is not removed from its base when it is being mounted on or taken off the shaper table.

1. Clean off all chips from the vise and the table with a brush.
2. Wipe the vise with a cloth. If a coolant has been used, the vise should be dried with waste or rags.
3. Remove the four nuts which hold the base to the table (Fig. 137).
4. Lift the vise with the base attached, remove it from the table, and place it on a bench or a tool stand large enough to hold the vise (Fig. 138).
5. Clean around the vise screw and other parts that were inaccessible before the vise was taken off the table.
6. Wipe the parts with an oily cloth to prevent rusting.
7. Place the vise on a stand near the machine, or store the vise in an appropriate and safe place to prevent injury to the surface of the jaws or to the other parts of the vise.
8. Remove and clean the T-bolts and place them, with nuts and washers replaced, with the vise.

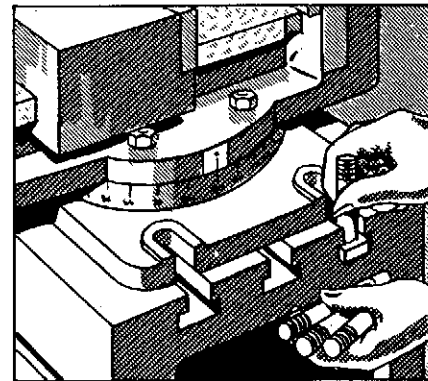
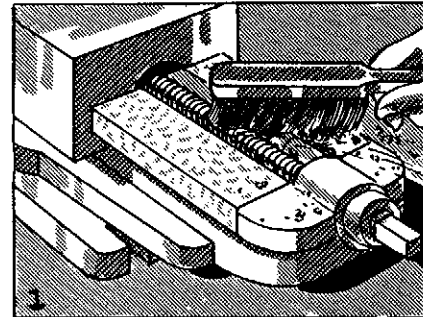
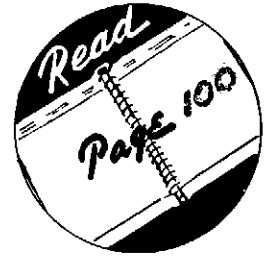

FIG. 137

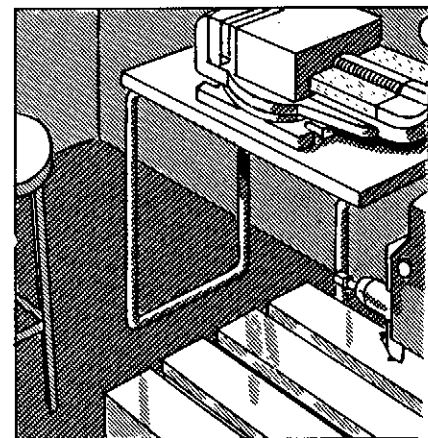
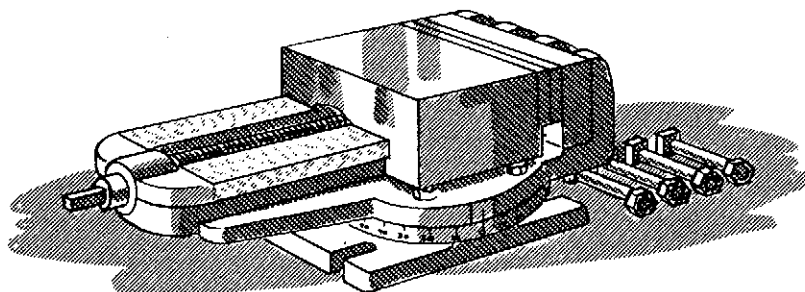

FIG. 138

HOW TO SET THE SHAPER VISE WITH THE AID OF THE
GRADUATIONS ON THE BASE

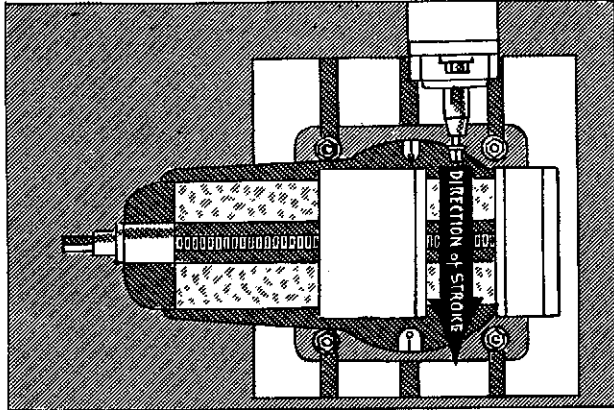

FIG. 139

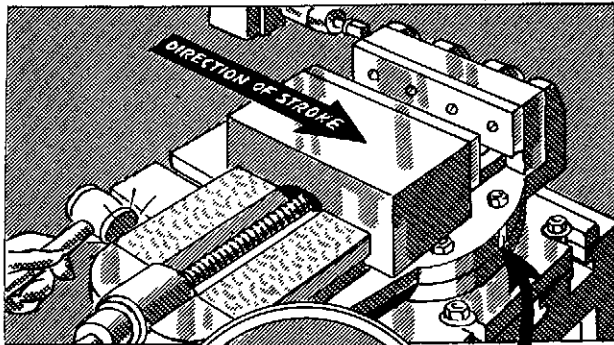

FIG. 140

PARALLEL WITH THE DIRECTION OF THE STROKE

1. Loosen the clamping nuts on the bolts just enough so that the vise will swivel on the base.
2. Note whether the bolts hold the vise independently to the base or whether the vise and the base are clamped to the table as a unit. (Refer to pages 99 to 100.)
3. Set the zero mark on the vise with the 90° graduation on the base.
4. Tighten the nuts on the clamping bolts just enough to hold the vise in place.
5. Lightly tap the vise into position with a lead mallet if it is necessary to adjust the setting. Use a magnifying glass to magnify any slight variation in the position of the matching lines, thereby making it possible to adjust the markings more accurately (Fig. 140).
6. Securely tighten the clamping nuts after the vise has been finally checked and set.

AT RIGHT ANGLES (90°) TO
THE DIRECTION OF THE CUT

1. Loosen the clamping bolts.
2. Move the vise around until the handle of the vise is toward the front and the two zero marks on the vise coincide with the zero graduations on both sides of the base.
3. Tighten the nuts on the clamping bolts just enough to hold the vise in position.
4. Examine the setting, and, if an adjustment must be made, tap the vise into position with a lead mallet.

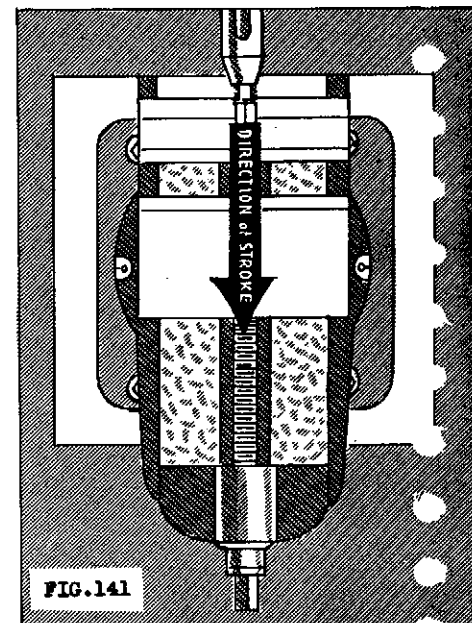

FIG. 141

5. Preferably, use a magnifying glass when the setting is being checked.
6. Tighten the clamping nuts securely after the vise has been finally checked and set.

AT AN ANGLE TO THE DIRECTION OF THE STROKE

1. Read both the instructions given on page 231 for determining the angle at which the vise must be set and also the directions given for positioning the vise to correspond with the angular setting.
2. Note that the zero position is the one in which the vise jaws are set 90° to the direction of the stroke (Fig. 142).
3. Loosen the clamping nuts and move the vise around from the zero position until the zero mark on the vise coincides with the desired degree on the base (Fig. 143).
4. Tighten the nuts on the clamping bolts just enough to prevent the vise from moving.
5. Check the setting, and, if it is necessary to make an adjustment, lightly tap the vise into position with a lead mallet. Preferably use a magnifying glass when the setting is being checked.
6. Securely tighten the clamping nuts after the vise has been finally checked and set.

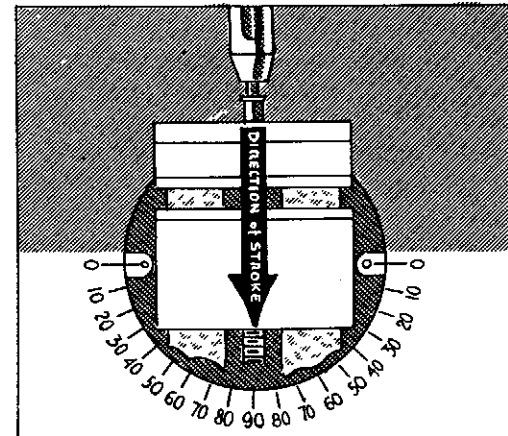

FIG.142

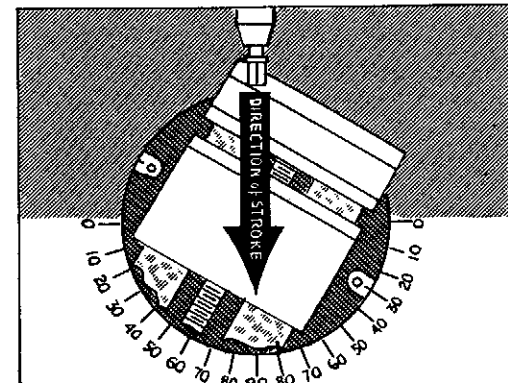

FIG.143

HOW TO SET THE VISE WITH THE AID OF AN INDICATOR

NOTE: The setting of the vise with the graduations on the base is usually accurate enough for most purposes; but when extreme accuracy is essential, other methods must be employed. A very simple and accurate gage for this purpose is the dial indicator, one of which should always be available in a well-equipped machine shop.

These indicators are graduated to read either to one one-thousandth part of an inch ($1/1000''$) or to one ten-thousandth part of an inch ($1/10,000''$),

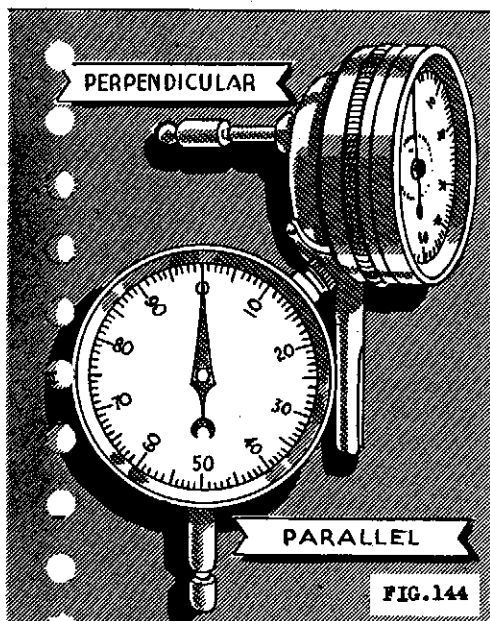

FIG.144

the operator estimating the value when the pointer is not exactly on the line representing the basic dimension. Four procedures for setting the vise with the aid of an indicator are given in the following pages.

HOW TO SET THE BOTTOM OF THE VISE PARALLEL
WITH THE TABLE WITH AN INDICATOR

1. Follow the procedure given on pages 119 to 122 if the vise is not mounted on the table, selecting the procedure to suit the style of vise.

CAUTION Be sure that dirt does not get between the vise and the table surfaces because a very small particle between the surfaces will interfere with the parallelism of the vise with the table.

2. Set the vise jaws approximately parallel with the direction of the stroke. (Refer to Fig. 145.)
3. Open the vise to its full capacity.

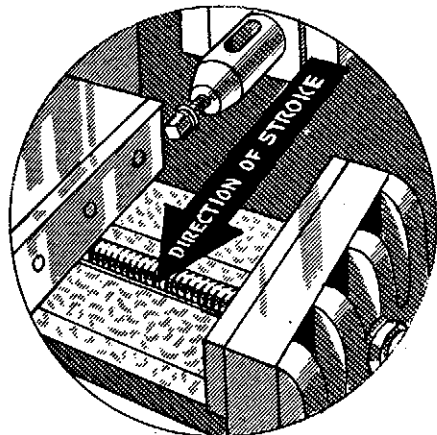

FIG. 145

4. Examine the work seat of the vise for burrs, and carefully remove any that may be present.
5. Thoroughly clean the surface.
6. Select two test parallels high enough to project above the top of the vise jaws and long enough to extend two or three inches beyond the width of the vise (Fig. 146).

NOTE: If parallels are not available, the indicated readings may be taken directly from the work seat of the vise.

7. Thoroughly clean the parallels and lay them carefully on the work surface of the vise.

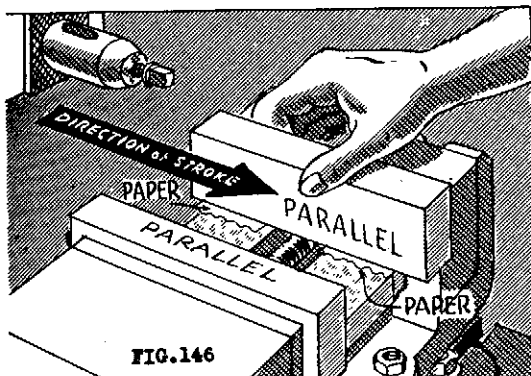

FIG. 146

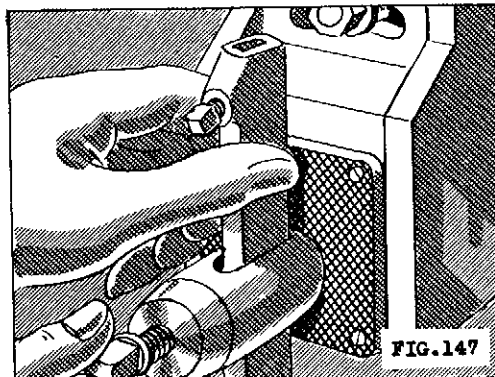

FIG. 147

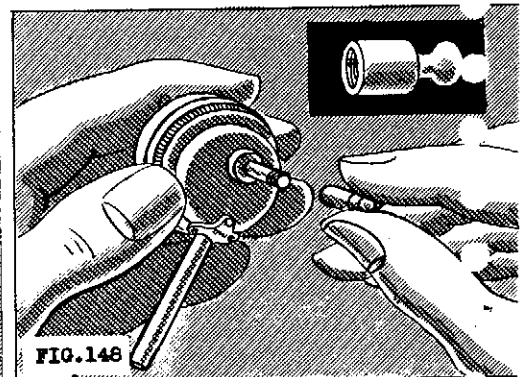

FIG. 148

Place one against each of the vise jaws.

8. Arrange the parallels against the face of the vise jaws so that they both project evenly beyond the sides of the vise. Some mechanics prefer to place a piece of tissue paper under the ends of each parallel to insure good contact and to prevent slipping (Fig. 146).
9. Select an indicator with the contact shaft perpendicular with the dial (Fig. 144). The dial faces upward and can be conveniently read from the operating position.

NOTE: Dial indicators are made with two types of contact shafts, one parallel and the other perpendicular to the face of the dial. Figs. 149 and 152 illustrate the arrangement for both types of indicators.

10. Reverse the position of the tool holder in the tool post. This will provide a more convenient surface upon which to place the clamp because the tool end which contains the set screw and the tool has an irregular surface.
11. Attach a small, ball-type contact point to the end of the indicator contact spindle. This point is simply screwed onto the end of the contact spindle, and, when necessary, can be removed quite easily (Fig. 148).
12. Assemble the indicator, the gage-holding rod, the swivel or sleeve, and the clamp.
13. Clamp the assembled unit to the end of the tool holder with the dial facing upward (Fig. 152).
14. Manipulate the down-feed crank and the cross-feed table control handle until the contact point is about one-half inch above one of the parallels.

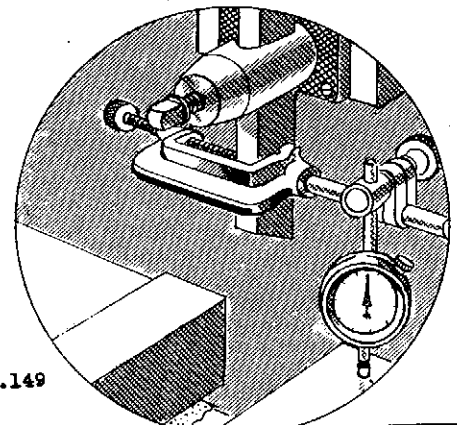

FIG. 149

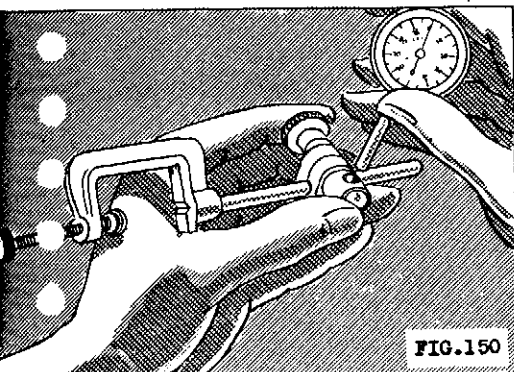

FIG. 150

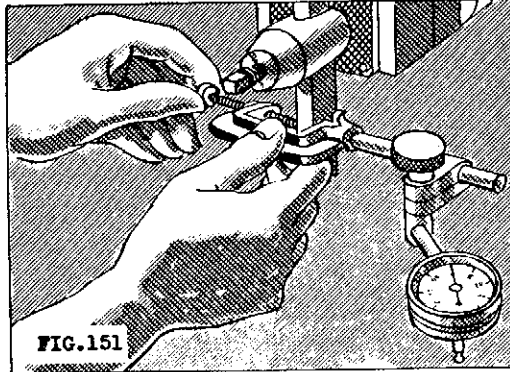

FIG. 151

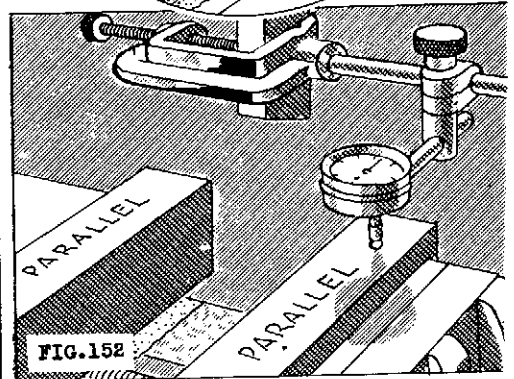
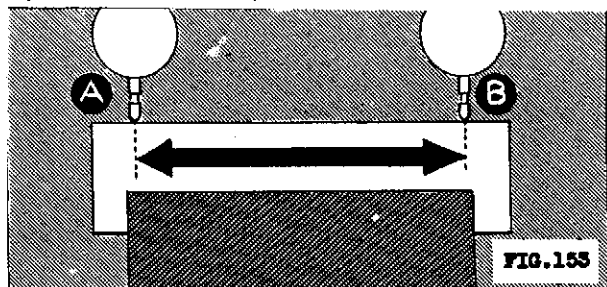

FIG. 152



15. Set the machine so that the length of the stroke is about one inch shorter than the length of the parallels. (Refer to page 79 for adjusting the stroke.)
16. Position the ram so that the contact point travels within one-half inch of both ends of the parallels. (Refer to page 81 for positioning the ram.)

CAUTION If the ram with the attached indicator cannot be operated by hand, use a slow speed to move the indicator back and forth over the parallel. Great care must be exercised that the point of the indicator is not allowed to travel beyond the surface of the parallel. If this should happen, the point would drop below the level of the surface and would damage the indicator when the return stroke is made. This is also the reason for having both parallels project evenly beyond the sides of the vise. (Refer to operation No. 8.) In other words, both parallels must be set in the same relation to the position of the stroke when the testing operation is in progress; otherwise there is the possibility of the indicator traveling beyond the surface of one of them.

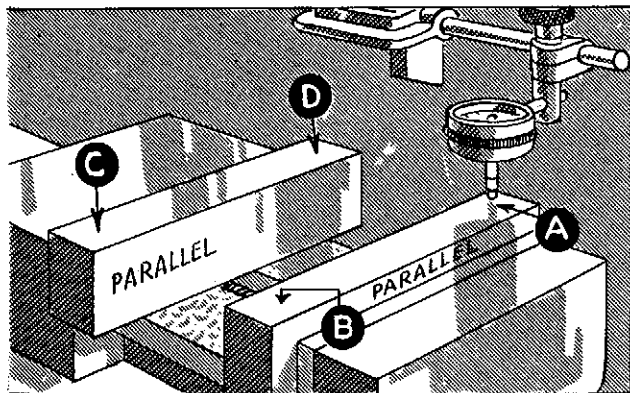

FIG. 154

17. Move the ram so that it is at the beginning of the stroke, and move the table so that one end of the parallel is under the contact point of the indicator as shown at A, Fig. 154.
18. Lower the indicator until the pointer registers about ten one-thousandths of an inch on the dial. This will make certain that the point is making contact with the parallel.

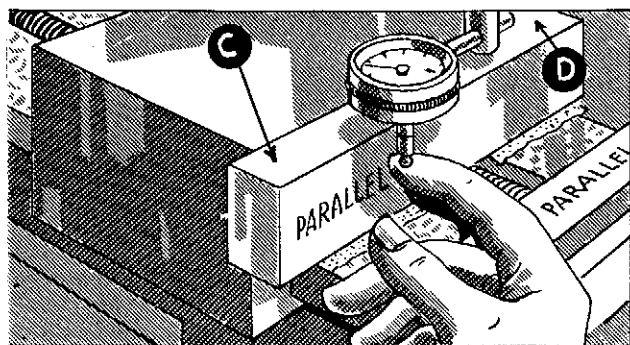
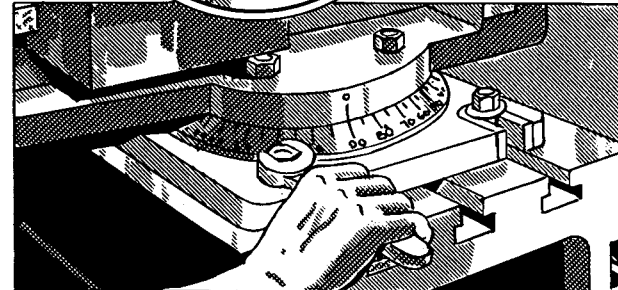
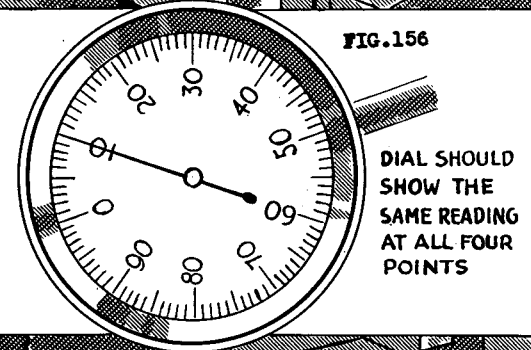
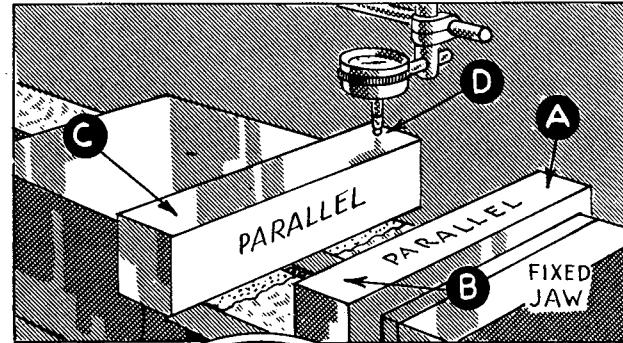

FIG. 155

19. Note the measurement on the dial; then move the ram to the forward position B. If the vise is parallel, the indicator will show the same reading at both ends of the parallel.
20. Bring the surface C of the second parallel under the indicator, raising the contact shaft slightly with the finger as the parallel is moved directly underneath the point of the indicator (Fig. 155).

21. Release the contact shaft and allow the contact point to rest on the parallel. The reading at C should be the same as the readings at A and B.
22. Finally, draw the ram again to the beginning of the stroke. If the reading at D corresponds with all the others, the vise is parallel.
23. If B and C are low, adjust the table support and tighten the table gibs. This may be all that is necessary to bring these points into alignment.
24. If A, B, C, or D is low, loosen the clamping nuts and place a paper shim underneath the lowest point of the base, after making certain, of course, that there are no particles of dirt underneath the base of the vise.
25. Tighten the nuts and recheck the setting at all four points. Follow the instructions given in the preceding operations if further adjustments must be made.



HOW TO TEST THE FIXED JAW FOR SQUARENESS WITH THE AID OF AN INDICATOR

1. Follow the procedure given on page 119 if the vise is not mounted on the table.

CAUTION Be sure that the undersurface of the base and the table surface are clean.

2. Examine the face of the fixed jaw and carefully remove any burrs with a smooth or mill file.
3. Thoroughly clean the vise jaws.

CAUTION Care should be exercised that chips do not get between the jaws of the vise and the work. They may cause injury to the jaws and the work when the vise is tightened. Furthermore, the jaws should be protected from rough work by a strip of soft metal or cardboard placed be-

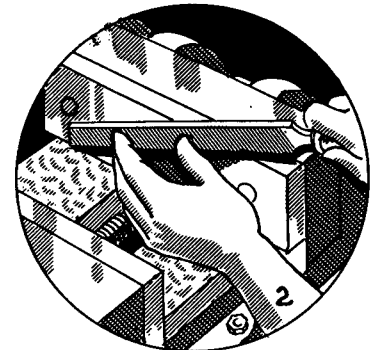

tween the work and the faced surfaces. With proper care the accuracy of the vise can be preserved for an indefinite period of time.

NOTE: Some vises have removable plates attached to the jaws. These plates may be removed by taking out the fillister-head screws. They can then be placed on a machine and the surfaces refaced or reground. This, however, is not usually done, except upon the advice of the instructor or the person responsible for the maintenance of the machine.

4. Place a piece of paper against the fixed jaw of the vise. Next to the paper in a vertical position, place the beam of the square as illustrated in Fig.157.

CAUTION

Try squares are expensive and accurate tools and must be handled with great care if their accuracy is to be preserved. Every precaution should be taken against nicking the surface or the edges; dropping a square may permanently destroy its accuracy, thereby rendering it useless. Squares should be kept in a box or case when not in use.

5. Place a block of clean wood between the beam of the square and the movable jaw; then tighten the vise sufficiently to hold the square in this position.

6. Secure the indicator to the tool holder according to the instructions given on page 127, operations No. 9 to No. 13.

7. Move the ram and the table to bring the blade of the square directly underneath the contact point of the indicator as at A, Fig. 157.

8. Lower the assembled indicator with the down-feed crank until the contact point of the indicator touches the edge of the blade.

9. Continue to lower the indicator until the finger of the dial registers about ten one-thousandths of an inch, assuming that basic dimensions on the dial are in terms of ".001".

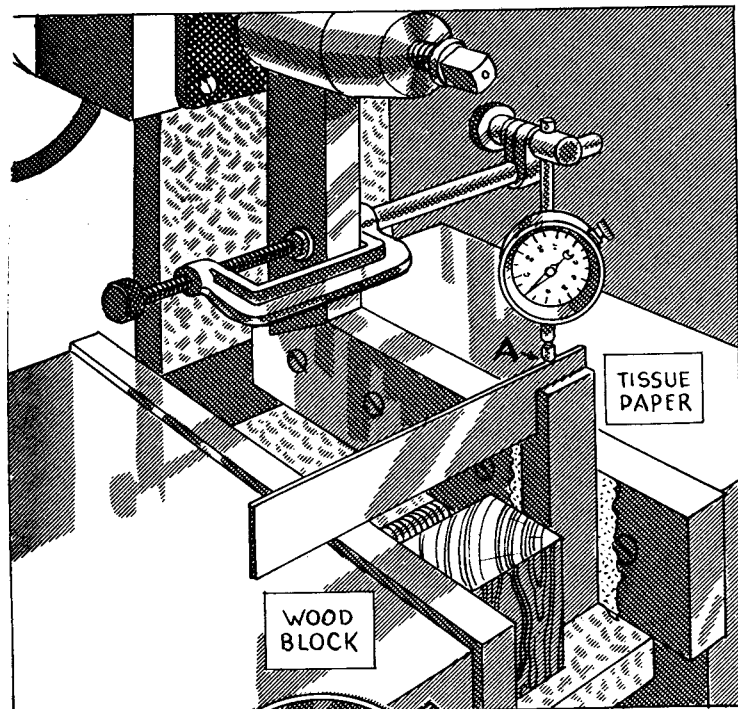
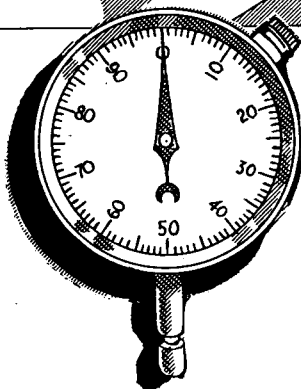
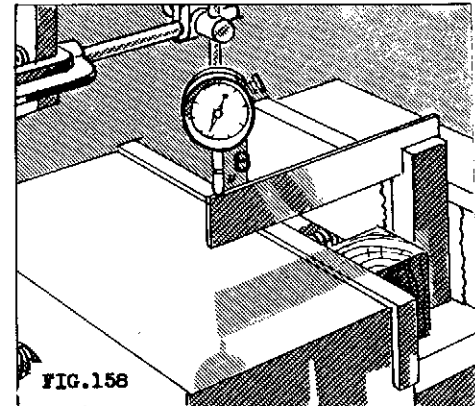

FIG.157



10. Observe the reading and move the table to the right in order to bring the blade of the square under the contact point as at B, Fig. 158.
11. Observe the position of the pointer, and if the readings are the same at both ends of the blade, the face of the fixed jaw is square.
12. Test at each end of the jaw in the same manner.



NOTE: If the pointer does not register the same at both ends of the blade, it will be necessary to shim between the back of the plate and the machined surface of the vise. If the test shows that the face is more than a few thousandths out of square, the plate should be reground because too much shimming may warp the plate when the screws which hold it to the vise are tightened. Consult the instructor about this before taking any action.

13. Observe the difference in the readings indicated at each end of the blade and determine the direction in which the blade must be shimmed to correct the inaccuracy.
14. Estimate the thickness of the shim, realizing that the thickness of the shim should be the same as the error noted on the indicator if the length of the blade and the height of the plate are the same. Similarly, note that the thickness will be only half of the indicated error if the blade is twice as long as the height of the plate.
15. Measure the shim with a micrometer.
16. Remove the square from the vise and carefully place it in a safe place.
17. Take out the fillister-head screws, remove the plate, and clean the machined surface of the vise and the back of the plate. If the reading indicated that the blade is high at B, place the shim between the upper surfaces of the two faces; if it is low at B, place the shim between the lower surfaces.
18. Hold the plate and the shim in place with the hand and insert the fillister-head screws (Fig. 159).

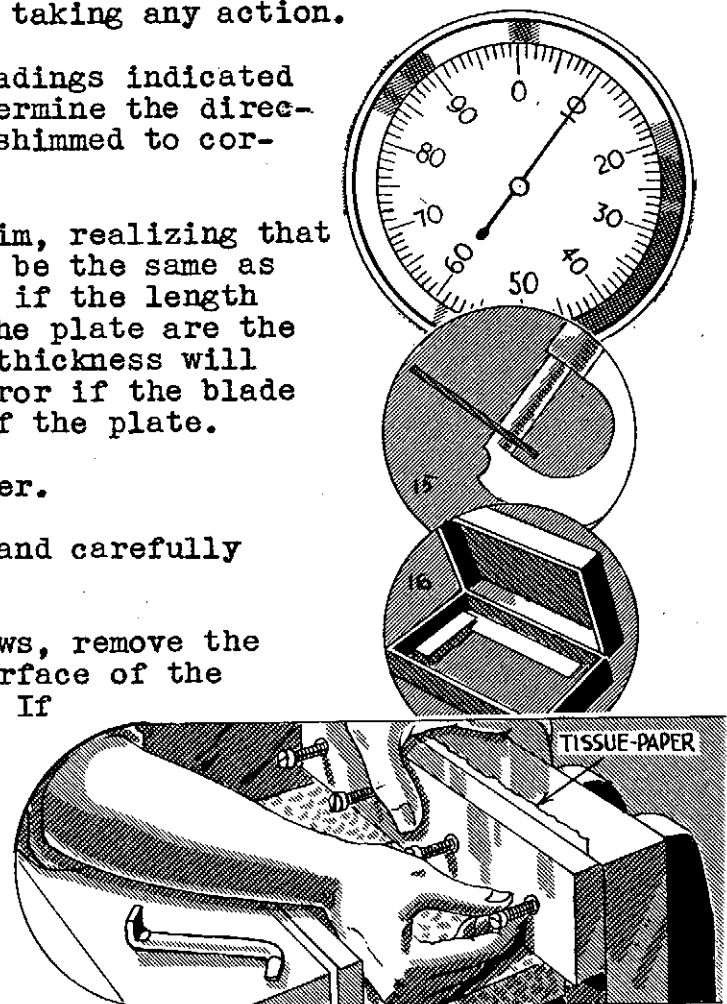

19. Tighten the screws so that the plate is held securely.
20. Again place the square in the vise and repeat the testing procedure until the face of the jaw is square.
21. Remove the indicator from the machine, the square from the vise, and carefully replace them in their boxes.

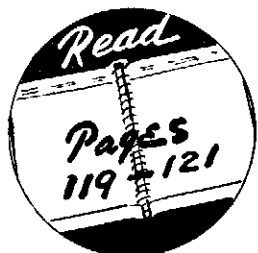

HOW TO SET THE VISE PARALLEL WITH THE DIRECTION OF THE STROKE WITH AN INDICATOR

1. If it is necessary to mount the vise on the shaper table, follow the instructions given on page 119. The vise, however, when not in use, is usually left on the table.

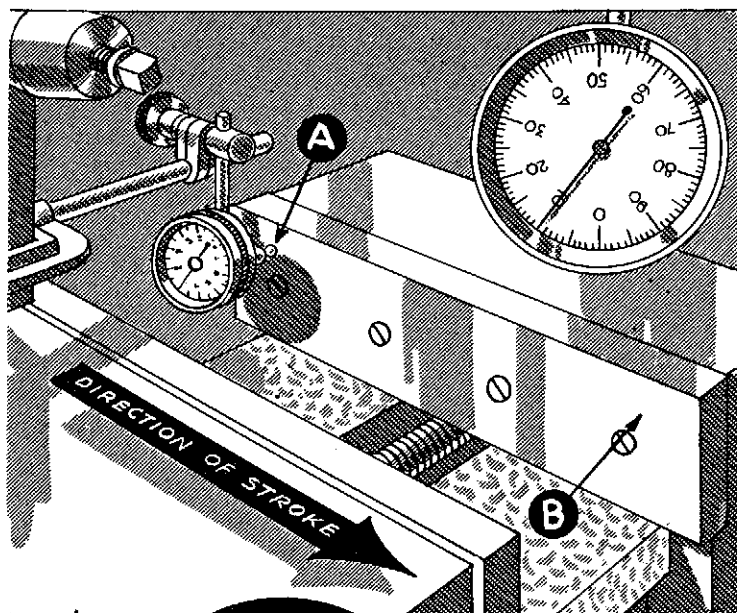
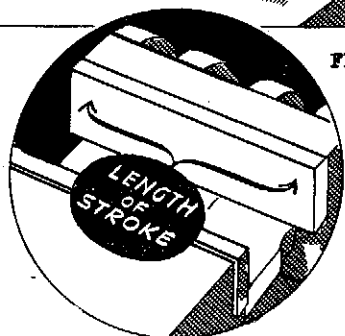

FIG. 160



2. Loosen the clamping nuts and set the vise so that the jaws are parallel with the direction of the cut. The vise handle should be on the left and the zero mark on the vise should coincide with the 90° graduation on the base.
3. Tighten lightly the nuts on the clamping bolts. The nuts should be tight enough to prevent the vise from swiveling, yet loose enough to allow the vise to be moved by a tap with the hand or with a light lead mallet.
4. Clamp the assembled indicator in the tool post or to the shank of the tool holder (Fig. 151).
5. Observe that the indicator has a contact shaft perpendicular to the face of the dial. When a vertical surface is being tested, this style of indicator can be read more conveniently than can an indicator with a contact shaft parallel with the face of the dial. (Refer to page 127, Figs. 149 and 152.)
6. Arrange the indicator with the contact point toward, but not touching, the face of the fixed jaw (Fig. 160).
7. Set the stroke of the machine for one inch less than the length of the fixed jaw. (Refer to page 79 for setting the stroke.)
8. Adjust the position of the ram to allow the contact point to

travel within one-half inch of both ends of the jaw. (Refer to page 81 for positioning the ram.)

9. Move the ram to the beginning of the stroke at A (Fig. 160).
10. Move the table until the face of the vise jaw presses against the contact point of the indicator. The finger of the indicator should register about ten one-thousandths of an inch to insure good contact between the face of the jaw and the contact point.
11. Note the measurement on the dial; then move the ram to the forward position at B (Fig. 161).
12. Observe the readings on the dial when the indicator is at each end of the jaw. The difference, if any, between the dial settings should be divided by two; the result is the distance the vise must be swiveled.
13. Tap the vise lightly to move it the necessary distance in a direction away from the higher setting.
14. Tighten the clamping nuts securely and recheck the setting. When the indicator reading is exactly the same at both ends of the jaw, the vise is set parallel with the stroke.
15. Remove the indicator from the machine and carefully replace the parts in a box. Return the indicator to its assigned place.

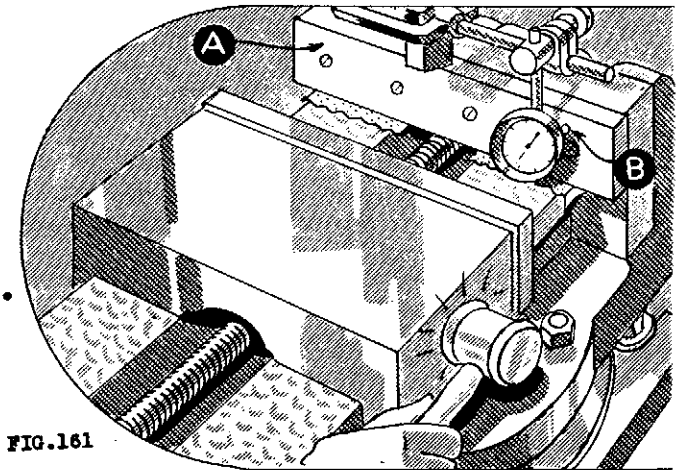

FIG. 161

HOW TO SET THE VISE AT 90° TO THE DIRECTION OF THE STROKE WITH AN INDICATOR

1. Mount the vise on the table if it is necessary to do so, selecting from pages 119 to 121 the correct procedure to suit the type of vise that is being used.
2. Loosen the clamping nuts and set the jaws at 90° to the direction of the stroke. The vise handle will then be toward the front and the zero marks on the vise will coincide with the zero marks on the base.
3. Tighten the nuts lightly on the

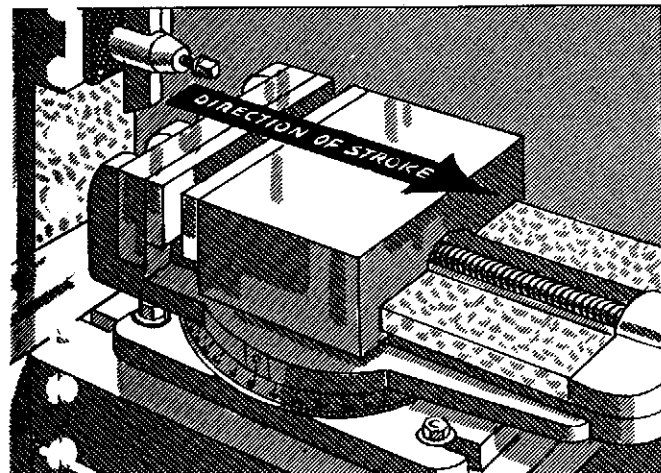

FIG. 162

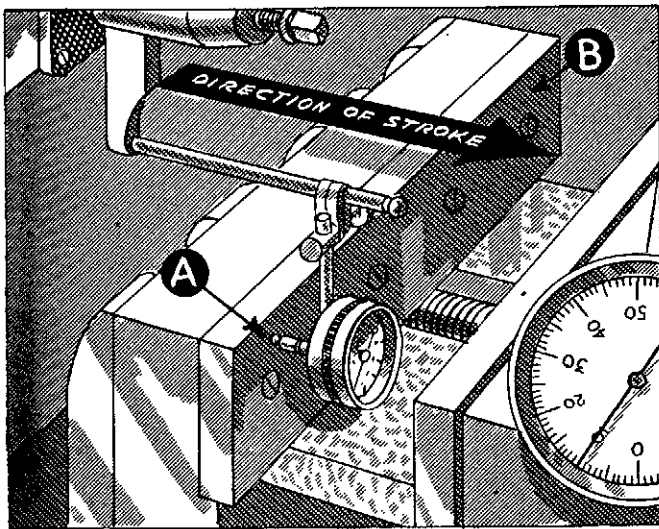

FIG. 163

clamping bolts. The nuts should be tight enough to prevent the vise from swiveling, yet loose enough to allow the vise to move by giving it a tap with the hand or a light lead mallet.

4. Clamp the assembled indicator in the tool post or to the shank of the tool holder.
5. Observe that the indicator has a contact shaft perpendicular to the face of the dial. When a vertical surface is being tested, this style of indicator is more conveniently read than is an indicator with a contact shaft parallel with the face of the dial. (Refer to page 127, Figs. 149 and 152.)

6. Arrange the indicator near the end of the jaw with the contact point toward, but not touching, the face of the fixed jaw (Fig. 163).

NOTE: The contact point is pressed against the face of the jaw either by moving the ram in slightly or by adjusting the clamp which holds the indicator to the tool holder.

7. Adjust the contact point against the face of the jaw by means of the clamp which holds the indicator to the tool holder. Have the pointer register about ten one-thousandths of an inch on the dial (A, Fig. 163).

CAUTION This is probably the safest method of adjusting the indicator. The adjustment can be made by moving the ram, but this should not be attempted unless the action of the ram can be controlled by hand.

8. Note the reading on the dial, and, with the table hand feed, move the vise so that the indicator is in position B.
9. Observe the reading at B.
10. Subtract the lower measurement from the higher measurement and divide the difference by two. The answer is the distance the vise must be swiveled.
11. Tap the vise around the required distance in a direction away from the higher setting.
12. Tighten the clamping nuts and recheck the setting. The indica-

tor should register the same at both ends of the jaw. If there is still a difference between the two readings, the clamping nuts should be loosened and the adjustment continued until the setting is correct.

13. Remove the indicator from the machine, carefully replace the parts in the box, and return the indicator to its assigned place.

HOW TO USE THE SHAPER BOLTS

1. Read the description of shaper bolts on page 105.
2. Insert a T-slot cleaner in the end of the table slot near the apron and draw the cleaner outwards. Repeat this step a few times to clean out all the chips.
3. Brush off the chips that may accumulate around the top of the slots and the surface of the table as a result of cleaning out the slots.

THE SQUARE T-HEAD BOLT

Insert the T-head in the end of the table slot and push the bolt along to the required position.

THE CUTAWAY T-HEAD BOLT

Drop the head of the bolt into the table slot and turn the head.

THE TAPPED T-HEAD BOLT

1. Insert the tapped head into the end of the table slot and move it along into position.
2. Select a stud that will project far enough above the surface of the work to hold a clamp (if necessary), a washer, and a nut.

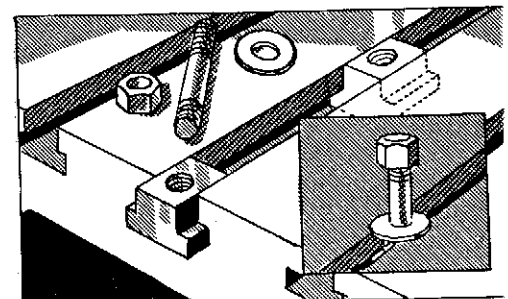
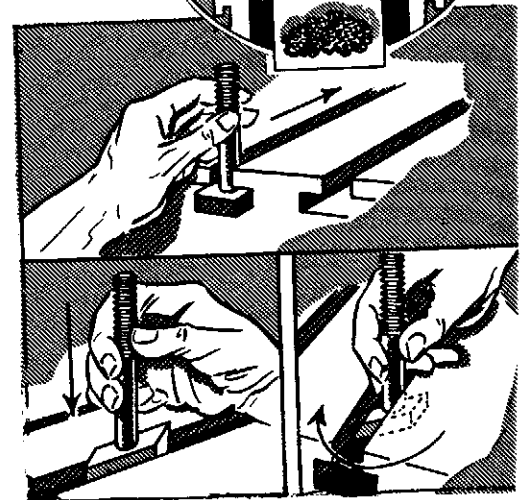
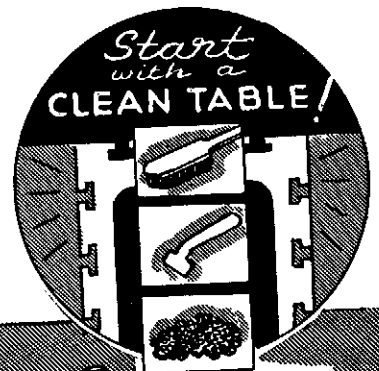
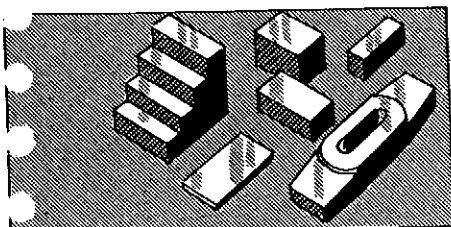

FIG. 164

HOW TO USE CLAMPS, PACKING BLOCKS, AND STEP BLOCKS

1. Read the description of clamps, packing blocks, and step blocks on pages 106 and 115.
2. Select a plain clamp and a block equal to the height of the surface to be clamped. If



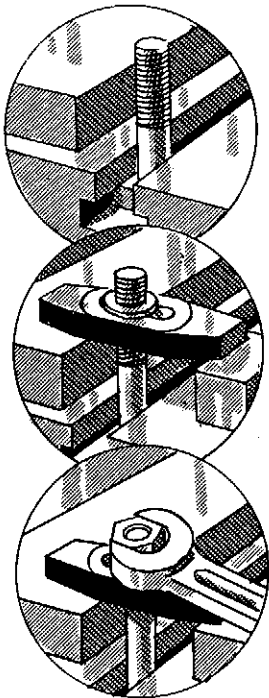

FIG.165

blocks of the exact height are not available, a strip should be placed between the top of the block and the underside of the clamp.

3. Insert a square T-head bolt in the table slot. (Refer to page 135 for instructions.)
4. Place the clamp over the bolt, supporting one end of the clamp on the work and the other on the block. Notice that the clamp must be level and that the bolt must be placed near the clamped surface. (See Fig. 166 for the correct method of clamping.)

NOTE: Because of the location of the table slots and the size and shape of the work, it is not always possible to place the bolt in a position of maximum gripping power but the arrangement emphasized in Fig. 166 should be duplicated whenever practicable.

5. Place a washer and a nut on the bolt and tighten the nut with a wrench. For the description of other types of clamps, refer to page 112.

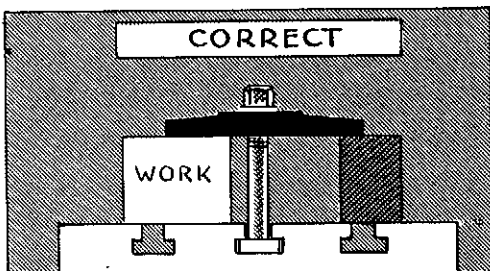

CORRECT

1. Bolt near the work. (Greatest pressure exerted on the work.)
2. Clamp level. (Full area of the face of the clamp bearing on the work, giving maximum gripping power.)

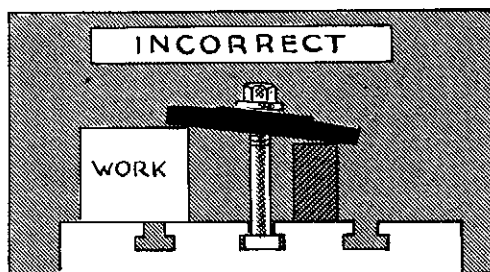

INCORRECT

1. Bolt near the block. (Greatest pressure exerted on the block and not on the work. Corner of the work only is held, providing minimum gripping power.)
2. Clamp not level. (Clamp has tendency to tip the work. Tightening the nut has tendency to bend the bolt.)

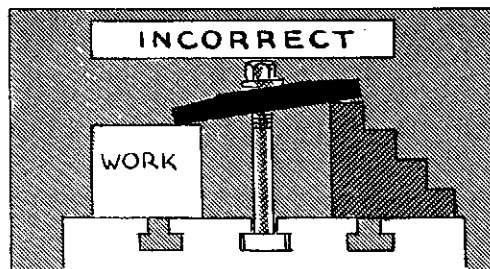

INCORRECT

1. Bolt midway between the work and the block. (Pressure evenly distributed. Greatest pressure needed on the work.)
2. Clamp not level. (Point of clamp only gripping the work. Tightening the nut has tendency to bend the bolt.)

FIG.166

HOW TO USE ALIGNING STRIPS, OR ALIGNING BARS

Edge of the Strip Parallel with the Direction of the Stroke

1. Read the description of aligning strips on page 109.
2. Clean the table and with a file remove any burrs which may be on the table surface.
3. Select two strips similar to the ones illustrated in C and D, Fig. 112. On the undersurface of each of these there is a tongue which, when placed in the table slot, aligns the strip with the direction of the stroke.

4. Place two T-head bolts in the table slot (page 135).
5. Clean the bottom surface of the strip and with a fine file remove any burrs which may be on the base or the sides. If the one illustrated at C is used, take the nuts and washers off the bolts.
6. Place the strip over the bolts and onto the table with the tongues in the table slot. If the strip D is used, it is placed directly on the table and aligned with the tongue in the same manner as strip C.
7. Place the washers and the nuts on the bolts, or, in the case of D, move the bolts into the open lug slots, and tighten the nuts securely. The alignment of the strip can be tested with an indicator as instructed on page 132 if this should be necessary.

Edge of the Strip 90° to the Direction of the Stroke

NOTE: Either of the aligning bars, or strips, shown at A and B may be used for this purpose. If the one at B is selected, it is held to the table with bolts which pass through the slot. The strip A is secured to the table with clamps (Fig 169).

1. Insert the necessary number of bolts in the table slots (page 135).
2. Thoroughly clean the aligning strip with a clean cloth and remove all burrs with a fine file.

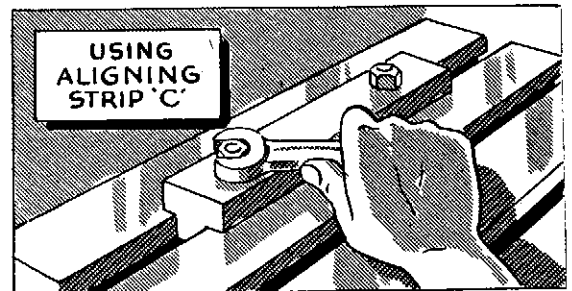

FIG.167

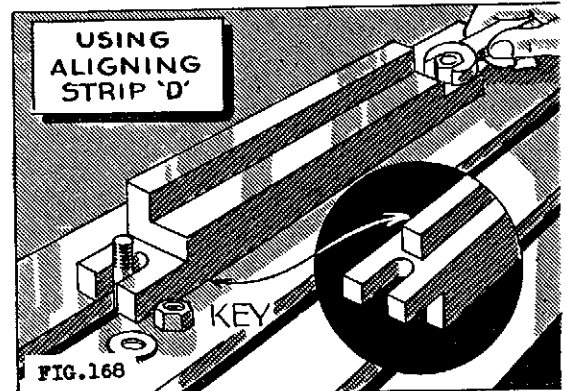

FIG.168

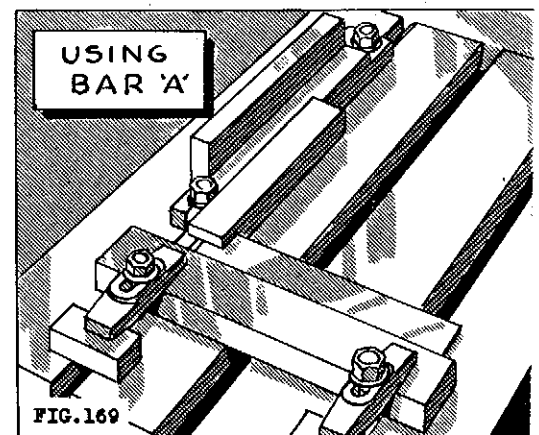

FIG.169

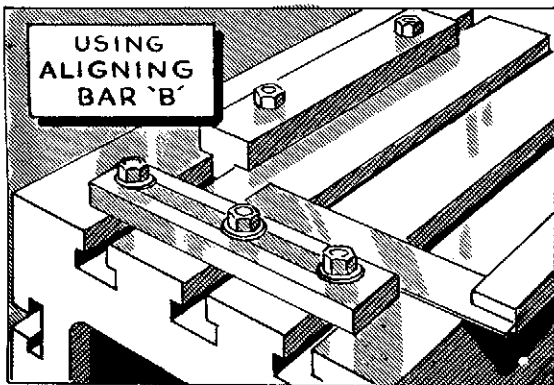

FIG.170

3. Place the strip on the table in the required position. In the case of A, clamps must be used.
4. Use either a try square or a combination square to set the new aligning strip at 90° with the one previously located or at 90° with the edge of the table.

CAUTION

Provision must be made to protect the edges and surfaces of a square from damage by keeping the square in a box or case, or by laying it on a cloth when it is not in use.

5. Place the beam of the square against the first aligning bar and adjust the second aligning strip parallel with and against the blade of the square (Fig. 169).
6. Tighten the nuts lightly to hold the strip in place.
7. Test again for squareness. First, lay two pieces of tissue paper over the strip, and then, with the beam of the square pressed against the first bar, move the square forward until the blade grips the two pieces of tissue paper.
8. Adjust the aligning strip by tapping it with a lead mallet until the force required to withdraw the two pieces of paper is the same.
9. Tighten the nuts down securely when the proper adjustment has been made. The strip may be set also by placing the beam of the square against the edge of the table and aligning the strip parallel with the blade of the square. If a more accurate setting is required, an indicator can be used as instructed on page 133.
10. Return all tools to their assigned places when all necessary adjustments have been made.

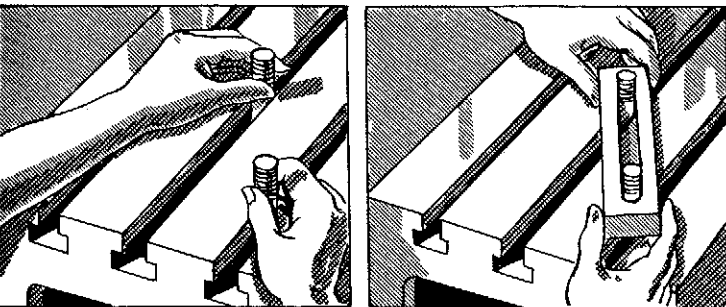

FIG.171

Edge of the Strip at an Angle
on the Table

1. Select one of the strips illustrated at A and B, Fig. 112. If strip B is used, the slot through which the bolts pass may be utilized even when the strip is placed at an angle on the table.

2. Clean the top surface and the edge of the table, and remove any burrs which may be present.
3. Place the bolts in the table slots.
4. Clean the aligning strip and be sure that it is free of burrs.
5. Place the strip over the bolts and set it approximately at the desired angle.
6. Set the protractor at the correct angle.
7. Press the base of the protractor against the edge of the table, and, with the blade extending over the top of the table, adjust the strip against and parallel with the blade of the protractor (Fig. 172).
8. Tighten the nuts just enough to hold the strip in position.
9. Place two pieces of tissue paper over the strip; press the protractor against the edge of the table, and move it forward until the blade grips the two pieces of paper (Fig.173).
10. Adjust the parallel, if necessary, by tapping it lightly with a lead mallet until the force required to withdraw the two pieces of tissue paper is the same.
11. Tighten the nuts down securely when the setting is correct.

NOTE: If an aligning strip already has been set parallel with the stroke, the second strip may be set at an angle with the one located on the table (Fig. 169). In this case, the protractor is substituted for the square, and the strip is set at an angle.

HOW TO USE STOPS

1. Read the description of stops on page 108.
2. Clean out the table slots and clean the surface of the table.

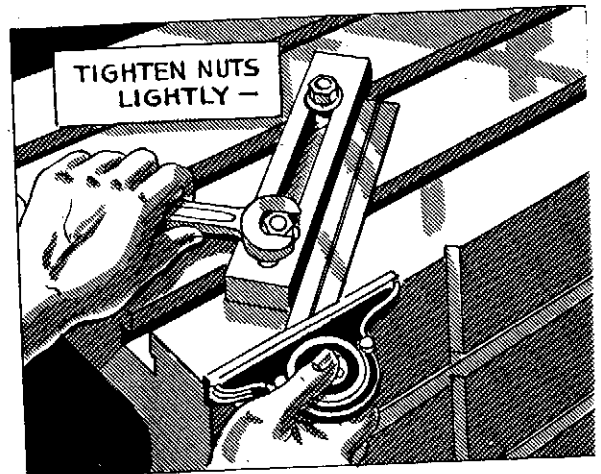

FIG.172

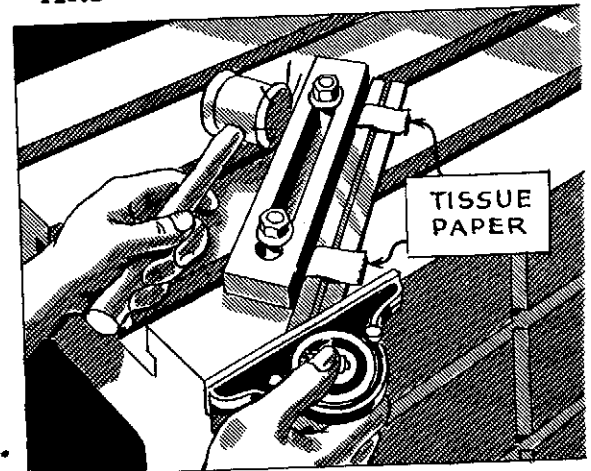
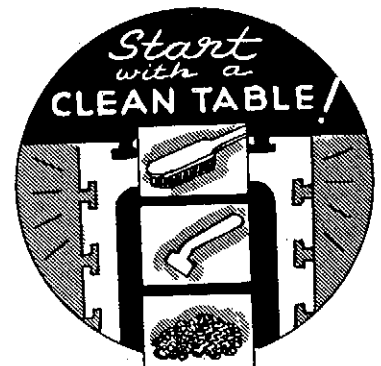

FIG.173



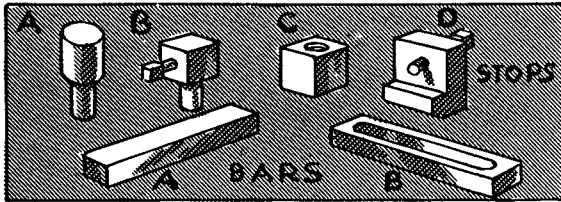

FIG. 174

3. Select two stops from each of the types illustrated at A, B, C, and D, a bar A, and a bar B (Fig. 174).

4. Clean the two stops A, and place them in the round holes located near the front of the table (Fig. 175).

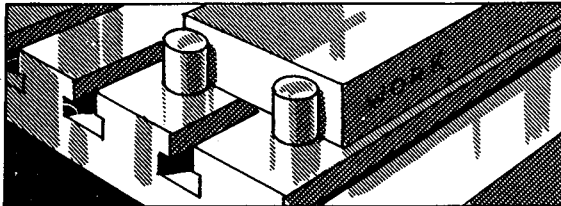

FIG. 175

5. Locate the finished edge of the work against the two stops.

6. Insert a bar between the stops and the contacting surface of the work if the width of the edge is too narrow to catch against the two stops (Fig. 176). For an unfinished or an uneven surface, the stops B are more practical because the screws can be adjusted.

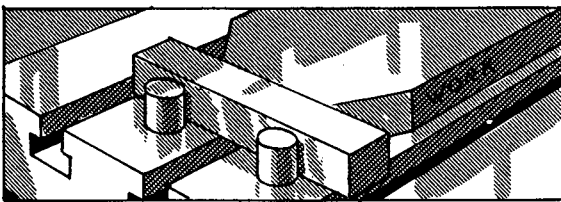

FIG. 176

7. Place the two stops, type B, in the holes in the table. Then, after the work has been located in relation to the stops, the screws can be adjusted to compensate for any unevenness of the edge (Fig. 177).

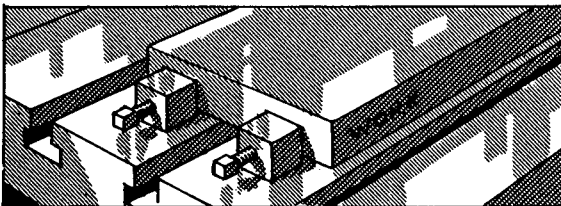

FIG. 177

NOTE: Sometimes the unevenness of the contacting surface, especially in castings, takes the form of lugs or other projections. In this case, place a bar between the stops and the projections on the casting, and adjust the screws to suit. When it is impractical to use the holes on the table to hold stops, the slots can be utilized.

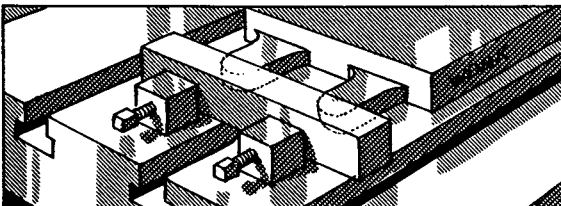

FIG. 178

8. Put a T-bolt in each of the selected table slots and place the bar over the bolts (Fig. 179).

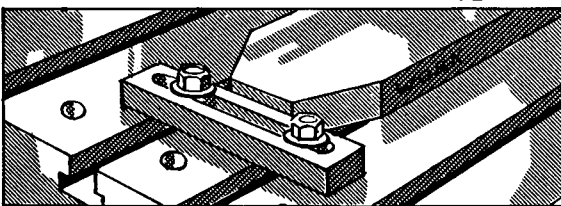

FIG. 179

9. Provide a washer and a nut for each bolt, adjust the stop to the work, and tighten the nuts securely. Individual stops C also may be used with, or without, a bar (Fig. 180).

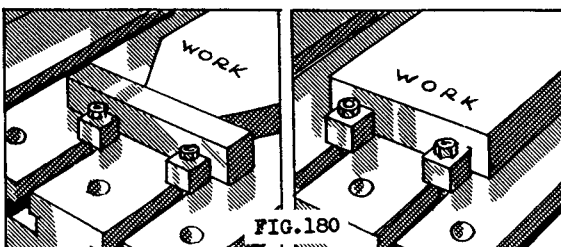

FIG. 180

NOTE: Stops are often used to hold the work by the pressure of the screws. The screws may either force the work against an aligning strip or hold the piece between two sets of stops in the following manner.

1. Arrange on the table and in their proper relation, the work, an aligning strip, and a stop. (Refer to page 137 for setting the strip.)
2. Select three stops with screws set at an angle. The slight angular set of the screws, which is between 5° and 10° , not only will force the work against the aligning strip but also will force the work to the table (Fig. 181).
3. Insert the stops in the end of the table slots and move them along to the desired position.
4. Tighten the screws against the piece to be held, and at the same time lightly tap the work with a lead mallet to seat the work on the table.
5. Note that the work can be held between individual stops or by those arranged in sets, and that the screws may be parallel with the surface of the table instead of set at an angle (Fig. 182). To compensate for different widths of work, strips of various widths can be arranged to be used with any of the stops and slots.

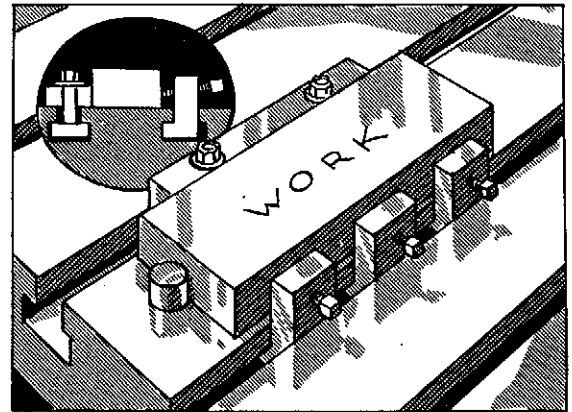

FIG. 181

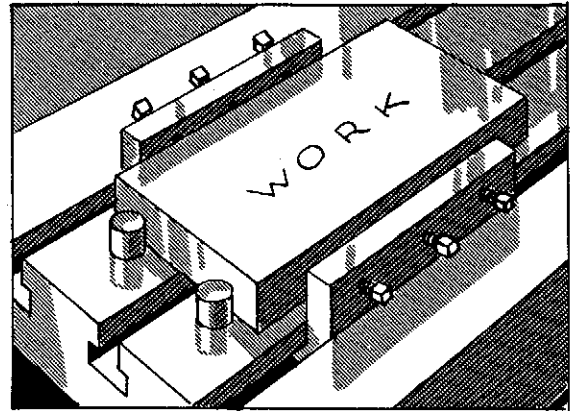

FIG. 182

HOW TO USE TOE DOGS

1. Read the description of toe dogs and stops on page 108.
2. Clean the table surface and clean out the table slots.
3. Arrange the work on the table.
4. Put two round stops in the reamed holes at the front of the table. This will prevent shifting caused by the cutting action of the tool (Fig. 183).
5. Place two stops (Fig. 183) in each of the selected table slots. The number of stops will depend upon the length of the piece; at least two sets should be used unless the piece is so short that there is room for only one set.

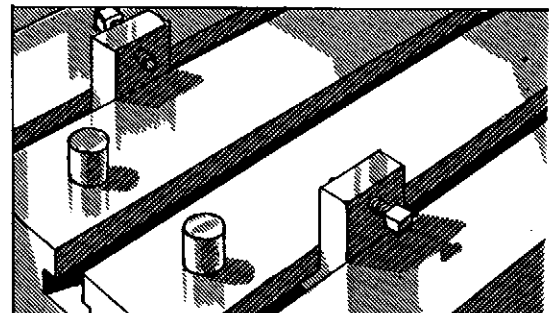
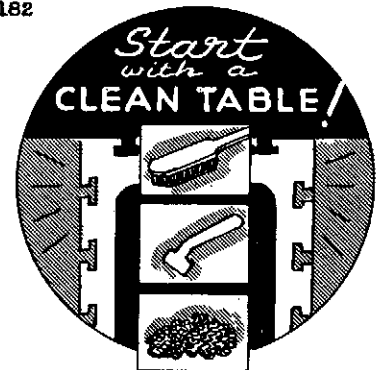

FIG. 183

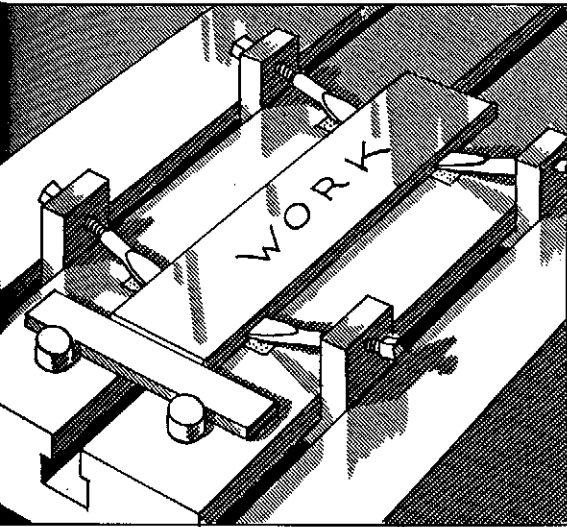

FIG. 184

6. Select four toe dogs with flat ends, two for each side of the work.
7. Place the toe dogs in turn against the sides of the work, supporting the flat ends upon shims and the opposite ends against the screws of the stops (Fig. 184). Shims are not always used, but, when they are employed, the table surface is protected and the contact edges of the toe dogs are steadied.
8. Arrange the toe dogs so that they are set at about the same angle as that of the screws. If the toe dogs are inclined at too great an angle, the pressure of the screws will force the outer end of the dogs upwards, and the pressure against the work will be released.

9. Adjust each screw a little at a time, continuing in order until all screws are sufficiently tight, at the same time tapping the work lightly with a lead mallet in order to seat the work onto the table.

NOTE: The amount of pressure to exert against the screws will depend upon the thickness and construction of the work (its resistance to distortion) and upon the holding power required to overcome the cutting action of the tool. This is largely a matter of experience and judgment.

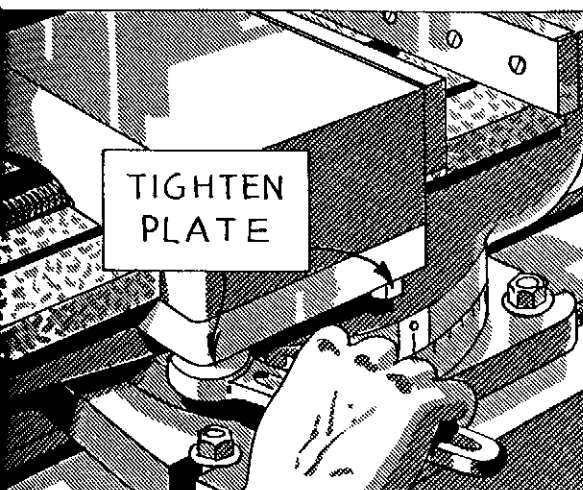

FIG. 185

HOW TO USE HOLD-DOWNS

1. Read the description of hold-downs on page 109.
2. Note that the same principle will be employed to grip the work with hold-downs as was used with toe dogs. In this case, the work will be held between the vise jaws instead of on the table.
3. Mount the vise on the shaper table. (Refer to page 119.)
4. Tighten the plate underneath the movable jaw to prevent excessive lifting

of the jaw when the vise is tightened. This should be done only when necessary and when an adjustment is provided for this purpose (Fig. 185).

5. Open the vise wide enough to place the work and the hold-downs between the two jaws.
6. Select a parallel bar which will raise the work as high as possible in the vise and at the same time allow the hold-downs to be held between the jaws (Fig. 186).
7. Be sure that the vise and all contacting surfaces are clean. If the work has a finished surface, place four pieces of tissue paper on the parallel so that the four corners of the work will rest upon the tissue paper.
8. Place the work upon the parallel with one hold-down on each side (Fig. 186).
9. Tighten the vise jaws to grip lightly the hold-downs against the work.

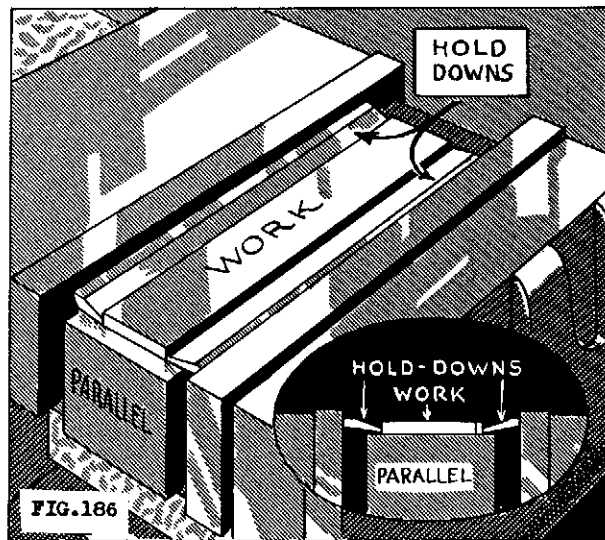

CAUTION The amount of force that may be exerted against the work will depend upon the ability of the material to resist distortion. Also, the cut must be regulated accordingly; otherwise, the cutting action of the tool will push the work forward and out of the vise.

10. Increase the pressure of the jaws against the hold-downs, and at the same time seat the work on the parallels by tapping lightly with a lead mallet.

CAUTION If a heavy blow is struck with the mallet, the work will rebound from the parallel.

11. Test the work for being properly seated by trying to pull out the tissue paper. All four pieces of tissue paper will hold securely when the work is properly seated on the parallels.

HOW TO USE V-BLOCKS

V-Blocks Parallel with the Direction of the Stroke

1. Read page 110 for a description of V-blocks.
2. Clean the table surface and clean out the table slots.



3. Clean the bottom of the V-blocks and with a file remove any burrs from the surface of the V-blocks and the surface of the table.
4. Place the V-blocks on the table with the tongues in the selected slot. The tongues will align the V-blocks with the table slot (Fig. 187).
5. Support the work in the V-blocks (Fig. 189).
6. Insert two T-bolts into the table slot and move them along into position.
7. Select two flat clamps and place them over the bolts.
8. Insert a piece of copper, cardboard, or soft metal strip between the finished surfaces of the work and the clamps.
9. Be sure that the clamp is level and that the bolt is as near as possible to the clamped surface. (Refer to page 135.)
10. Tighten securely the nuts on the bolts.
11. Place a suitable stop against the forward edge of the V-block to take the thrust of the tool. (Refer to page 140.)

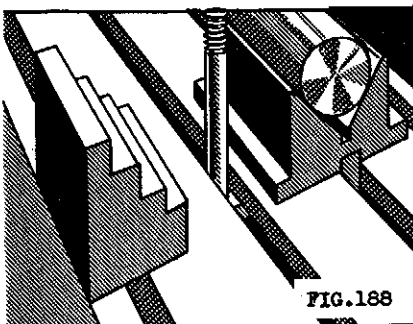
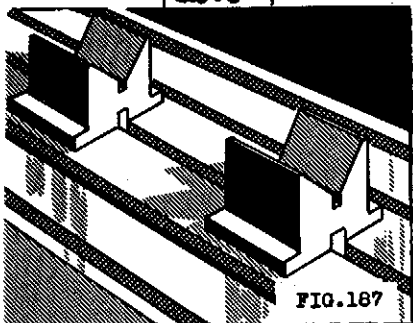

NOTE: As an alternate method of holding the shaft, the V-blocks illustrated in Fig. 190 can be used. These V-blocks are especially handy when a number of duplicate pieces have to be held.

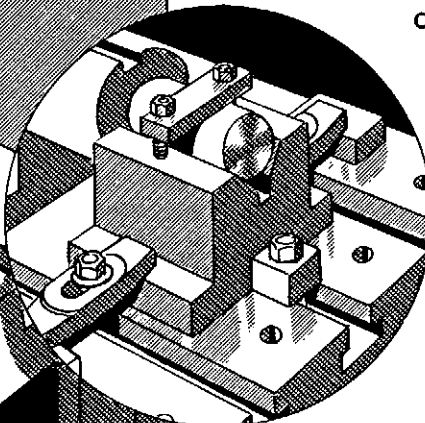
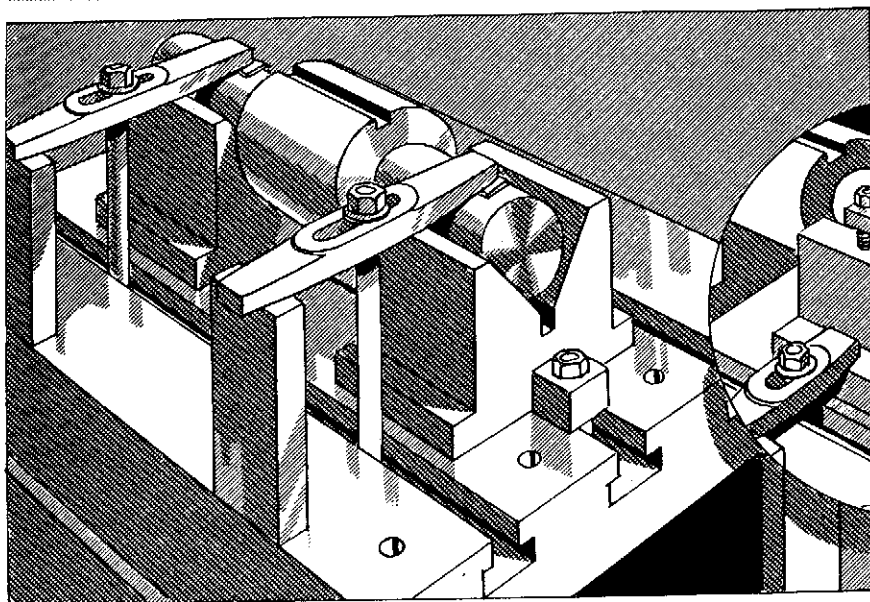

1. Use the same precautions emphasized in directions No. 2 and No. 3 as to cleanliness when mounting the V-blocks on the table.

FIG.189

FIG.190

2. Place the V-blocks on the table with the tongues in the table slot.
3. Strap the V-block to the table and fasten a stop forward and against the front of the block to receive the thrust of the tool.
4. Place the work in the V-block and put the clamp over the bolts; then put on the washers and the nuts. Be sure that a protecting strip of soft metal or cardboard is between the finished surface of the work and the clamp.
5. Hold the clamp level and tighten the nuts down to the clamp with the fingers.
6. Alternately tighten with a wrench each of the nuts a little at a time until enough pressure is applied to hold the object securely.

V-Blocks 90° to the Direction of the Stroke

1. Observe the same precautions regarding cleanliness and care when placing the V-blocks in position as were emphasized in directions No. 2 and No. 3 on pages 143 and 144.
2. Align the V-blocks with each other by placing the work or a test bar in the V-shaped openings.
3. Place a square on the table in a vertical position with the blade touching the shaft as shown at A (Fig. 191).
4. Arrange a combination square in such a position that the blade lies flat on the table surface and the head parallel and against the front edge of the table.
5. Adjust the combination square so that the end of the blade touches the edge of the first square.
6. Arrange the squares in the same manner at the opposite end of the shaft as shown at B.
7. Move the V-block until the edge of the first square is the same distance from

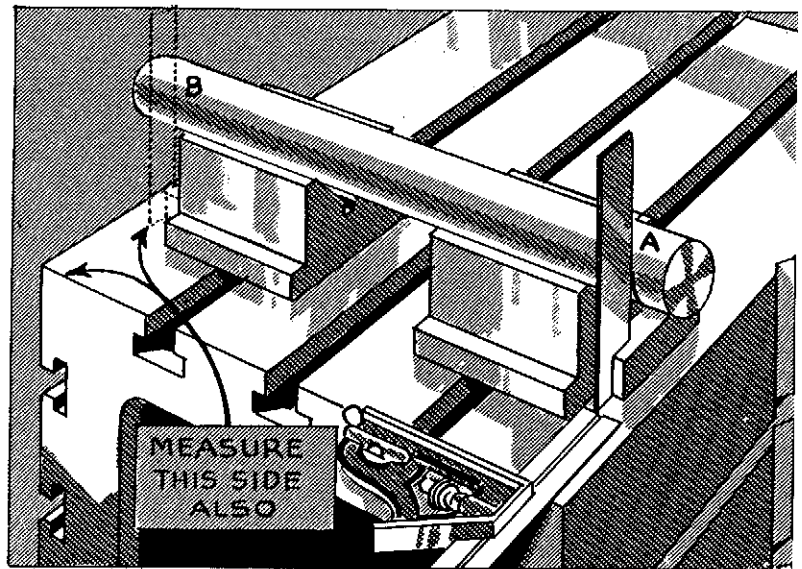
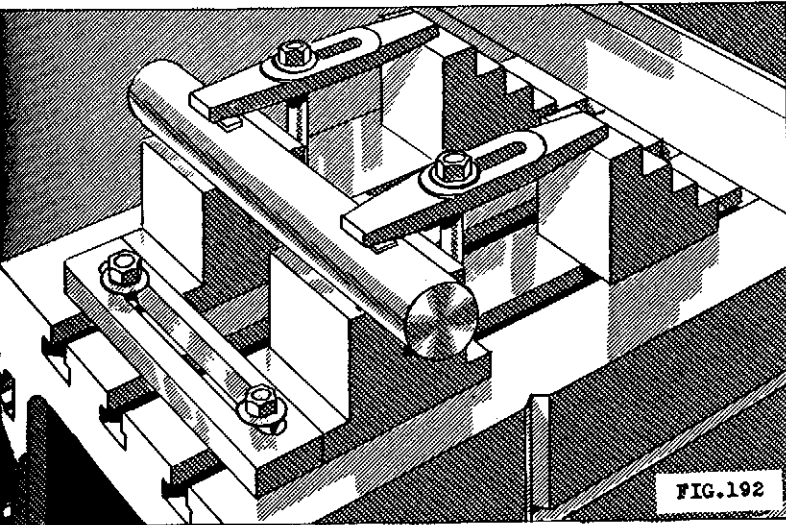

FIG. 191



the front edge of the table as it was when the square was in position A.

8. Bolt a bar stop to the table and against the forward edges of the V-blocks. This will hold the V-blocks in alignment and, in addition, will act as a stop to take the thrust of the tool (Fig. 192).
9. Clamp the round portion of the work with two flat clamps. Use soft metal or cardboard shims between the clamps to protect finished surfaces.

the finished surfaces of the work and the undersides of the clamps to protect finished surfaces.

10. Recheck the alignment; make any necessary adjustments; then tighten the nuts down securely.

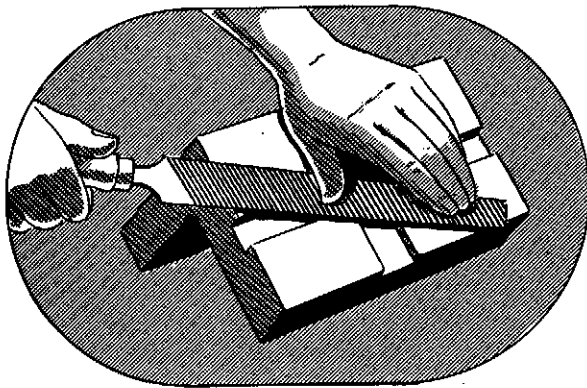

FIG. 193

HOW TO USE ANGLE PLATES, C-CLAMPS, AND JACKS

Angle Plate 90° with the Direction of the Stroke

1. Read pages 111 and 112 for the description of angle plates.
2. Clean the table surface and clean out the table slots.
3. Clean the angle plate and remove with a file any burrs from the faces of the angle plate and the surface of the table.
4. Test the two sides of the angle plate for squareness with a try square. It must be assumed that the square is kept in the tool room, or some other safe place, and checked periodically for accuracy.
5. Place the angle plate on the table with the tongues aligned with

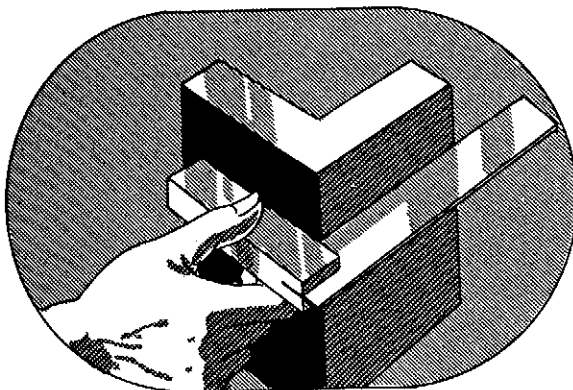
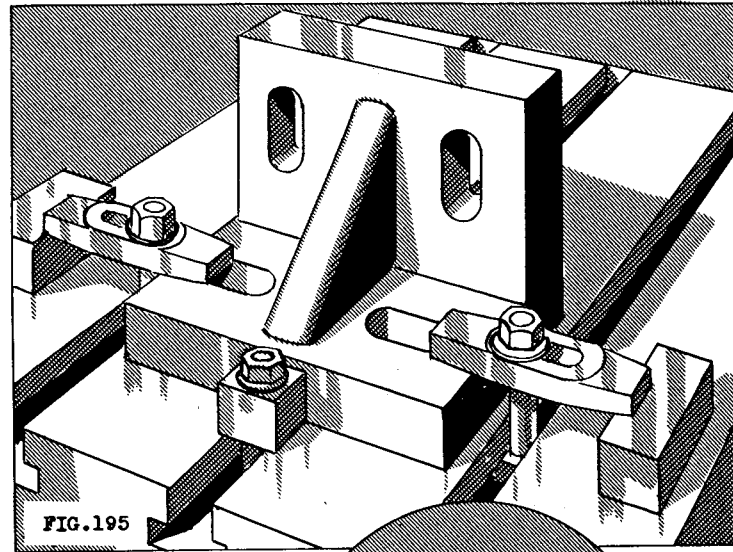

FIG. 194

the central slot of the table.

6. Secure the angle plate to the table with clamps, placing one on each side of the base.
7. Bolt a stop to the table close against the forward edge of the angle plate. This will prevent any movement due to the thrust of the tool (Fig.195).

NOTE: Aligning the plate by means of the tongues in the table slot will be accurate enough in most cases. The angle plate, however, may be tested with an indicator in a manner similar to that used when the vise jaws were being set (page 133). The plate also may be tested for squareness with the table by using a try square.(Fig. 196).



1. Clean the surface of the table, the face of the angle plate, and the beam of the try square.
2. Place the beam of the square on the table with the blade of the square against the face of the angle plate.
3. Examine the face for squareness by observing whether or not the blade of the square is parallel with the face of the angle plate. A more positive method is to use tissue paper between the surfaces to be tested.
4. Insert two pieces of tissue paper between the angle plate and the blade of the square (Fig. 196).
5. Press the beam of the square downward on the table and forward against the angle plate.
6. Withdraw the two pieces of tissue paper. If the force required to remove them is the same, the angle plate will be square with the table. If not, paper shims must be placed under the lower side of the base, or, instead, the angle plate may be removed and the faces reground. Whichever procedure is followed, the test should be repeated until the angle plate is square with the table.

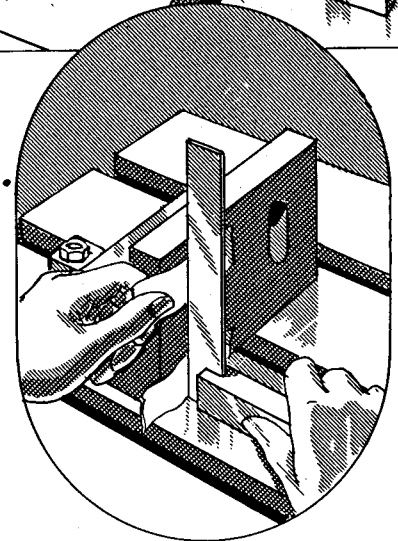

FIG.196

Angle Plate Parallel with the Direction of the Stroke

1. Read pages 112 and 114 for the description of clamps and jacks.
2. Arrange the tongues on the base of the angle plate so that when the tongues are aligned with the table slots the angle plate will be parallel with the direction of the stroke.
3. Observe the same precautions regarding cleanliness and care as were emphasized in directions No. 2 and No. 3, page 146.
4. Test the plate for squareness with a try square (Fig. 194).
5. Insert two T-head bolts in the table slot.
6. Place the angle plate over the bolts and align the tongues with the table slot.
7. Bolt the angle plate to the table.
8. Clean the side of the work and the face of the angle plate.
9. Place a piece of cardboard between the face of the angle plate and the surface of the work if the material being held has a rough surface. This will protect the finished face of the angle plate (Fig. 197).

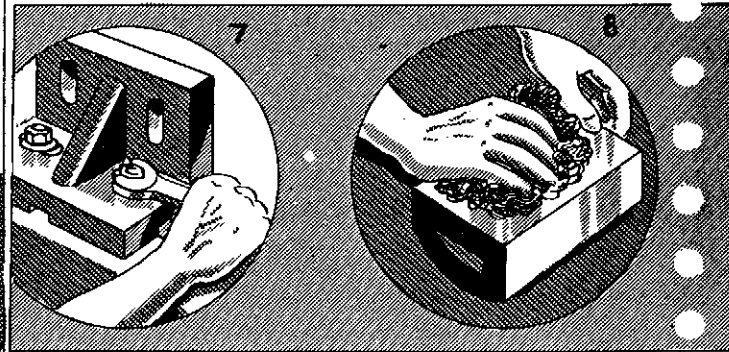
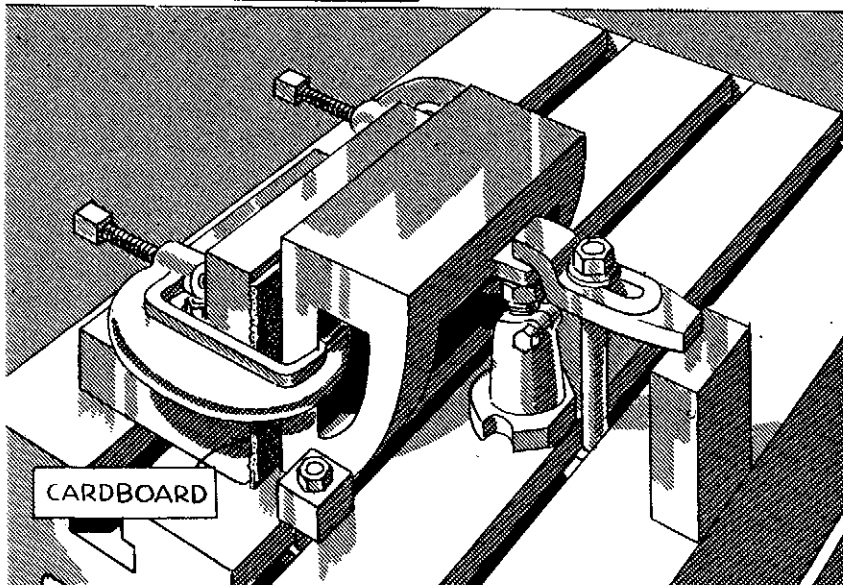
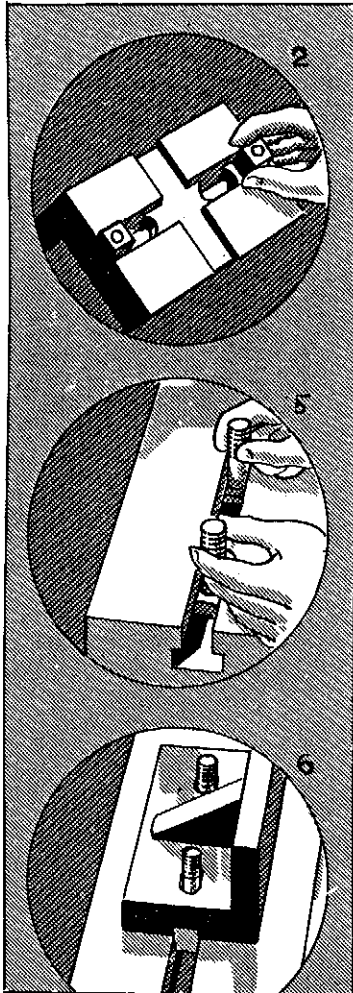
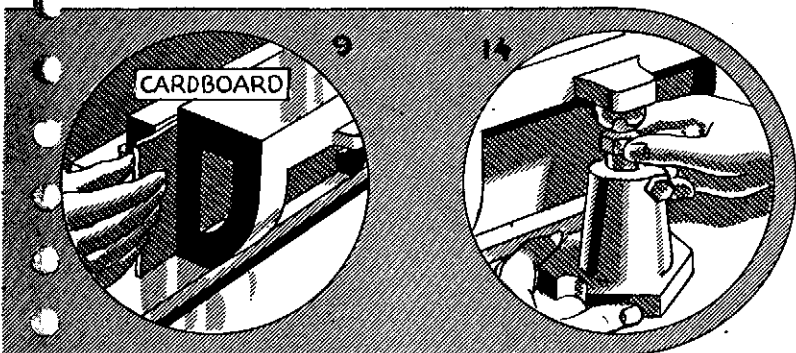

FIG. 197

10. Use two C-clamps to hold the material to the plate.
11. Place a piece of soft metal between the screw and the material being held at one end of the C-clamp, and another piece between the pad of the C-clamp and the material being held at the other end. These pieces will protect the surfaces from being marred by the screw or the pad of the C-clamp. If the surfaces to be held are rough or will not be damaged by marks, the metal packing may be left out.
12. Tighten the C-clamp securely by turning the head of the clamping screw with a wrench.
13. Place a stop against the front edge of the angle plate to take the thrust of the tool.
14. Select a jack of suitable size. The length of the threaded part of the screw that is held in the base should be at least equal to the diameter of the screw.
15. Clean the base of the jack.
16. Place the jack under the unsupported portion of the material. A piece of cardboard is sometimes used under the base of the jack to prevent its slipping or marring the table surface.
17. Adjust the jack screw until the swiveled top touches the material to be supported and there is a slight tension when the screw is turned.
18. Arrange a clamp so that the work will be clamped directly above the part supported by the jack.
19. Place a piece of cardboard or soft metal under the clamp if it is necessary to protect the finished surface.

20. Tighten the nut on the T-head bolt.

NOTE: The angle plate may be tested for parallelism with the direction of the stroke as instructed on page 132, and for squareness with the table as directed on page 147, Fig. 196.



HOW TO USE MACHINIST'S, OR PARALLEL, CLAMPS

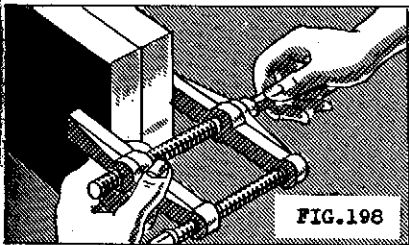
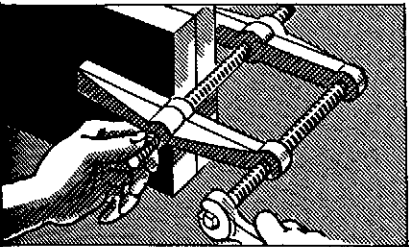
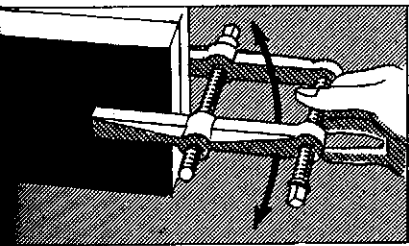

FIG.198

1. Read page 113 for the description of machinist's clamps. Parallel clamps often may be used instead of C-clamps to hold parts together. They are usually used in pairs.
2. Open the jaws of the clamp a distance equal to the combined thickness of the parts to be held.
3. Place the clamp over the parts to be held. If protecting strips are necessary, cardboard or soft metal should be placed between the jaws of the clamp and the finished surfaces.
4. Tighten the front screw with the fingers until the clamp grips the work and the jaws of the clamp are parallel.
5. Tighten the back screw securely by using a lever or round rod which has been inserted into the head of the screw.

NOTE: If the clamp is holding firmly with maximum gripping power and both jaws are in contact along the entire surface that is being held, the clamp will not move. A little experience with adjusting parallel clamps will soon give the trainee the knack of adjusting the clamp properly. Fig. 199 illustrates both the correct method and the incorrect methods of adjusting the clamp.

CORRECT: Jaws are adjusted parallel with surface being clamped. This insures maximum holding power. Clamp will not move up and down.

INCORRECT: Jaws are not parallel with surface being clamped. Jaws are holding with minimum gripping power. Jaws open at the front. Clamps move up and down.

INCORRECT: Jaws are not parallel with surface being clamped. Jaws are holding with minimum gripping power. Jaws are holding on the point only. Clamps move up and down.

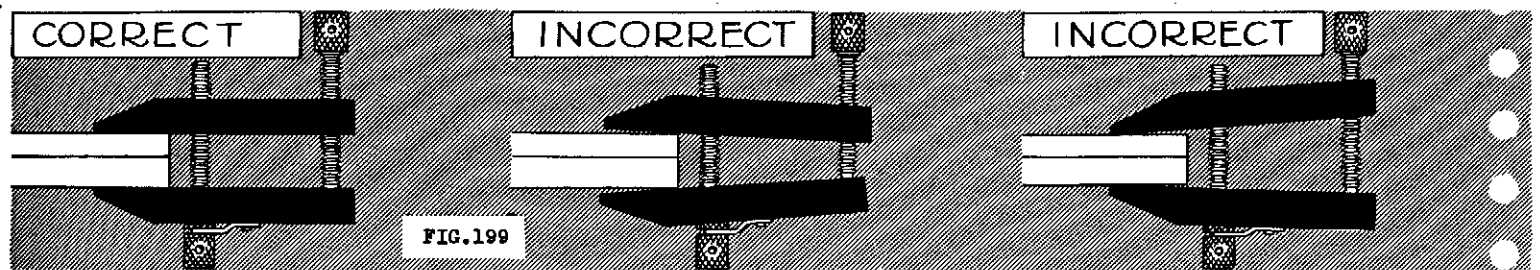

FIG.199

DESCRIPTION OF SHAPER TOOL HOLDERS AND SHAPER TOOLS

Unit 1-T52(C) Parts I and II Pages 151 to 166

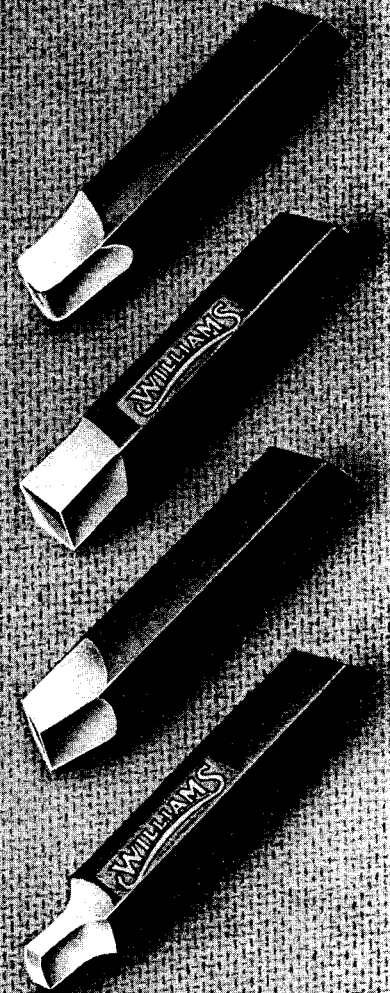
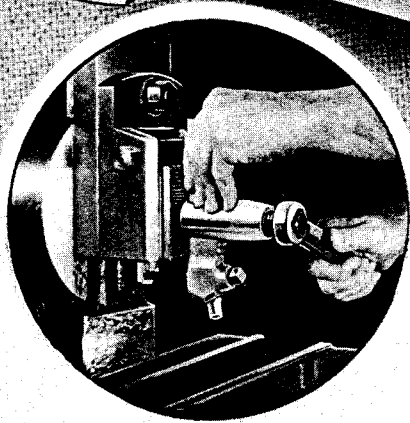

Photo by courtesy of J. H. Williams & Co.



UNIVERSITY OF THE STATE OF NEW YORK
STATE EDUCATION DEPARTMENT
BUREAU OF INDUSTRIAL AND TECHNICAL EDUCATION

DESCRIPTION of SHAPER TOOL HOLDERS

OBJECTIVES OF UNIT

1. To explain the terminology used in connection with tool holders.
2. To describe the various types of tool holders used for shaper work.
3. To become familiar with manufacturers' designations of tool-holder styles.

INTRODUCTORY INFORMATION

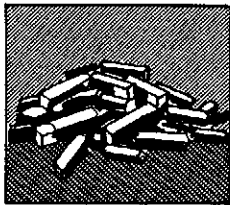

The introduction of tool holders instead of solid forged tools into the machine-tool industry was principally a matter of economy. The first attempts to hold tools in holders, although ingenious, allowed the tool to slip under heavy cuts and often lacked the rigidity so necessary for general use.

As a result of the introduction of more expensive steels for cutting tools, much money was invested in the production of costly forged tools, and considerable time was required to forge, grind, and shape these tools. In addition, waste was unavoidable, for when the tools became too short to be held in the machine they were discarded and eventually scrapped.

Gradually, as improvement in the designs of tool holders has been made, the use of these devices has been extended. Now, as a result of improved designs, tools are securely and solidly held, grinding has been reduced to a minimum, forging is unnecessary, and waste has been reduced considerably. Although proportionately larger and stronger tool holders are designed to be used in the larger machines, solid tools are still extensively used in the heavy machine-tool industries.

In addition to the standard tool holders, there are those which can be purchased in sets. The sets contain a number of standard tools or bits which fit into a special holder. A set of these cutters is adequate for the usual shaper operations, but extra cutters usually may be purchased, and special ones can be made to order.

The American Society of Mechanical Engineers has adopted a set of definitions which apply to all single-point tools, including tool holders. As these definitions have not been adopted by all users and manufacturers, the student should take particular notice of how the terms are applied in each case.

DESCRIPTION OF TOOL HOLDERS

SIZE AND STYLE

To the shaper operator, the size of the tool holder depends principally upon the size of the shank which will fit into the tool post of the machine. It is also necessary for the operator to decide whether or not the tool holder should be straight or offset, right-hand, or left-hand, and to select the style of holder to suit the shape of the tool.

The straight-shank tool holder (Fig. 200) holds the tool parallel with the sides of the tool holder in contrast to the bent style (Fig. 201) which holds the tool at an angle with the sides. These tool holders also may be left or right, depending upon the inclination of the tool either to the left or to the right of the work.

According to the American Standard as issued by the American Society of Mechanical Engineers and published in the American Machinists' Handbook, "A bent tool has the point bent to the left or right (Fig. 201) to make its operation more convenient. These tools are called left-bent tools if the point is bent to the left when looking at the tool from the point end with the face upward and the shank pointing away, and vice versa."

As a tool holder can be classified as a tool shank, this definition can be applied to a tool holder. Conventional usage, however, has not yet entirely adopted the definition, and for this reason four examples of two leading tool-holder manufacturers' products are shown in Fig. 202.

It should be noticed also that the term offset, instead of bent, is used to describe these holders.

The tool holder shown at A is designated as a right-hand offset tool holder; the one illustrated at B is a left-hand offset. The tool holder shown at C which holds a side-cutting tool is

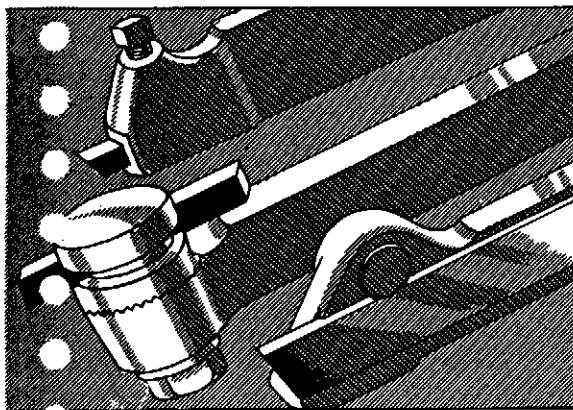

FIG. 200

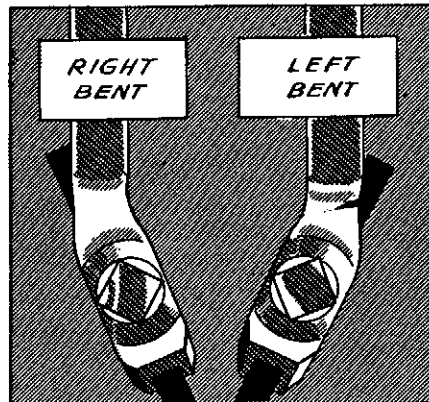

FIG. 201

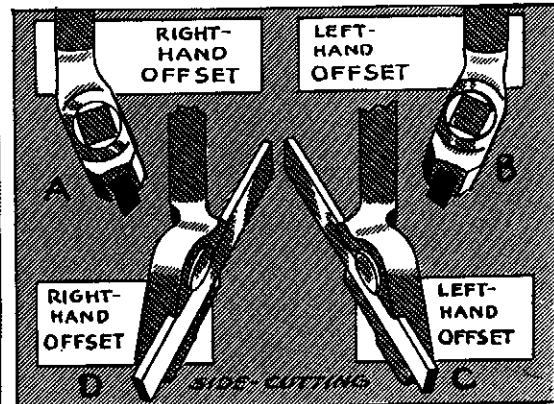

FIG. 202

also a left-hand offset holder, although it is bent in the direction opposite to that of B. Notwithstanding that the tool holder is "bent" to the opposite side compared with the one portrayed at B, the tool which it holds will cut on the same side of the work. The tool holder shown at D is correspondingly a right-hand offset side-cutting tool holder.

The style of tool holder is also influenced by the cross-sectional shape of the tool (Fig. 200). It is understood, of course, that the tool is selected first to suit the style of cut, the nature of the material, and the kind of work.

Tool holders are designated by a manufacturers' number, usually with a letter placed either before or after the number or, in other instances, a letter may be placed both before and after the number. The letter S, R, or L after the number indicates that the holder is straight, right-hand, or left-hand; the letter before the number frequently is the manufacturer's identification of the style of cutter. For example, a designation T-2-S would indicate that the tool holder is to be used to hold a 3/8" square tool bit and has a 5/8" x 1-1/2" x 8" straight shank. This would fit in a tool post with a maximum tool capacity of 7/8" x 1-1/2".

TYPES OF TOOL HOLDERS

Tool holders may be classified according to the method of holding the tool in relation to the shank of the holder: (1) those which hold the tool parallel (horizontal) with the shank of the holder; (2) those which incline the tool at a slight angle with the shank; (3) those which incline the tool at a steep angle with the shank.

Each of the three holders illustrated in Fig. 200 is designed to hold the tool parallel with the shank of the tool holder. The tool to be used in these three tool holders is ground to the required shape and with the necessary clearances, and unless the tool is held parallel, the angle at which the point of the tool is presented to the work will be changed and the clearances also will vary.

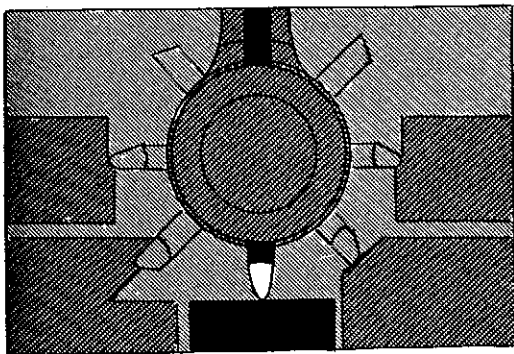
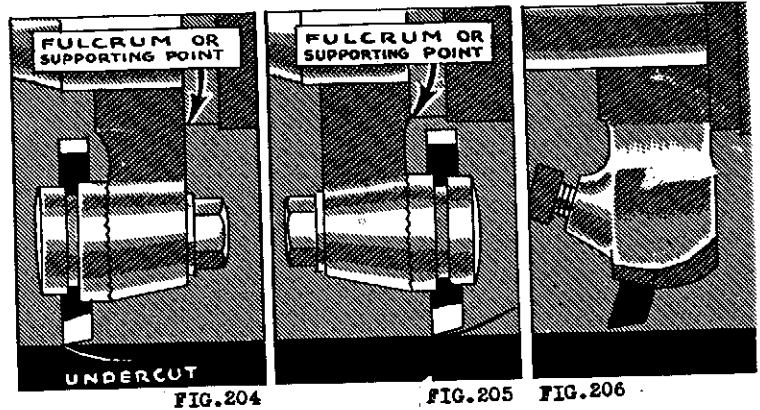

FIG. 203

An exceedingly handy device is the shaper-and-planer tool holder shown in Fig. 203. The tool is held parallel with the shank, but may be set at almost any angle to cut on the right- or left-hand side of the work. The tool holder may be held in the shaper in the conventional manner (Fig. 204) with the cutting edge ahead of the supporting surface, or the tool holder may be turned around to act as a gooseneck tool with the cutting edge behind the fulcrum (Fig. 205). In the former case, the tool has a tendency to spring into the

work when cutting, whereas the spring of the tool is away from the work when it is held in the latter position.

As the tool is held parallel with the shank of the tool holder, the clearances and angles are easily determined and ground without having to take into consideration the inclined angle of the tool (Fig. 206).



In this second group of holders the tool is inclined at a slight angle. The slight angle at which the tool is held, called the tool-holder angle, should be such that it will eliminate, as much as possible, grinding the top of the tool. For shaper work, a satisfactory tool-holder angle is 15° (Fig. 206), the grinding in this case being mostly to give the tool both front and side clearance.

The remaining two examples in this classification (Fig. 207) incline the tool at a steep angle which should correspond to the most satisfactory clearance angle for the front of the tool. This type of tool holder, however, is not extensively used for general shaper work, but it has some merit when used to hold formed tools. The tool in this case can be ground on the top without changing the contour of the tool if the top surface is always ground at the same angle.

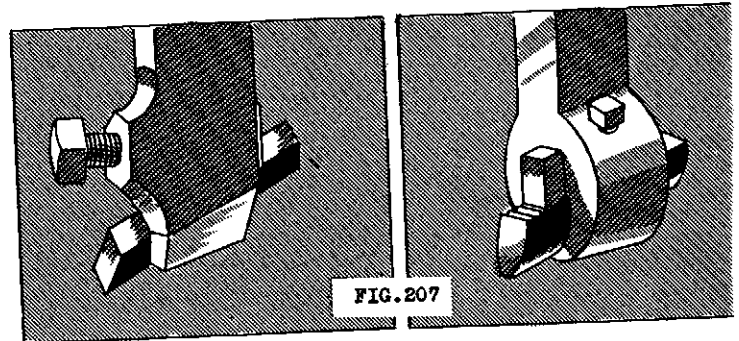

CLAMPING METHODS

Two principal methods are used to clamp the tool in the shaper tool holder: first, a direct clamping action caused by the pressure of a screw; second, a wedging action produced either by a cam or by a drawbolt.

An example of the first method is shown in Fig. 208. A tool is inserted in a rectangular or square hole in the front of the holder and is forced down by the direct pressure of the screw.

In the second case, the tool is

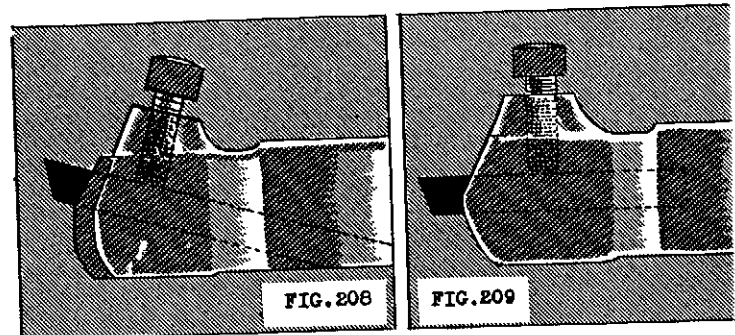

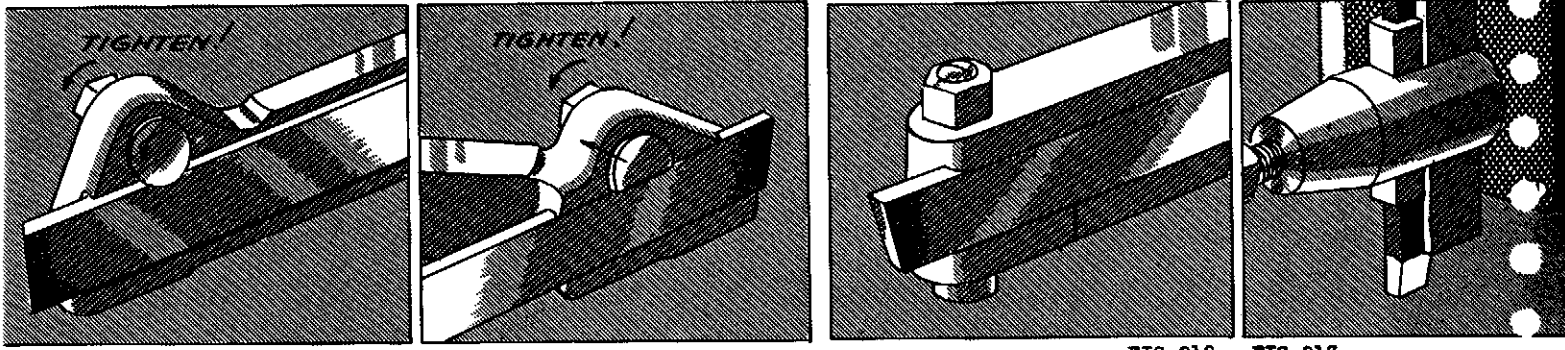

FIG. 210 FIG. 211

FIG. 212 FIG. 213

wedged against the bottom ledge of the tool holder by a cam action (Fig. 210). As the cam is turned with a wrench it presses downward against the tool in such a direction that, as the cutting action of the tool tends to force the tool into the tool holder, it wedges tighter as the pressure increases. The tool can be easily released by turning the cam in the direction opposite to that indicated by the arrow.

The drawbolt is another adaptation of the wedging action which also can be used very effectively with flat tools (Fig. 211). The cutter is placed in a slot in the side of the tool holder and is held in position with a tapered-head bolt with a flat side. As the bolt is drawn in, the tapered surface forces the bolt downwards and the pressure of the flat side of the head on the tool holds it in place.

Fig. 212 and Fig. 213 illustrate two other methods of holding the tool in the tool holder.

There are also on the market patented sets of tools and tool holders which have many convenient features. The set illustrated in Fig. 214 is made especially for shaper work by the "OK" Tool Company.

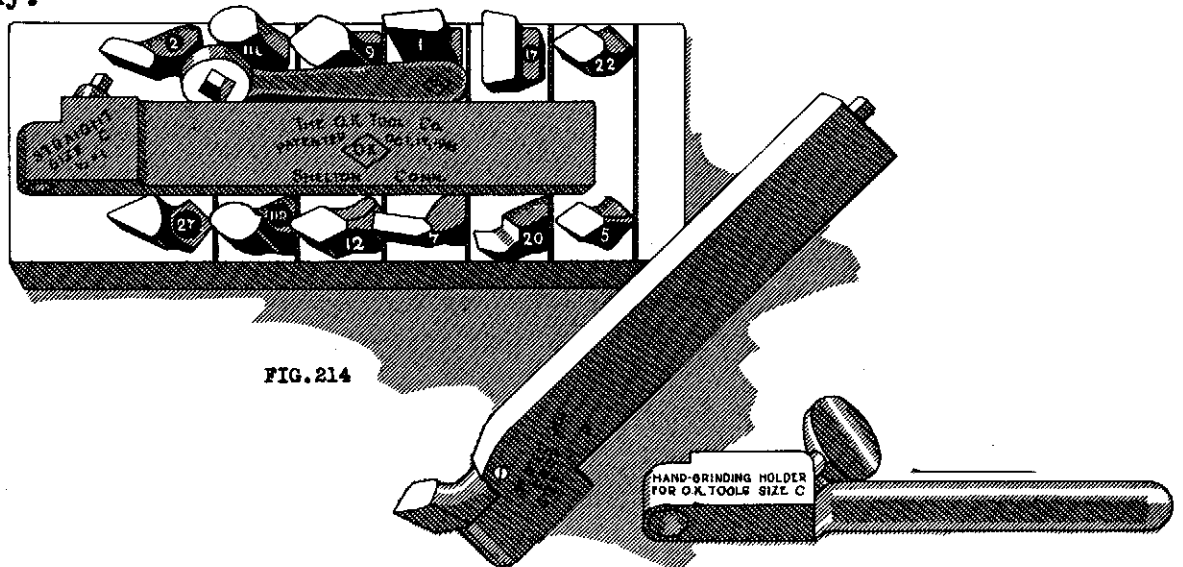

FIG. 214

DESCRIPTION *of* SHAPER TOOLS

OBJECTIVES OF UNIT

1. To understand the terminology used in connection with cutting tools.
2. To become familiar with the various shapes of tools.
3. To visualize and understand the angles of clearance, the angles of rake, and the lip angle of the tool.

INTRODUCTORY INFORMATION

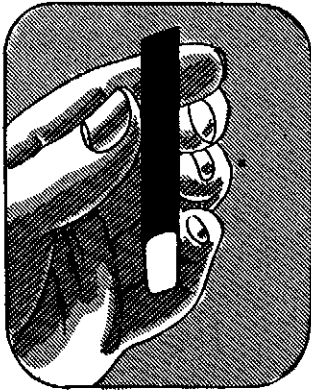

Tools used in the shaper may be forged or ground to shape from solid steel bars or they may be smaller pieces of steel which are held and clamped in a tool holder.

The shape of the tool varies considerably with the character of the work. To give examples of the various shapes of tools for every purpose and at the same time to satisfy every individual mechanic's preference for form would take up more space than is allotted in this monograph. In addition, the terms applied to single-point tools and tool holders are not entirely consistent. Although attempts have been made to standardize these terms, conventional usage so far has frustrated the attempts to apply them in every case.

There are certain principles, however, which the beginner must understand before he can use and grind cutting tools intelligently. For example, a tool may cut very satisfactorily for general work, but may not be satisfactory for sustained, heavy-duty production cuts.

The same caution should be observed in this section regarding terminology as was observed in the section dealing with tool holders. The terms adopted by the American Standards Association have not been accepted by all users and manufacturers, and, therefore, some explanation may be necessary when standard terms differ from those in conventional use.

It should be understood that changes of this character take time and often require considerable expense on the part of manufacturers. Eventually, however, that which is best for the industry as a whole will finally be adopted.

CUTTING TOOL TERMINOLOGY

The shaper tool, or cutter, is a piece of high-grade steel which is shaped, hardened, and ground to a cutting edge. It is securely held in the tool head of the shaper and made to pass across the work and take a series of cuts.

The tools may be forged from steel bars or they may be smaller pieces of steel inserted in a tool holder. The cutters are usually square or rectangular in shape, except in cases where tools are made in sets to fit special types of tool holders.

The shape, or form, of the tool depends chiefly upon the shape of the cut, although it is influenced by the kind of finish required and the kind of material to be machined; the rake, the cutting angle, and the clearances, on the other hand, depend principally upon the nature of the material. All of the foregoing considerations are governed by certain basic underlying principles which have been determined as a result of experimentation and observation.

A discussion of tools is better understood if some of the terms used to describe these tools are defined. The following American Standards' definitions apply to some of the more common terms used in connection with single-point cutting tools. A more complete list of definitions will be found in the American Machinists' Handbook.

POINT - The point is all that part of the tool which is shaped to produce the cutting edges and face (Fig. 215).

SHANK - The shank is that part of the tool on one end of which the point is formed or the tip or bit is supported. The shank in turn is supported in the tool post of the machine (Fig. 215).

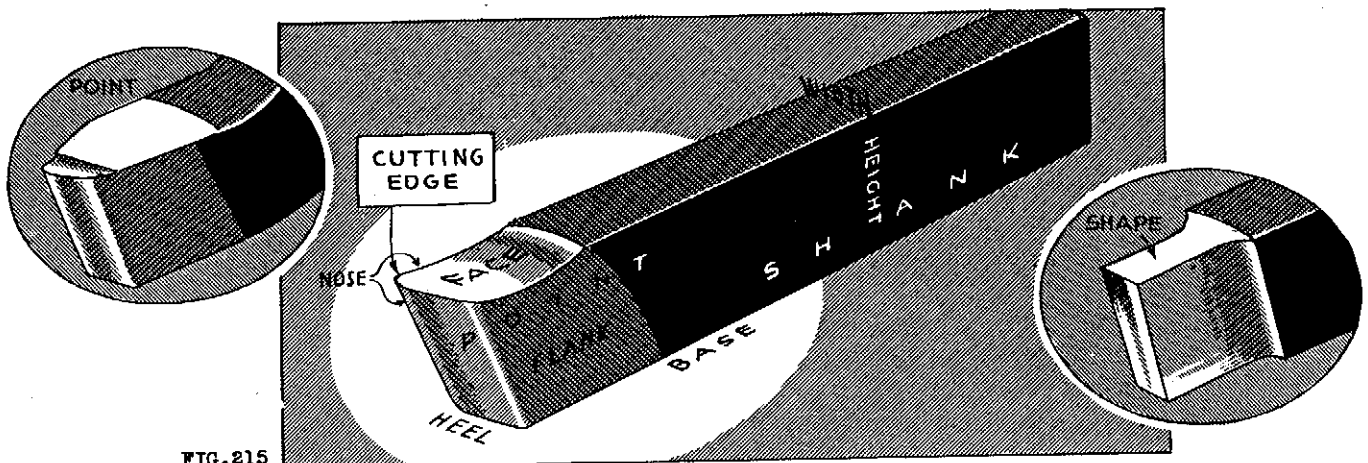

FIG. 215

FACE - The face is that surface on which the chip impinges as it is cut from the work (Fig. 215).

CUTTING EDGE - The cutting edge is that portion of the face edge along which the chip is separated from the work. The cutting edge consists usually of the side-cutting edge, the nose radius, and the end-cutting edge (Fig. 215).

SHAPE - The shape of the tool is the contour of the face when viewed in a direction at right angles to the base (Fig. 215).

WORKING ANGLES - The working angles are those angles between tool and work which depend not only on the shape of the tool, but also on its position with respect to the work.

CUTTING ANGLE - The cutting angle is the angle between the face of the tool and a tangent to the machined surface at the point of action. It equals 90° , minus the true-rake angle (Fig. 216).

LIP ANGLE - The lip angle is the included angle of the tool material between the face and the ground flank measured in a plane at right angles to the cutting edge. When measured in a plane perpendicular to the cutting edge at the end of the tool, it is called the end lip angle. When measured at the point of chip flow, it is called the true lip angle (Fig. 217).

BACK-RAKE ANGLE - The back-rake angle is the angle between the face of a tool and a line parallel to the base of the shank or holder measured in a plane parallel to the center line of the point and at right angles to the base. The angle is positive if the face slopes downward from the point toward the shank and is negative

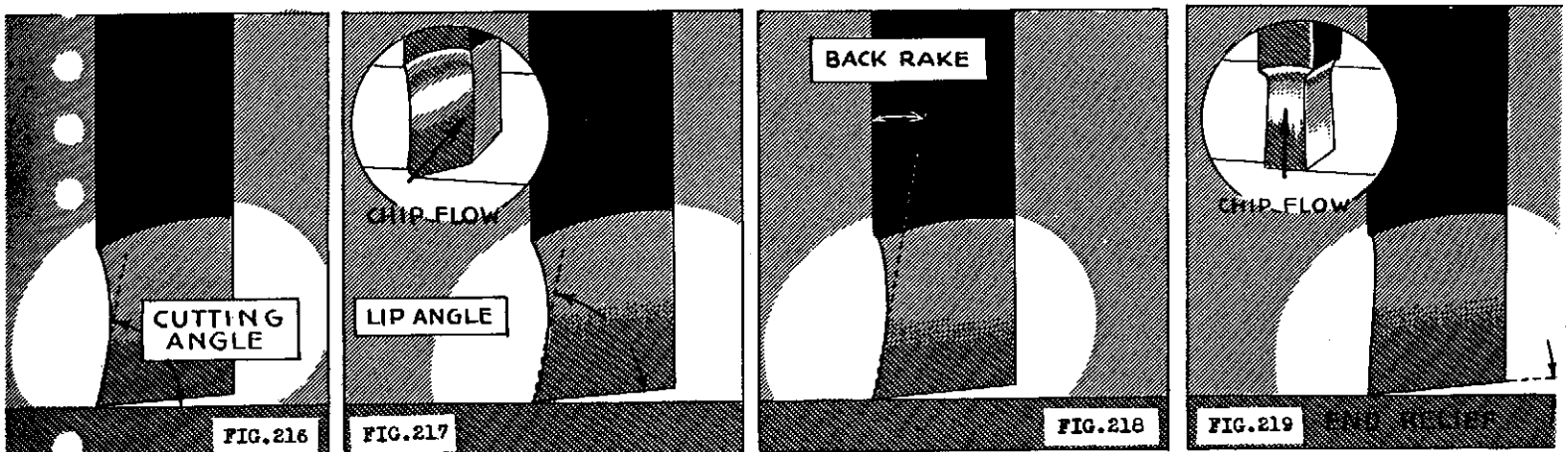

if the face slopes upward toward the shank (Fig. 218).

END-RELIEF ANGLE - The end-relief angle is the angle between the portion of the end flank immediately below the cutting edge and a line drawn through that cutting edge perpendicular to the base. It is measured in a plane parallel to the center line of the point (Fig. 219).

SIDE-RELIEF ANGLE - The side-relief angle is the angle between the portion of the flank immediately below the cutting edge and a line drawn through this cutting edge perpendicular to the base. It is measured in a plane at right angles to the center line of the point (Fig. 220).

SIDE-RAKE ANGLE - The side-rake angle is the angle between the face of a tool and a line parallel to the base. It is measured in a plane at right angles to the base, and at right angles to the center line of the point (Fig. 220).

TRUE-RAKE ANGLE - The true-rake angle (or "top-rake"), under actual cutting conditions is the actual slope of the tool face toward the base from the active cutting edge in the direction of chip flow. It is a combination of the back-rake and side-rake angles and varies with the setting of the tool and with the feed and depth of cut (Fig. 221).

RIGHT-CUT TOOL - A right-cut single-point tool is one which, when viewed from the point end of the tool, with the face up, has the cutting edge on the right side (Fig. 223).

LEFT-CUT TOOL - A left-cut tool has the cutting edge on the left when looking at the point end with the face upward (Fig. 222).

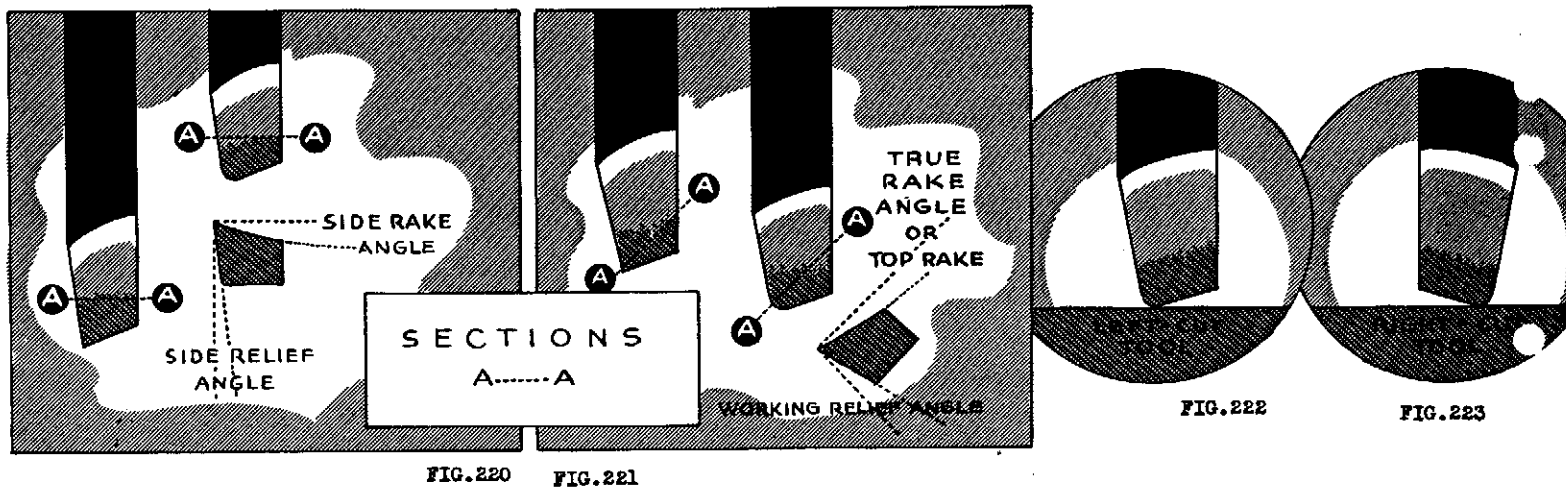

FIG. 220 FIG. 221

FIG. 222

FIG. 223

BENT TOOL - A bent tool has the point bent to the left or right to make its operation more convenient. These tools are called left-bent tools if the point is bent to the left when looking at the tool from the point end with the face upward and the shank pointing away, and vice versa (Fig. 224).



FIG. 224

SIDE-CUTTING-EDGE ANGLE - The side-cutting-edge angle is the angle between the straight side-cutting edge and the side of the tool shank. In the case of a bent tool this angle is measured from the straight portion of the shank (Fig. 225).



END-CUTTING-EDGE ANGLE - The end-cutting-edge angle is the angle between the cutting edge on the end of the tool and a line at right angles to the side edge of the straight portion of the tool shank (Fig. 225).

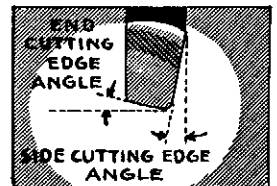

FIG. 225

THE SHAPE OR FORM OF THE TOOL AS VIEWED FROM THE TOP

The shape of the tool may be curved, flat, or its sides may converge to a sharp point. The form of the tool will depend principally upon the surface being machined. For example, a tool with a curved surface could not be used to produce a rectangular slot or to produce a sharp corner, and, in contrast, a tool with a sharp corner would not be recommended for a curved surface or for roughing a flat surface.

Usually there is a difference between the roughing and the finishing tool; in addition, a tool may be offset, or bent, to the right or to the left and may feed either in a right-hand or left-hand direction.

A tool with a rounded nose may be used to rough out both steel and cast-iron surfaces, and with slight modification may be used to produce a finish cut. Frequently, the shear-cut tool (Fig. 226) is preferred for finishing steel, whereas a tool with a flat end shaped as in Fig. 227 is extensively used to finish cast iron.

The three tools illustrated in Fig. 228 should give satisfactory results when used in the shaper to produce flat horizontal surfaces.

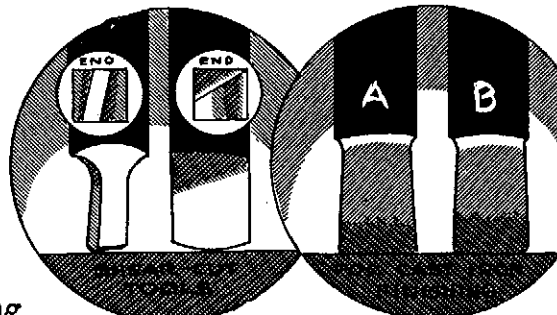

FIG. 226

FIG. 227

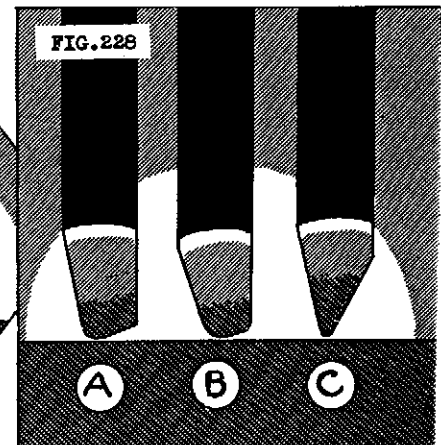

FIG. 228

The tool shown at A is recommended for roughing cuts. It has a side-cut-

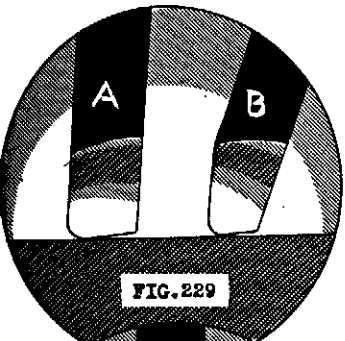

FIG. 229

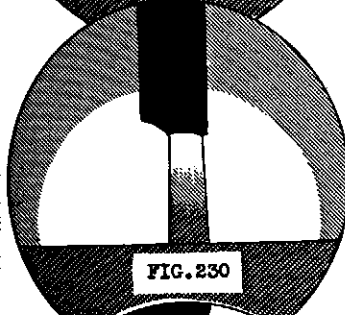

FIG. 230

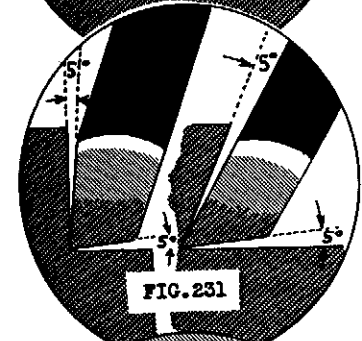

FIG. 231

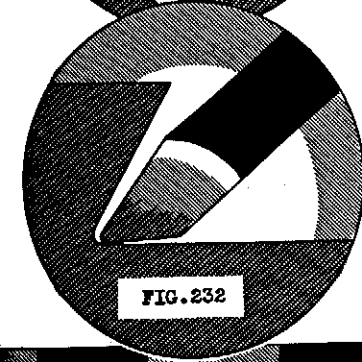

FIG. 232

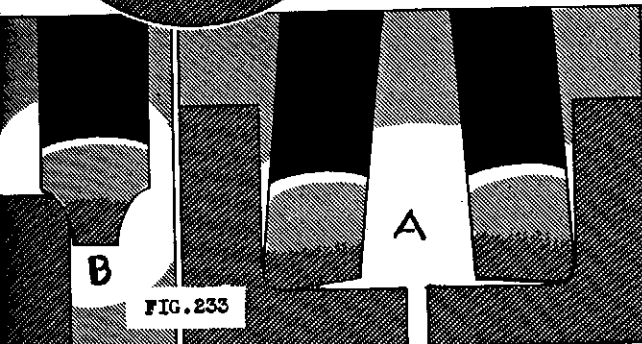

FIG. 233

ting-edge angle of 8° , an end-cutting-edge angle of 15° , and a $1/16''$ radius on the nose of the tool. The slight variation of the round-nosed tool shown at B is preferred by many for roughing cuts. It has a side cutting-edge angle of 20° and a large radius on the nose. The large radius on the nose is often objectionable when this tool is used for fine cuts, roughing out radii, and in other instances where a broad surface on the tool is likely to produce chatter. This may be overcome by using a tool with a small radius as illustrated at C.

Similar in shape to the tool for shaping horizontal surfaces is the roughing tool for down, or vertical, cutting (Fig. 229). The tool is ground to an angle of about 85° with a small radius on the nose. The side cutting edge should be parallel with the side of the tool A or may be offset slightly B to give clearance for the tool holder.

For finishing cast iron, the tool A (Fig. 227) is extensively used and will give excellent results. The corners of the tool may be sharp or they may be rounded slightly as in B.

Whenever it is desired to finish the surfaces of steel, the shear-cut tool (Fig. 226), when used with a little coolant, will produce a smooth, bright finish. (Refer also to Fig. 248.)

In addition to being used to finish cast iron, the square-nosed tool (Fig. 230) can be used to cut slots and to cut off material. The tool is made considerably narrower when used to cut off material, and is ground to the desired width for cutting slots.

A tool that is used to finish square or acute angular corners is ground as in Fig. 231. This tool is ground at an angle from 5° to 10° less than the angle of the corner which it is intended to cut. As the extreme point of this tool will break down easily, it is not suitable for roughing cuts. For roughing, the nose of the tool should be rounded (Fig. 232).

Convenient tools for rounding the edge or for cutting the radius of a corner formed by two 90° surfaces are the radius tools (Fig. 233). These tools are made in two styles, male and female, to suit either an inside or an

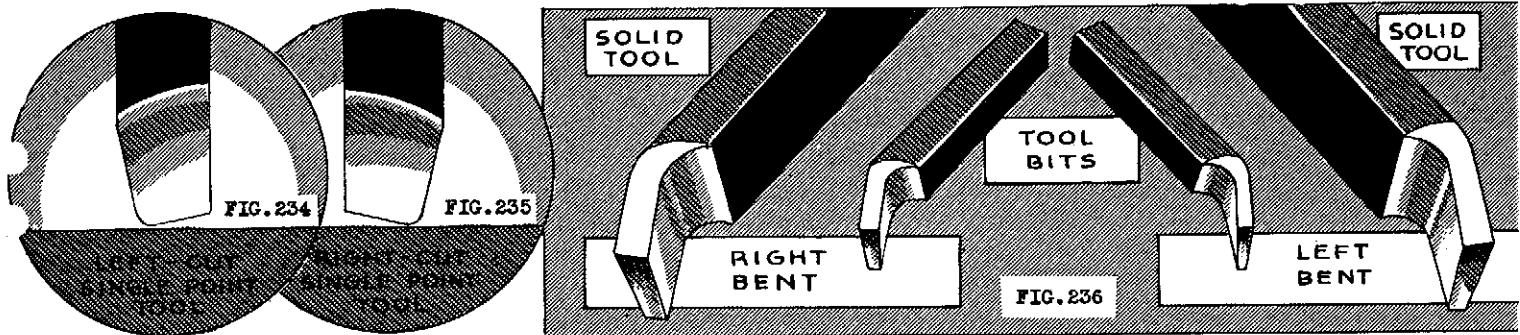

outside radius. The male radius tool **A**, should be ground at an angle of about 85° to give enough clearance for the sides when the inside radius is being cut. Frequently this radius can be cut out with the nose of the round-nosed roughing tool. The corners of the female radius, tool **B**, also should be given a slight relief to prevent it from cutting into the adjoining flat surfaces.

As it is necessary at times to shape both sides of a job without taking the work out of the vise or the machine, tools are made to cut on the right-hand or left-hand side of the work. These tools are referred to as right-hand or left-hand tools, or right-cut or left-cut tools.

According to the American Standard Association definition, "A right-cut single-point tool is one which, when viewed from the point end of the tool, with the face up, has the cutting edge on the right side" (Fig. 234). "A left-cut tool has the cutting edge on the left when looking at the point end with the face upward" (Fig. 235).

Here again, we find that terminology and use of shaper tools are not entirely consistent with these definitions. Some manufacturers still prefer to designate these in the opposite manner.

The same situation exists with the bent tools. In American Standard terminology, right and left single-point tools are designated as in Fig. 236. At the same time, some users still favor the old method of naming them oppositely.

This situation always exists whenever terminology is changed or standardized. The important characteristics, nevertheless, of the tool, such as clearance, rake, cutting angles, and shapes, seem fairly well established and, after all, these are the important features to the shaper operator.

CLEARANCE, RAKE, AND LIP ANGLE

The purpose of clearance, both on the side and the end of the shaper tool, is to allow the cutting edge to do the cutting and the back of the cutting edge to clear the work.

It should be realized that the shaper tool does not feed sideways

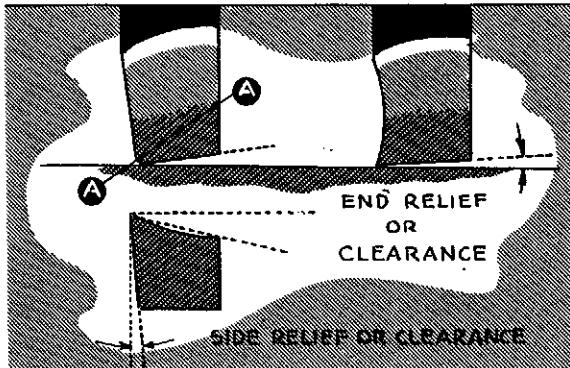

FIG. 237

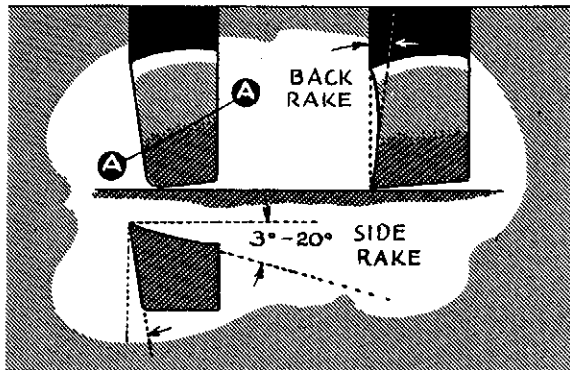

FIG. 238

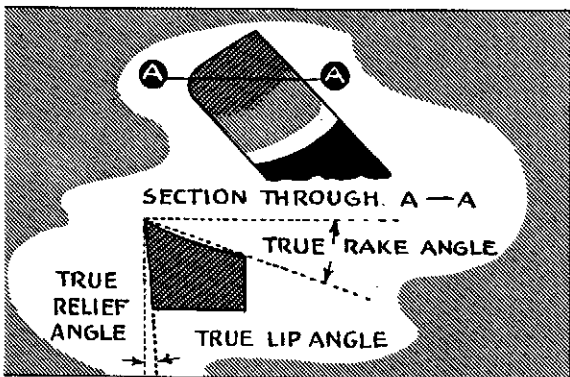
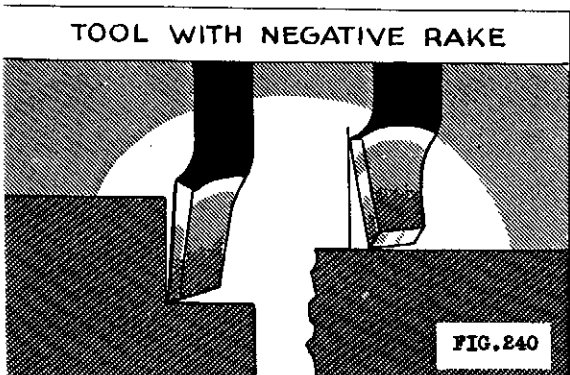

FIG. 239



into the work during the actual cutting; therefore, a clearance of 2° to 6° with an average of 4° is usually considered adequate clearance for the side and the end of the tool. The effective clearance would, in the case of a round-nosed tool, be a combination of the side and front clearance measured at the nose of the tool (Fig. 239).

The side slope and back slope, or side rake and back rake (Fig. 238) are more subject to variation than the front and side clearances. It is the amount of side and back rake which has the greatest influence upon the true lip angle of the tool (Fig. 239).

Theoretically, the rake should be ground on the tool to reduce the amount of power required for cutting and to reduce the wear resulting from the enormous pressure required to peel off the chip. On the other hand, the least possible rake should be given in order to support the cutting edge and prevent it from wearing and crumbling away.

Thus we are confronted with two opposite requirements, one which requires the edge to be as sharp as possible, and the other which tends to avoid a sharp cutting edge. The amount of rake must be determined then as a compromise between the above two opposite requirements. The tool should be sharp enough to cut with maximum efficiency, but at the same time blunt enough to support the cutting edge sufficiently and yet produce the desired finish on the various metals.

With the foregoing principle in mind, the student should realize that no set rake is satisfactory for all metals and under all conditions. Some very satisfactory results, however, have been obtained with the following rake angles: for steel, a side rake of 10° to 20° and a back rake of 2° to 8° ; for cast iron, a side rake of 3° to 10° and a back rake of 0° to 3° .

Occasionally, a side-cutting tool may be given a negative rake (Fig. 240). As the tool moves forward it first strikes the work above the extreme point, softening the blow slightly and reducing the tendency to break off the

tip of the tool.

As mentioned previously, the lip angle of the tool is influenced by the amount of rake and the clearance of the tool. For instance, if a tool has 3° clearance on the side and a side slope of 15° , the lip angle at that point will be 72° (Fig. 241).

These tools are ground to be used with a tool holder which holds the tool parallel (horizontal) with the shank (Fig. 245).

Often the only type of tool holder available is one which will hold the tool at a 15° angle of inclination (page 155). This angle must be taken into consideration when the tool is ground. If the tool is inclined 15° in the tool holder and a 3° relief angle (front clearance) is required, 15° plus 3° , or an 18° relief angle must be ground on the end of the tool in order to compensate for the 15° slope and to give 3° clearance (Fig. 242).

The same procedure must be followed in regard to the back rake of the tool. Since the tool is set at 15° , the back slope will also be 15° , and this, with a 3° relief, will give a lip angle of 72° (Fig. 243). If for cutting cast iron a back relief of 2° were required, then the cutter would be ground on the tip to a lip angle of 85° (Fig. 244).

The side relief and the side rake are also affected by the 15° inclination, but not in the same proportion as are the end relief and the back relief.

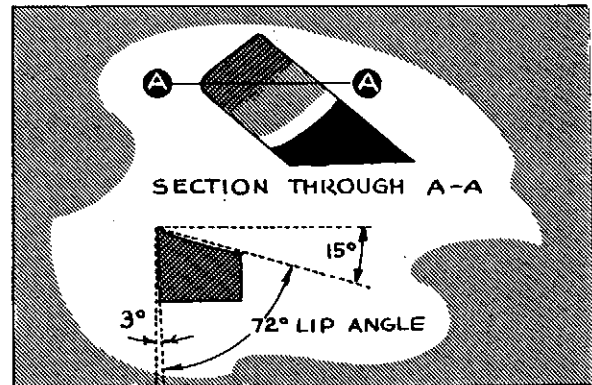

FIG. 241

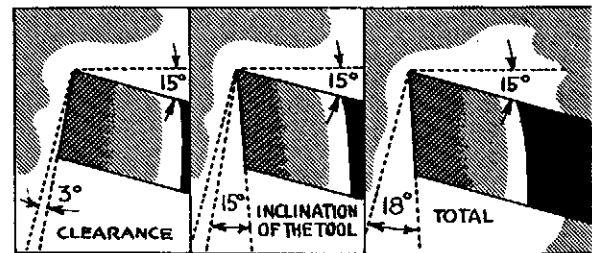

FIG. 242

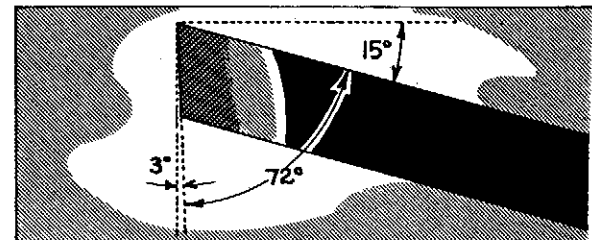

FIG. 243

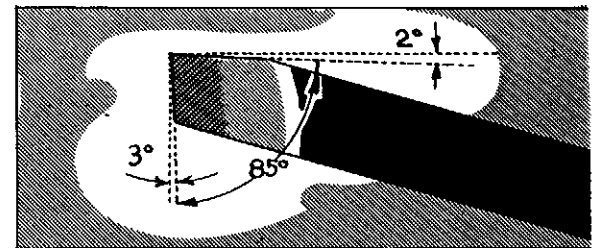

FIG. 244

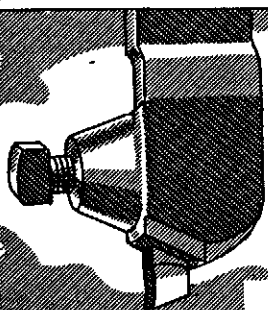

FIG. 245

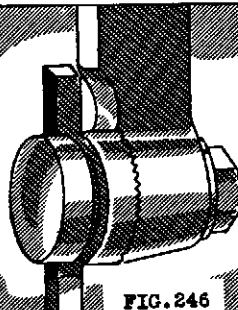

FIG. 246

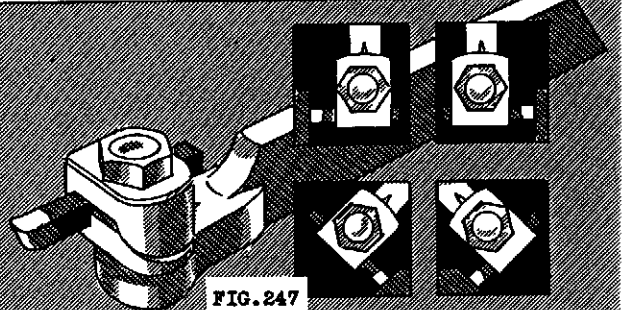
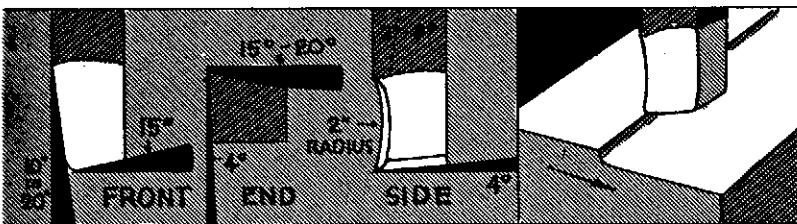

FIG. 247

The following tools are designated to conform to the terminology of the American Standards Association definitions. The indicated cutting angles and the clearances are to be used when the tool is held parallel (horizontal) with the shank of the holder.

LEFT-CUT ROUGHING TOOL FOR STEEL



LEFT-CUT ROUGHING TOOL FOR CAST IRON

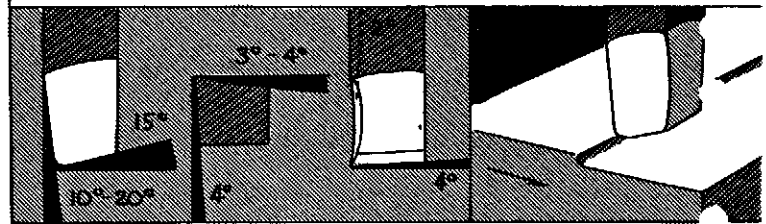

LEFT-SIDE CUT TOOL FOR STEEL

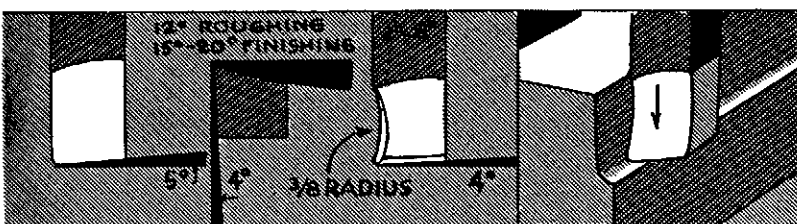

LEFT-SIDE CUT TOOL FOR CAST IRON

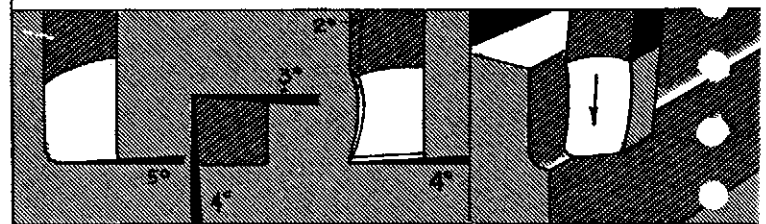

FINISHING TOOL FOR CAST IRON - CORNERS MAY BE ROUND

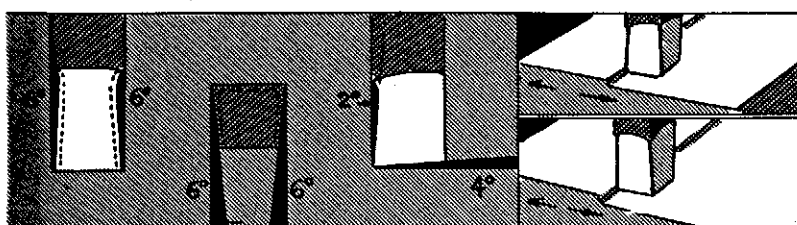

SIDE-CUTTING TOOL FOR SQUARING CORNERS

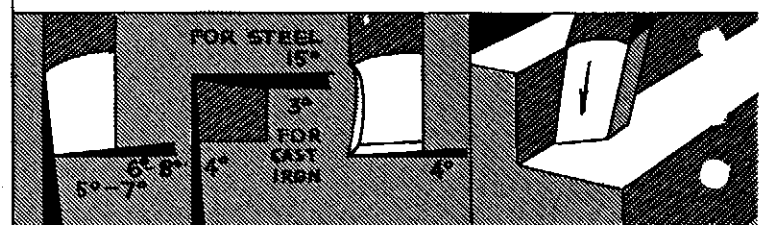

ROUND-NOSED TOOL FOR LIGHT FINISHING CUTS ON STEEL

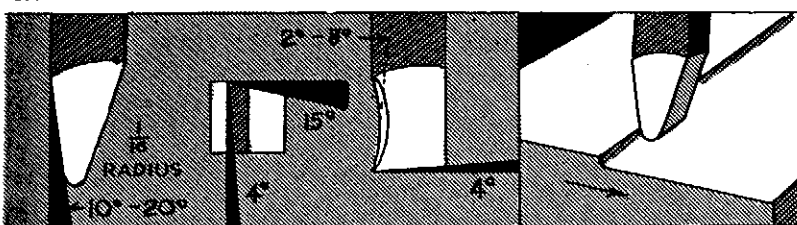

ROUND-NOSED TOOL FOR BRONZE OR BRASS

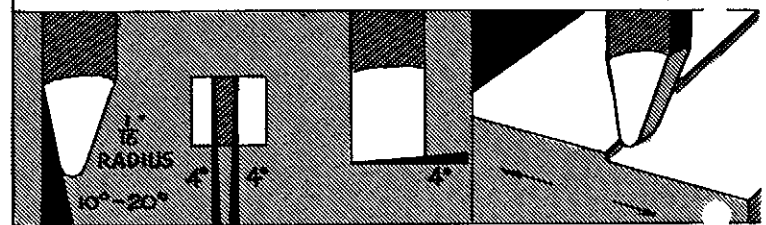

SHEAR TOOL FOR FINISHING STEEL

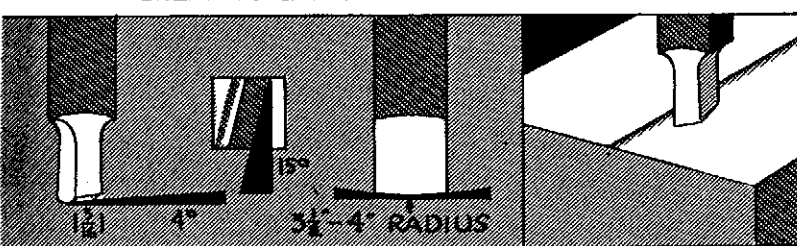

CUTTING-OFF AND SLOT-CUTTING TOOL

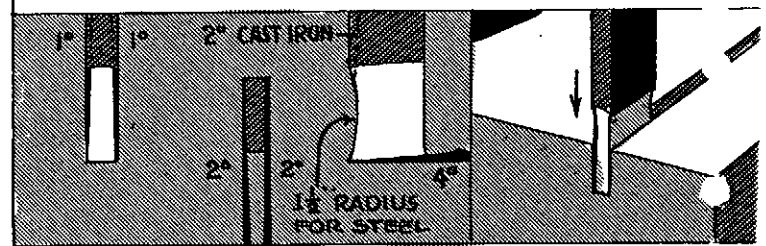

FIG. 248

HOW TO SET UP SHAPER TOOLS

Unit 1-P52(C) Part I Pages 167 to 172



Photo by courtesy of J. H. Williams & Co.

UNIVERSITY OF THE STATE OF NEW YORK
STATE EDUCATION DEPARTMENT
BUREAU OF INDUSTRIAL AND TECHNICAL EDUCATION

HOW TO SET UP SHAPER TOOLS

OBJECTIVES OF UNIT

1. To explain how the tool head is prepared, and how the tool and tool holder are selected.
2. To show how the tool and tool holder are set, and to illustrate a number of typical tool setups.

INTRODUCTORY INFORMATION

An important element in tool setting is one of rigidity. The tool head is provided with adjustments to eliminate vibration as much as possible, and at the same time to allow for the movement of the tool. To minimize the tendency toward vibration or chatter, the head, then, should be properly adjusted. In addition, the tool must be supported properly. The tool slide and tool should not be allowed to overhang or project beyond the point of support any more than is absolutely necessary. The tool also must be held short in the tool holder. There are times, however, when overhang is unavoidable. In these cases, light cuts should be taken and care should be observed when the tool is being fed into the work.

Another important consideration is to set the tool or holder so that the tool swings away from the work. The importance of such a setting is evident when a flat surface is being roughed out. If the tool is held in a vertical position and the side pressure of the cut causes the tool or holder to move in the tool post, the tool will swing away from the surface being machined. If, on the other hand, the tool or tool holder is pointed toward the cut and the side pressure of the cut causes the tool or holder to move in the tool post, the tool will "dig in." Here again, there are exceptions to this rule. If it is necessary to point the tool toward the cut, the tool must be watched carefully to see that it does not slip and dig into the work.

Finally, the tool may be set ahead or behind the point of support. In many cases the tool can be set ahead of the point of support. For finishing cuts, the tool may be set behind the supporting surface, the double purpose being to eliminate chatter and to produce a smoother finish.

TOOLS AND EQUIPMENT

Shear tool	Tools for cutting contours
Cleaning cloth	Shaper and necessary wrenches
Tools for serrating	Tools for combined and vertical cuts
Available tool holders	Tools for side cutting and chamfering
Tools for cutting slots	Tools for horizontal and vertical cuts

HOW TO USE SHAPER TOOLS

PROCEDURE

PREPARATION OF THE TOOL HEAD

1. Read the description of the tool head on page 14.
2. Clean and oil the head daily, following the instructions given on page 48.
3. Examine the clapper box and make sure that dirt, burrs, or chips do not prevent the block from working freely.
4. Be sure that no chips have lodged between the back of the block and the base of the clapper box. This would prevent the block from seating properly.
5. Move the block outwards and upwards with the hand and allow it to drop back into place.
6. Be sure that it seats solidly on its base.
7. Move the tool slide up and down by turning the down-feed crank.

NOTE: The gib on the tool slide should be adjusted so that the down-feed crank offers resistance to turning when the tool slide is moved downwards.

CAUTION

Some experience, care, and judgment are necessary when the gib is being adjusted. The regulating should be done by a qualified person.

SELECTION OF THE TOOL OR TOOL HOLDER

1. Read the description of tools and tool holders on pages 153 and 158.
2. Decide whether a solid forged tool or a tool holder must be used, basing the decision on the job to be machined and the available supply of tools and tool holders.
3. Observe whether the tool is held parallel with the shank of the tool holder or is inclined at an angle if a tool holder is used.
4. Be sure that the clearance and the rake of the tool are ground to suit the manner in which the tool is held in relation to the shank of the tool holder.

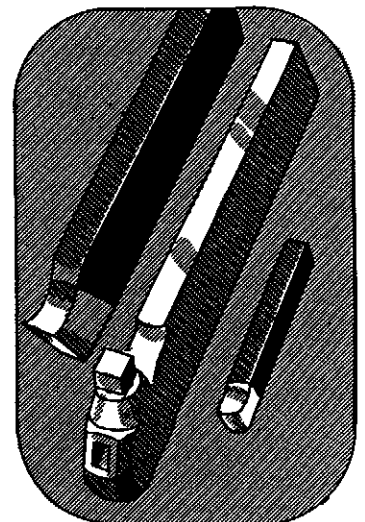
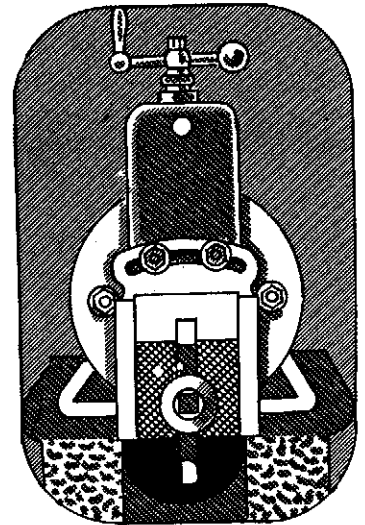

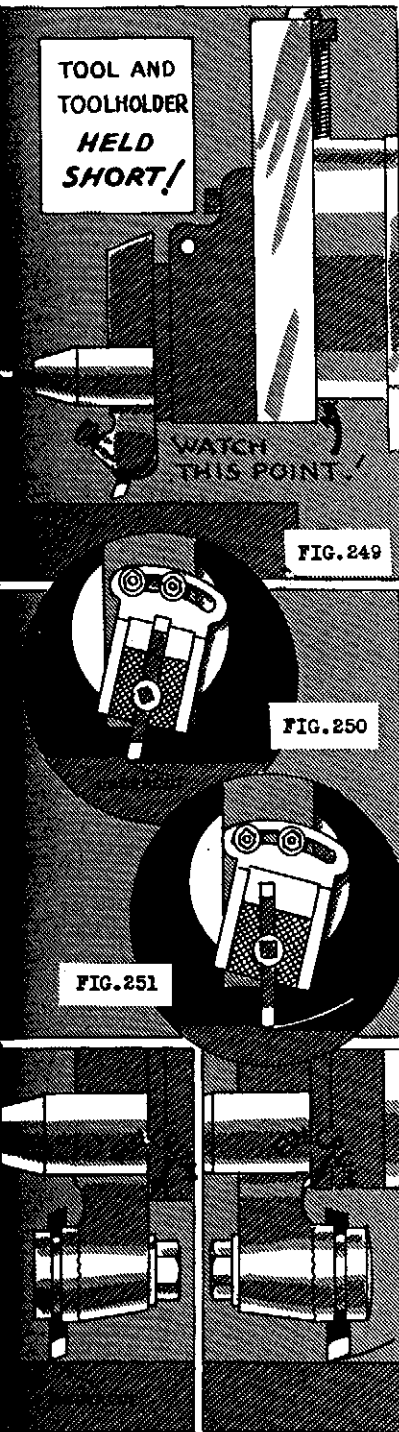

Remember that the inclination of the tool affects both the clearance and the rake as explained on page 165.

5. Choose from the special set (Fig. 214), if a set is available, a tool to suit the character of the work. These tools are ground with the correct clearance and rake, and the cutter can be changed easily to meet the requirements of the work.

SETTING THE TOOL OR TOOL HOLDER IN THE TOOL POST

1. Adjust the tool slide with the down-feed crank so that when additional cuts are taken the tool slide will not project or overhang more than one inch below the head of the ram (Fig. 249).

NOTE: Sometimes it is necessary to move the slide beyond the limit of one inch for some cutting operations. If this is necessary, light cuts should be taken and care should be exercised; otherwise the tool slide may be broken.

2. Move the clapper box to the right (Fig. 251) if the tool is cutting on the right-hand side of the work. This will allow the tool to move clear of the work and will prevent unnecessary wear on the cutting edge of the tool. (Refer to page 179 for setting the clapper box.)
3. Move the clapper box to the left if the tool is cutting on the left-hand side of the work.
4. Set the clapper box in a vertical position for cutting off, for cutting slots, and for making similar cuts.
5. Move the head either to the right or to the left for angular cuts.

NOTE: The adjustment of the clapper box to the right or to the left will depend upon the direction of the cut, whether the cut is on the right or left side of the work, and the direction in which the head is swiveled. These adjustments are fully explained in the following units.

6. Hold the tool short in the tool holder (Fig. 249).
7. Place the tool holder or tool in the tool post with the small-

est possible amount of overhang (Fig. 249). The reasons for this are to secure the tool rigidly, to prevent chatter in the tool, and to prevent undue strain on the tool slide.

8. Place any one of the tools in the shaper tool post in the conventional manner. (Fig. 252). Notice that the cutting edge of the tool is ahead of the support or fulcrum.
9. Reverse the tool holder illustrated in Fig. 253 if a gooseneck tool is desired. This has the cutting edge behind the support to allow the tool to swing away from the work when it is under heavy cutting pressure. (Refer also to page 155.)

NOTE: The tool holder shown in Fig. 208 is still used in some shops, although it is being gradually replaced by the one illustrated in Fig. 209.

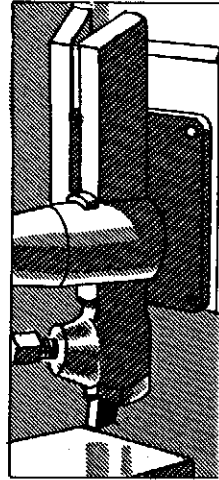

HORIZONTAL CUTS

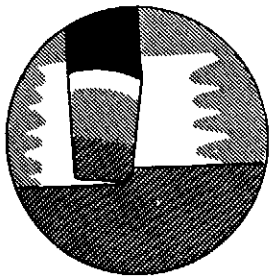

1. Tool head vertical.
2. Clapper box vertical or over to the left.
3. Tool or tool holder held vertically.

1. Tool head vertical.
2. Clapper box vertical or over to the right.
3. Tool or tool holder held vertically.

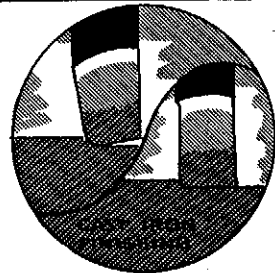

VERTICAL CUTS

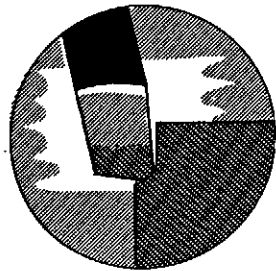

1. Tool head vertical.
2. Clapper box over to the left.
3. Tool holder inclined to give about 5° clearance on the side.

1. Tool head vertical.
2. Clapper box over to the right.
3. Tool holder inclined to give about 5° clearance on the side.

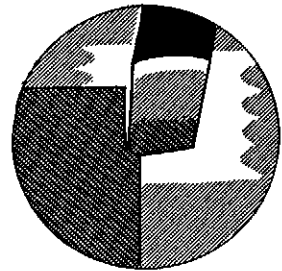

COMBINED CUTS

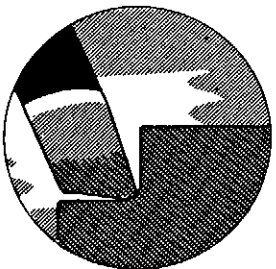

1. Tool head vertical.
2. Clapper box over to the left.
3. Tool set to have about 5° clearance with the vertical and the horizontal sides.

1. Tool head vertical.
2. Clapper box over to the right.
3. Tool set to have about 5° clearance with the vertical and the horizontal sides.

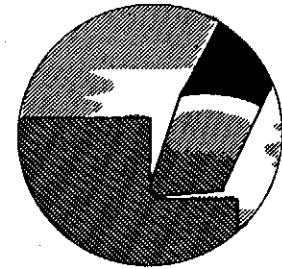

ANGULAR CUTS

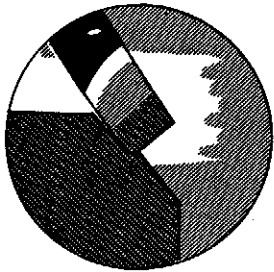

1. Tool head set to the left.
2. Clapper box over to the right.
3. Tool set to have about 5° clearance with the angle of the cut.

1. Tool head set to the right.
2. Clapper box over to the left.
3. Tool set to have about 5° clearance with the angle of the cut.

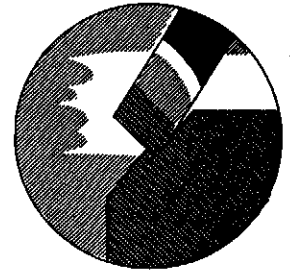

CHAMFERS

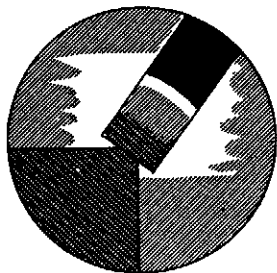

1. Tool head set to the right.
2. Clapper box parallel with the head.
3. Tool edge set approximately with a gage, or with a protractor.

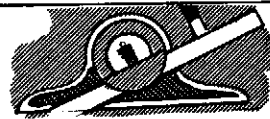

1. Tool head set to the left.
2. Clapper box parallel with the head.
3. Tool edge set approximately with a gage, or with a protractor.

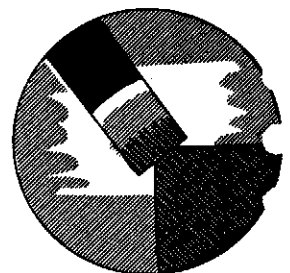

CHAMFERS

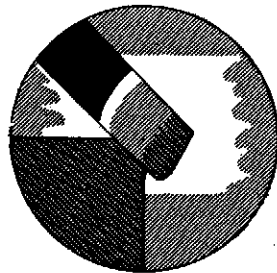

1. Tool head vertical.
2. Clapper box to the right.
3. Tool edge set approximately with a gage, or with a protractor.

1. Tool head vertical.
2. Clapper box to the left.
3. Tool edge set approximately with a gage, or with a protractor.

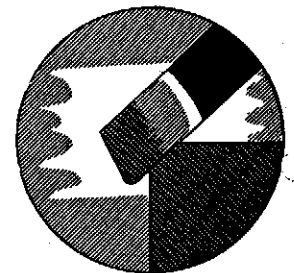

SLOTS

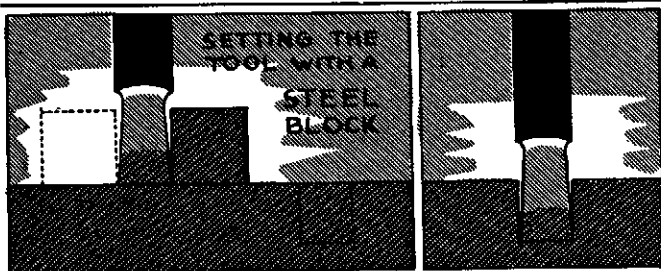

1. Tool head vertical.
2. Clapper box vertical.
3. Tool set with a horizontal surface and side of the tool set with a steel block or a small square.

SERRATIONS

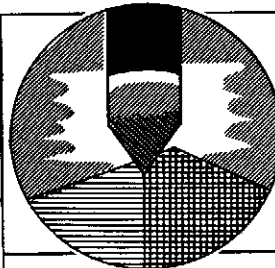

1. Tool head vertical.
2. Clapper box vertical.
3. Tool vertical.

FORM CUTS

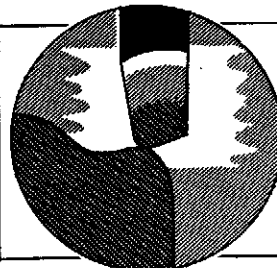

1. Tool head vertical.
2. Clapper box vertical.
3. Tool vertical.

DESCRIPTION OF HORIZONTAL, VERTICAL AND COMBINED CUTS

Unit 1-T53(A) Pages 173 to 188

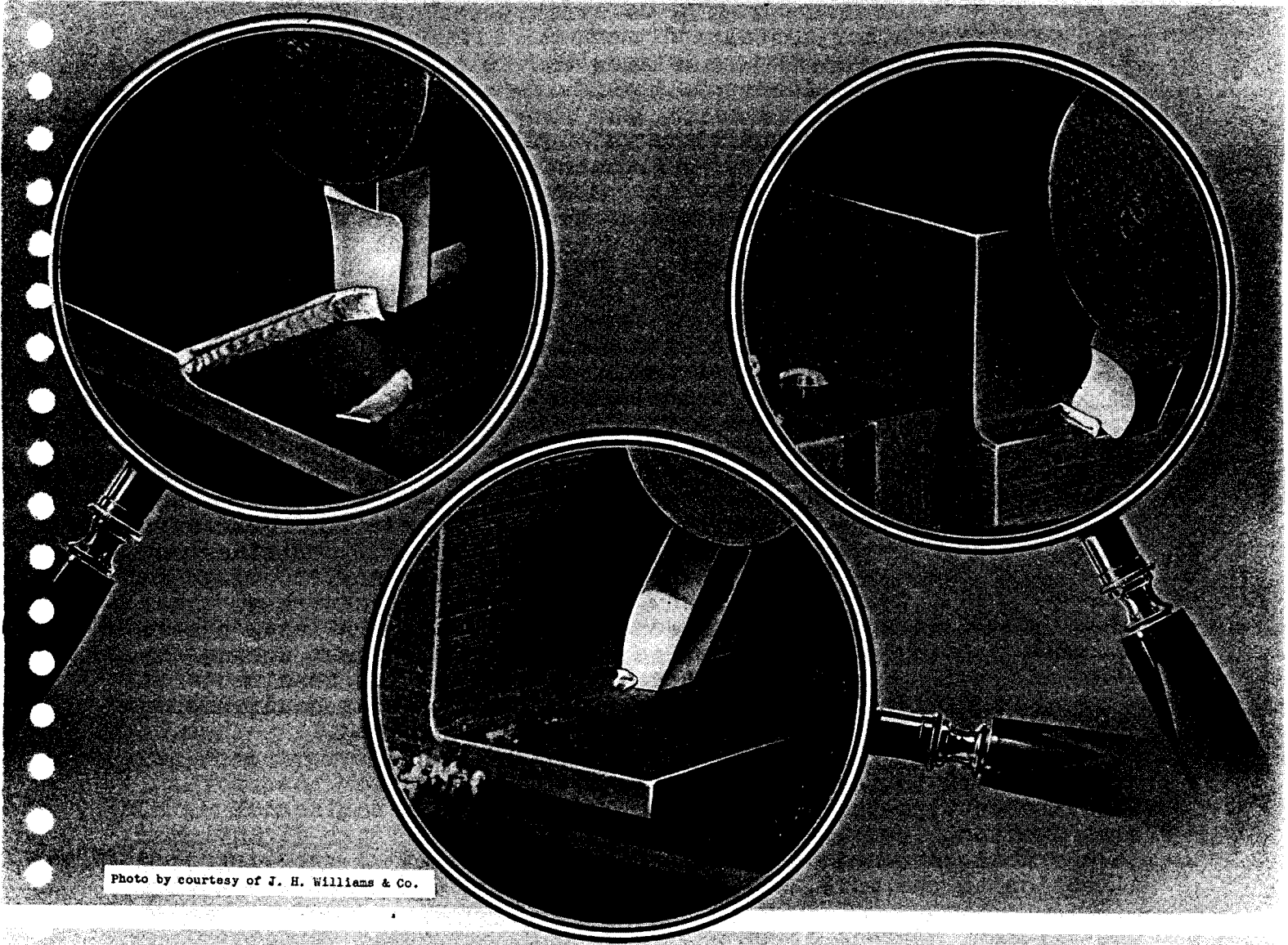

Photo by courtesy of J. H. Williams & Co.

UNIVERSITY OF THE STATE OF NEW YORK
STATE EDUCATION DEPARTMENT
BUREAU OF INDUSTRIAL AND TECHNICAL EDUCATION

DESCRIPTION of HORIZONTAL, VERTICAL and COMBINED CUTS

OBJECTIVES OF UNIT

1. To describe horizontal and vertical cuts.
2. To describe shoulder cuts.
3. To point out the requisites of a good setup.
4. To discuss the factors which affect surface finish.

INTRODUCTORY INFORMATION

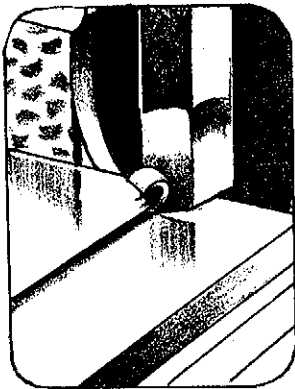

Most of the work performed in the shaper consists of machining flat surfaces on work held in one or another of the devices already described.

A single-point tool, so called because it has one cutting edge, does the cutting. It moves back and forth over the work with a reciprocating movement, cutting during the forward stroke only. During each return stroke either the work or the tool is advanced (fed) more or less, preparatory to removing another cut during the next forward stroke. The feeding is continued automatically, or by hand, un-

til a surface of the desired width has been machined.

When the work is fed in a horizontal direction under the reciprocating cutting tool, the surface produced is a horizontal flat surface. But when the work is fed in a vertical direction to the tool, or when, instead, the tool is fed in a vertical direction to the work, a vertical flat surface is produced.

The vertical surface or step joining one horizontal surface with another horizontal surface which is somewhat higher or lower is referred to as a shoulder. Both horizontal and vertical shaping are required to form a shoulder when the distance separating the horizontal surfaces is considerable.

The surface finish attained depends on such factors as the shape of the tool, the depth of cut, the rate of feed, and the material being machined.

DEFINITION OF CUTS

In the subsequent description of shaper operations, the word "cut" recurs frequently. The same meaning, however, is not attached to this word in each instance, as the following examples will indicate.

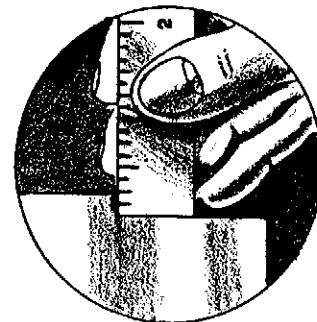

The most common usage of the word has reference to the thickness of the metal which the tool removes from the surface of the work and indicates the depth of the shoulder which is made by the tool when it is cutting the metal. For example, when, according to instructions, a 1/4-inch cut is to be made, 1/4" of metal is removed from the surface, and the thickness of the work is reduced a corresponding amount. During the cut the tool forms a shoulder one-fourth-inch deep as indicated by a measurement taken from the finished surface to the uncut surface of the work.

The term "cut" is used in another sense in calculating the time required to machine a given area. In this instance, "cut" refers to the width of the surface from which the metal is removed, for the work is usually placed in the shaper lengthwise. Then, with the feed per stroke known, the width of the surface determines the number of strokes required to take a cut off the surface. For example, if one-fourth inch of metal is removed from a surface 6" wide and 10" long, and the work placed in the machine lengthwise, the width of the surface would be referred to as a 6-inch cut, for the tool would be required to feed a total of 6" to finish the surface. The number of strokes required to machine the surface depends upon the rate of feed.

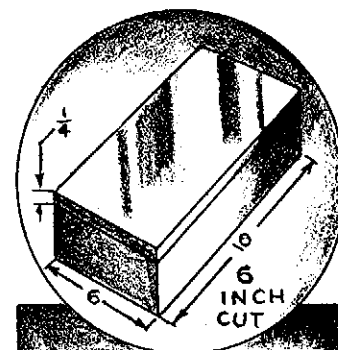

The word "cut" is used in still another sense to designate the plane of the surface from which the metal is removed. For example, when the surface requiring machining lies flat, and the work is fed under the tool in a horizontal direction, the tool is said to take a horizontal cut.

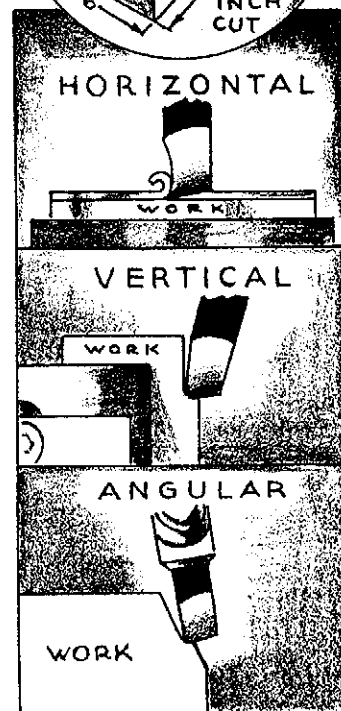

The same procedure is followed in referring to metal removed from a surface located in a vertical or an angular plane. Thus, when the tool is fed down or the work is fed up at right angles to the top of the table, the cut is said to be a vertical cut. When the tool head is swiveled from its 90° location, and the tool is subsequently fed to the work by means of the down-feed screw, the result is an angular cut.

THE HORIZONTAL CUT

The horizontal surface, as produced in the shaper, is the result of a series of cuts made with a single-point cutting tool during the forward stroke of the ram and the accompanying movement (feeding) of the work in a horizontal direction during each return stroke. Alternate cutting and feeding are continued until a surface of the desired width has been machined, the feeding being either automatically or manually controlled. During the cutting process, the work is clamped rigidly in a vise, in a fixture, or to the surface of the table, its only movement occurring together with the movement of the table on the cross rail, when the cross-feed screw is turned.

With the exception of unusual conditions which require that the feeding mechanism operate at the beginning of the cutting stroke instead of during the return stroke, the length of stroke should be set only about three-fourths of an inch longer than the work. One-half inch of this extra length should come at the beginning of the stroke in order that the clapper block may seat properly before the tool engages the next cut; the remaining one-fourth inch should come at the end of this stroke.

PLACEMENT OF THE STROKE

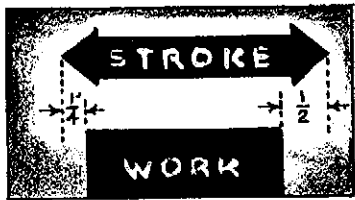

When, for one reason or another, the feed has been adjusted to operate at the beginning of the stroke, the tool must be allowed to run beyond the back end of the work a somewhat greater distance than usual, and obviously the stroke too must be made correspondingly longer. The additional space is required at the beginning of the stroke under these conditions in order that all feeding of the table will have been completed

before the tool engages the metal; otherwise the feed mechanism will be subjected to the heavy pressure needed to force the tool into the metal, a pressure which the mechanism never was intended to withstand.

Although it is essential that the ram stroke be somewhat longer than the work and that the stroke be placed so that the cutting tool clears both ends of the work, the tool, nevertheless, is idle (non-cutting) as it passes through this extra space, inasmuch as it removes no metal at this time.

For economy of time, therefore, it is important that the stroke-length be held to the minimum required for proper functioning of the tool, and, moreover, that the work be placed in the shaper, whenever practicable, in a manner intended to reduce the non-cutting or waste time of the tool to a minimum. Despite the desire for economy of time, however, the stroke should not be shortened to the extent that the feed mechanism is caused to operate after the tool has entered the cut.

PLACEMENT OF THE WORK

Since it is necessary for the tool to overrun the work for the same distance, whether the stroke used is long or short, it becomes apparent that the job should be placed in the machine in the position requiring the fewest strokes, for less time will then be wasted. Thus, when a surface may be planed either crosswise with a short stroke or lengthwise with a longer stroke, the longer one should be selected. For example, a job which can be machined by placing it in the shaper either lengthwise or crosswise has been shown in Fig. 254. If this job is placed in the shaper crosswise the non-cutting area traveled by the tool will be twice as great as that which the tool would travel if the job were placed in the machine lengthwise. The non-cutting area for the crosswise cut is represented in grey; for the lengthwise cut it is represented in black.

In conformity to the practice recommended, that of placing the work in the shaper lengthwise whenever practicable, the work held in the vise should be gripped by its longer sides and the vise jaws should be set parallel with the ram as shown in Fig. 255. Narrow work should not be held in the vise as shown in Fig. 256 since it is likely to turn under the cutting pressure.

All work, however, cannot be planed with a lengthwise stroke. It is often expedient when extremely heavy cuts are being taken and when the work has only a small gripping surface, to set the vise jaws at right angles to the ram and to use a shorter crosswise stroke. With this arrangement, the work is less likely to slip in the vise, for the thrust of the tool during the cut is taken up by the vise jaw.

TOOLS FOR THE HORIZONTAL CUT

Tools of various shapes and tools for various cuts and materials have been described and illustrated in the section entitled, Description of Shaper Tool Holders and Shaper Tools, beginning on page 151.

For horizontal cuts intended to remove excess metal when the surface finish is of minor importance, one of the round-nosed roughing tools illustrated on page 166 in the above section will prove very satisfactory. When the selection is made, both the material in the job and the direction of the feed must be taken into consideration. The material to be cut influences the top- and side-rake angles of the tool particularly, and the direction of the feed determines whether a tool having its cutting edge on the right

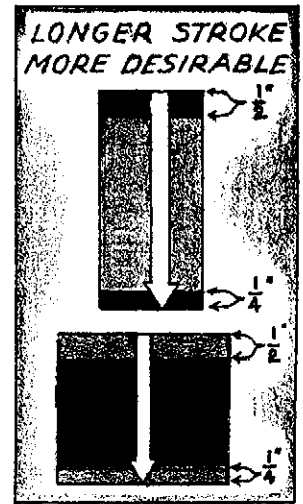

FIG. 254

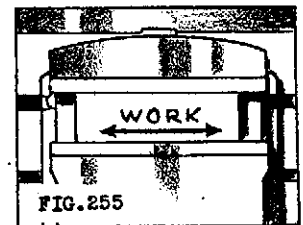

FIG. 255

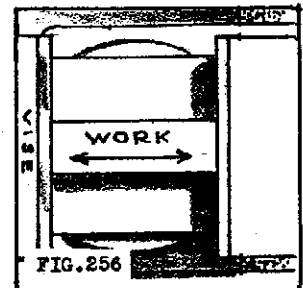
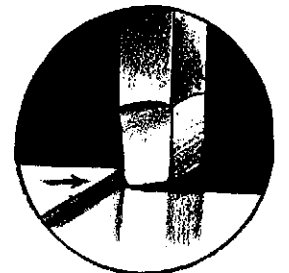

FIG. 256



side, or one having its cutting edge on the left side will be used. The cutting edge, obviously, should be on that side from which the work approaches the tool during the cut. For example, a tool ground approximately like the one in Fig. 248 should be used for roughing out a horizontal surface of cast iron, and the work should be fed to the tool from the left side, since the cutting edge is on the left side of the tool.

Either a solid tool, forged and then ground to the recommended shape, or a tool bit ground to a similar shape and held in a suitable tool holder, can be used. For extremely heavy cuts, the solid tool is preferred.

REQUISITES OF A GOOD SETUP

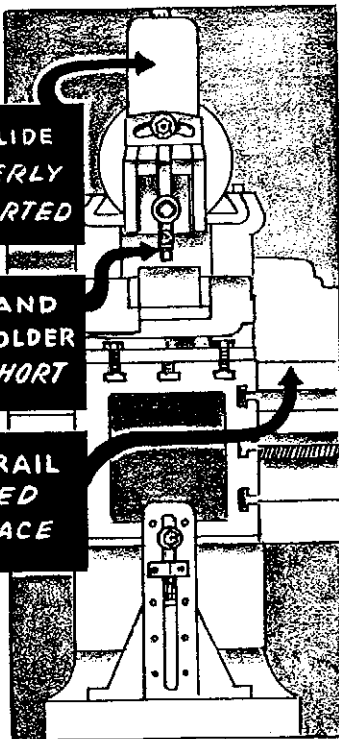

FIG. 257

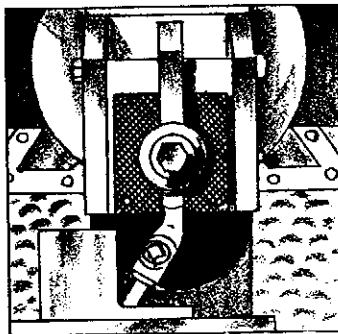

FIG. 258

Rigidity of both the machine and the cutting tool is essential for the taking of heavy cuts and for the production of accurate work in the shaper. One of the requisites for attaining a rigid setup is the proper placement of the cross rail on the column; another has to do with the placement of the cutting tool, and a third with the position of the tool slide on the head (Fig. 257).

Whenever practicable, the cross rail should be moved up on the column so that the surface to be planed is about two inches below the ram. Of course, the binder bolts which clamp the rail to the column and also those which clamp the table support must be loosened before the rail is adjusted and, likewise, after the rail has been relocated, these bolts should be tightened again.

The tool bit, if one is used, should extend from its holder only far enough to allow the cut to be made without interference between the work and the tool holder. The tool holder, also, or the forged tool, whichever is used, should be clamped in the tool post with its cutting end fairly close to the tool head so that it will be well supported.

Moreover, the tool slide should be kept well up on the tool head where it too will be properly supported. Incidentally, allowing the slide to extend more than 1-1/2 inches beyond the head is considered extremely hazardous since it is likely to break from the pressure

of the cut. Too great an extension of the tool slide and the hazards which accompany it, however, are likely to occur only when the admonitions regarding the location of the rail on the column and the clamping of the tool in the tool post have been disregarded. If both the rail and the tool are located as suggested, it will be practically impossible to move the slide too far down on the head during the cut.

When, for one reason or another, the surface to be planed cannot be raised so that it is close to the ram, the extra space should be provided for in the setting of the tool; that is, the tool should be extended from the tool post, rather than the tool slide from the head (Fig. 258).

When a cut is taken from a horizontal surface, the tool head, the clapper box, and the cutting tool are usually placed in a vertical position, that is, perpendicular to the surface to be planed.

The only reason for setting the head vertically, that is, with the 90° graduation on the swivel block in line with the zero on the ram, is that with the head in this position, vertical movement of the tool coincides exactly with that registered on the micrometer dial located on the down-feed screw.

On the other hand, if the head is set at an angle other than 90° , the actual vertical movement of the tool will be somewhat less than the distance indicated on the graduated dial, inasmuch as the tool is then moved toward the work in an angular direction instead of in a vertical direction when the down-feed handle is turned (Fig. 259).

POSITION OF THE CLAPPER BOX

The function of the clapper box is to permit the tool to lift during its return stroke and thereby prevent severe rubbing of the tool on the metal and the consequent dulling of its cutting edge. The clapper box is usually set square with the head during horizontal cuts, although for heavy cuts it may be desirable to swing its upper end away from the cut in order to relieve the tool from excessive drag. When the clapper box is swiveled, the tool not only lifts but also swings out from the work during the return stroke. The manner in which this action takes place has been more fully explained on page 186 in connection with vertical shaping.

If the clapper block is to function as intended, it

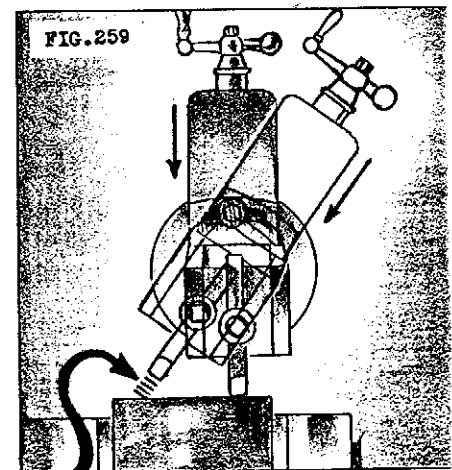

ADDITIONAL DISTANCE
SLIDE MUST TRAVEL TO
REACH SURFACE —

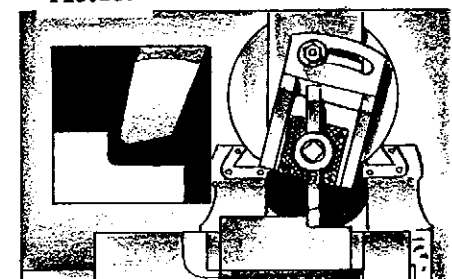
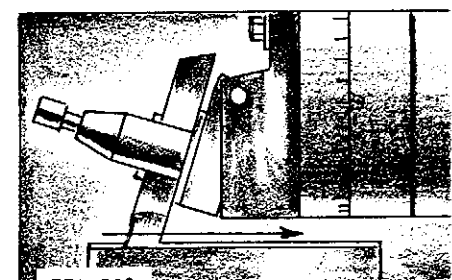

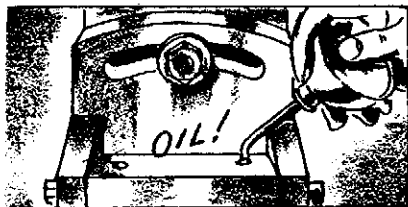

must be maintained in good operating condition by keeping it clean, properly adjusted, and well oiled. The lubrication will assure the block's lifting freely during the return stroke, and cleanliness, together with careful adjustment of the taper pin on which it hinges, will assure proper seating of the block during the cutting stroke.

PLACEMENT OF THE TOOL HOLDER AND THE TOOL

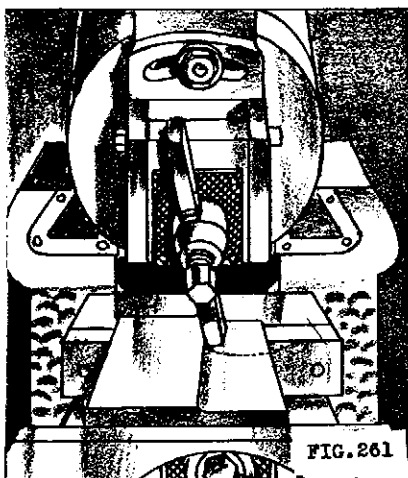

FIG. 261

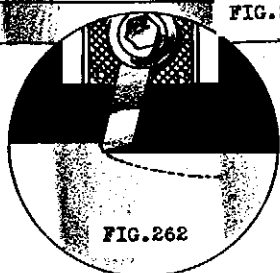

FIG. 262

The cutting tool should be clamped securely in the tool post in a vertical position approximately square with the surface to be planed. During heavy cuts when the pressure of the metal on the tool is likely to move the tool sidewise, the tool should be set at a slight angle away from the work, so that if by any chance the tool moves, it will be in a direction away from the work as shown by the arc in Fig. 261. If the tool is pointed toward the work and cutting pressure moves it sidewise, its movement will be in the direction indicated by the arc in Fig. 262. The cut then, obviously, will become deeper and, if unobserved, this downward movement of the tool may result in planing below the finish line and thus cause the work to be spoiled. When, for any reason, the tool must be pointed into the cut, it must be watched very closely in order to detect, immediately, any slippage which might occur. The farther the tool extends from the tool post, the greater becomes its likelihood of moving because the pressure on its end increases in proportion to its extension from the tool post. For most work, the tool need not extend more than 1-1/2 inches below the tool block.

DIRECTION OF THE FEED

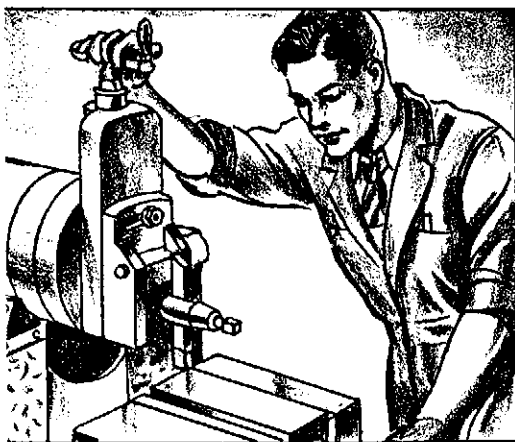

FIG. 263

During the operation of the shaper, the operator usually occupies a position at the right-front side of the machine. From this position most levers and handles which are used for setting up the job and the machine, as well as levers and controls used for subsequently operating the machine during the cut, are accessible to the operator without his moving any appreciable distance.

The logical place to start the cut, therefore, is from the right side of the work, that is, from the side nearest the operator. From his usual place, the operator is then able to ob-

serve the depth of the cut and the cutting action of the tool during the cut. A tool with its cutting edge on the left side must be used for cuts started on the right side of the work. The tool is set to the depth of cut desired by means of the down-feed handle, and this depth of cut is indicated in thousandths of an inch on the micrometer dial adjacent to this handle (Fig. 263).

The work is fed to the tool by hand until the cut has been started and until its correct depth has been established; only then is the power cross feed engaged (Fig. 264).

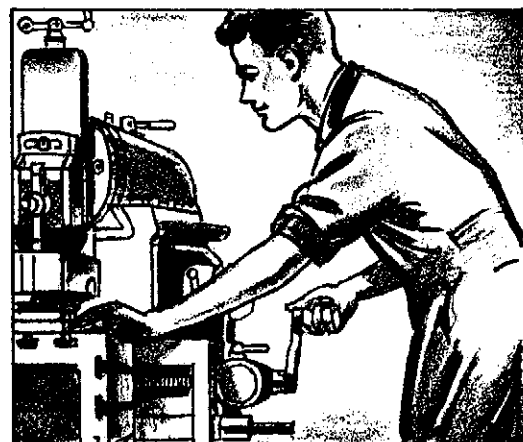

FIG. 264

THE ROUGHING CUT

A roughing cut is one made primarily for the purpose of preparing the surface of the work for the final or finishing cut, the appearance of the surface being of minor importance.

Roughing cuts may consist merely of removing one or two cuts in order to remove scale and irregularities found especially on the surface of castings, with the idea of making the surface fairly straight and level preparatory to taking the finishing cut.

They may, on the other hand, consist of taking several heavy cuts when considerable excess metal is to be removed prior to finishing the surface.

In either case, to avoid rapid dulling of the cutting tool, the first cut taken from a casting should be sufficiently deep to get under the scale, provided a cut of this thickness can be made without cutting the work undersize.

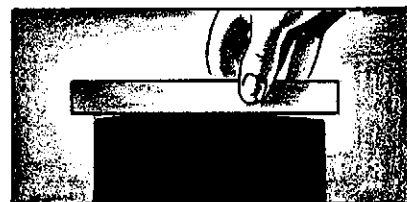
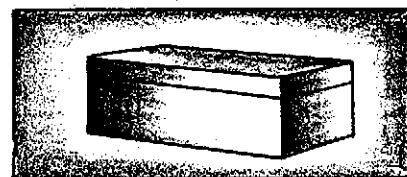
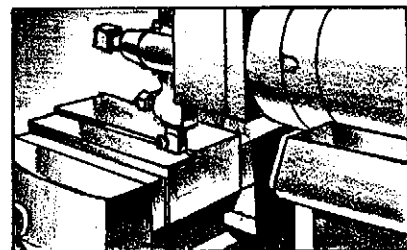
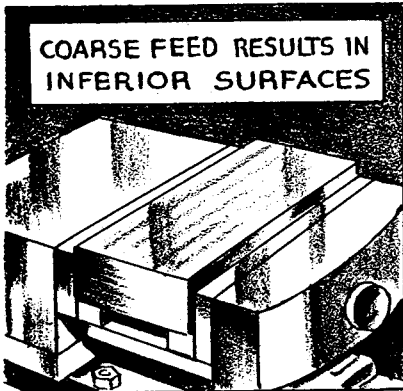

FIG. 265

If the job requires no great accuracy or fine finish, one cut made with a moderate rate of feed may suffice. Since the surface of a rough casting is seldom straight or level, the cut will not be of uniform thickness throughout, but the tool will remove a thick chip from high points on the casting and a thin chip from the low spots. This variation in the depth of the cut is reflected to some extent in the machined surface, for the tool springs more when taking a heavy cut than it does when making a light cut, and, as a result, produces a surface on which high and low spots are quite apparent when the surface is checked with a straight edge.

Therefore, whenever the final surface is to be straight, a second



roughing cut is recommended, and approximately $1/16''$ of metal should be allowed for this cut in addition to the amount usually allowed for the finish cut.

When considerable metal is to be removed, the depth of the roughing cut and the rate of feed should be combined to remove as much of the surplus stock during a single cut as the shaper is capable of removing, always subject to the condition that the job, the method of holding it, and the size of the tool can withstand the pressure exerted by a heavy cut and a coarse feed.

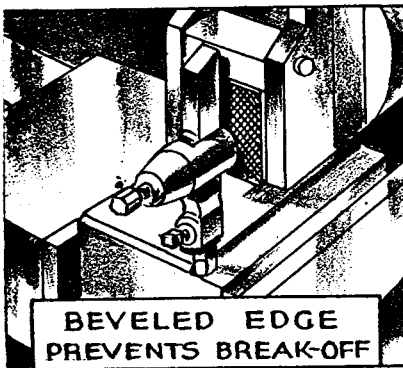

Roughing cuts for removing a given amount of surplus metal can be made by using either a very coarse feed and less depth of cut or by using a heavy cut and less feed per stroke. The deeper cut with less feed is usually preferable, inasmuch as the wide spacing of the feed marks and the greater tear in the metal which accompany the very coarse feed, result in an inferior surface which consequently requires a greater number of finish cuts to produce a smooth surface of good appearance.

As a general rule, it is best first to set a rate of feed which will result in a surface having the desired finish, and then to set a depth of cut suitable to the job, the tool, and the power of the machine.

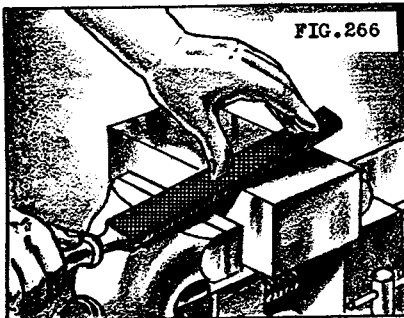

The edge at the end of the cut, especially on cast materials, is likely to break off, leaving the edge ragged. This undesirable condition can be avoided by beveling the edge about 45° , approximately to the depth of the intended cut, using a file, or a cold chisel if considerable material is to be removed.

THE FINISHING CUT

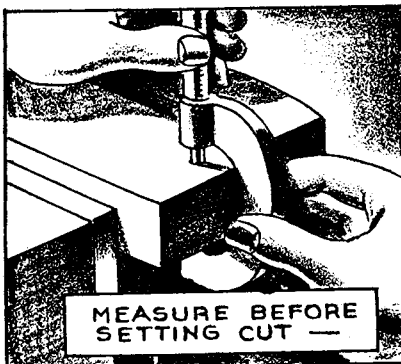

A finishing cut is one made for the purpose of cutting the work to size and at the same time giving it a smooth surface of good appearance.

The amount of material which must be removed to produce the required finish on a job is dependent upon the surface produced during the last roughing cut. Ordinarily, the feed marks and tears caused by the roughing tool can be removed from the work if between ten and fifteen thousandths are allowed for the finishing cuts. If, however, the feed used during the final roughing cut was exceptionally coarse

or if the tears caused by the tool during this cut are unusually deep, the amount of material allowed for the finishing cuts must be increased, provided the size of the job is to be accurately maintained.

The number of finishing cuts required will be determined largely by the kind of finish desired and by the degree of accuracy demanded, and not by the amount of metal which is to be removed.

For example, when neither the final dimensions nor the finish specified on the job are too exacting, one finish cut made with the same tool used for roughing, but with the feed reduced somewhat, may produce the desired results. On the other hand, several cuts will be required if the surface is to be perfectly true and if the dimensions are to be extremely accurate at the same time.

The tools used for roughing cuts made on steel and cast iron are quite similar in shape, although different side- and top-rake angles are recommended for tools used for each of these materials. The tools used for finishing these materials, however, differ considerably and should not be used interchangeably. (Refer to page 166.)

The tool best suited for finishing cast iron has a rather broad and flat cutting edge ground at right angles to the stroke of the ram. This cutting edge must be set parallel with the surface of the work so that a feed approximately one-half the width of the cutting edge may then be used. In this way, one cut overlaps the next considerably and produces a smooth surface (Figs. 267 and 268).

When broad surfaces on cast iron are being finished, it is not unusual to use a tool having a cutting edge $3/4$ " to 1" in width. Because of its broad contact with the work, however, "chatter" and "digging in" are likely to occur. These objectionable consequences can be eliminated by setting the cutting edge of the tool directly under, or, preferably, a short distance behind the fulcrum A. In solid tools, this is accomplished by shaping the tool as shown in Fig. 269. This tool is known as a spring tool and for obvious reasons also as a "gooseneck" tool. The same effect (spring) can be obtained with certain kinds of tool holders by placing them in the tool post as shown in Fig. 205 on page 155.

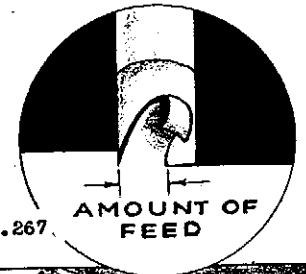
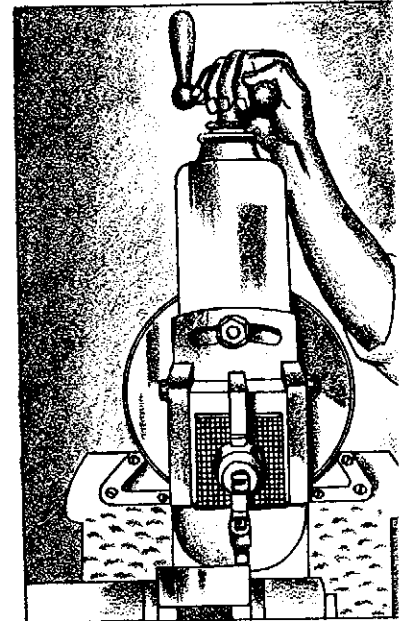

FIG. 267

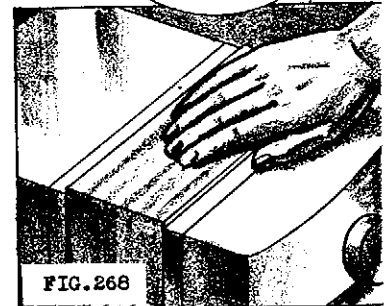

FIG. 268

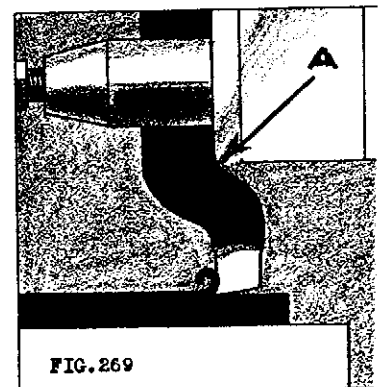
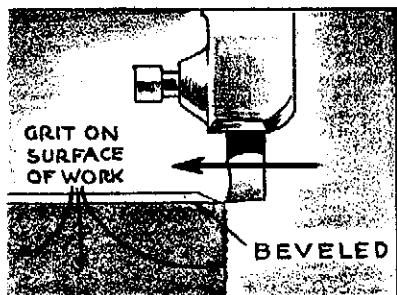
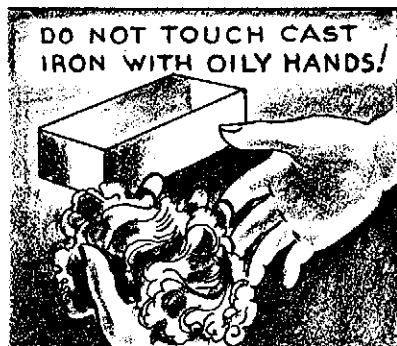

FIG. 269



Finishing tools used on cast iron will remain sharp for a longer period if the edges of the castings are beveled slightly so that the tool will not come into contact with the sand and scale usually present on their surfaces.

Oil, too, should be kept from cast iron, especially during finishing cuts, for when oil is present the tool glazes the surface and, as a result, slides over the metal instead of penetrating it.



Steel offers a greater resistance to cutting than does cast iron, and for this reason the broad-nosed tools and the coarse feeds generally used in the finishing of cast iron, cannot be used for finishing steel, for these tools tend to gouge or "dig" into the surface.

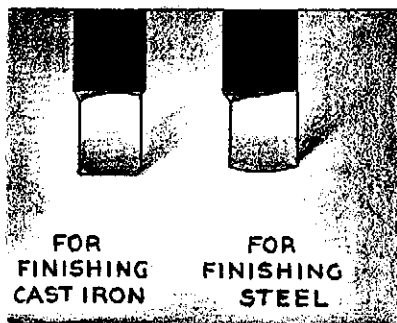

The width of the flat cutting edge, therefore, is considerably less on a tool used for finishing steel than on one used for finishing cast iron. Furthermore, in contrast with the cutting edge of the tool used for cast iron, the cutting edge of a finishing tool for steel should be ground so that it approaches the work at an angle, and takes what is known as a shear cut. A shear tool produces a very smooth surface if used with a fine feed and a suitable cutting lubricant. Moreover, if the cutting edge is set behind the fulcrum as has been suggested for the cast-iron finishing tool, all possibility of its "digging in" can be eliminated. (Refer also to page 166.)

THE VERTICAL CUT

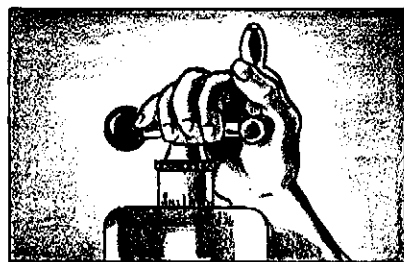

Vertical cuts are used for squaring the ends of long work, for squaring shoulders, for cutting slots and keyways, and for planing other work of a similar nature.

There are two ways in which a vertical surface can be planed in the shaper. In the first, and by far the most frequently used method, the tool is fed to the work in a downward direction by means of the down-feed screw and under the guidance of the tool slide.

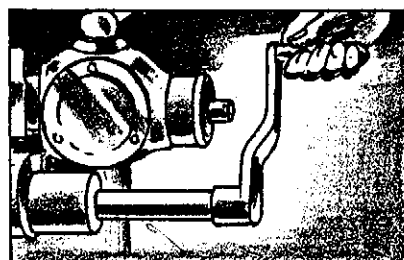

In the second method, the work is fed to the tool in an upward direction by means of the elevating screw — the cross rail, the table and the work being moved up on the ways of the column as a unit (Fig. 270).

In order that the operator may be fairly certain that

FIG. 270

an end or a shoulder will be machined square with both a side and the base of the job, these two locating surfaces must have a definite relationship with the stroke of the ram and with the upper surface of the machine table, respectively. For example, the side which is to be square with the end must be located at right angles to the stroke, and the base must be parallel with the top of the table.

To meet these requirements, the work can be placed either on parallels in the machine vise having its jaws set square across, or it can be placed crosswise on the machine table and squared with the side of the table. Moreover, as a precaution against cutting into the vise or the table, the work should be extended at least one-eighth inch farther beyond the side of the work-holding device than is necessary for cutting the work to length (Figs. 271 & 272).

In order to complete the setup for planing an end or a shoulder, the tool slide, the tool, and the clapper box must be correctly adjusted also. When the down-feed method is used, the tool slide must be set square with the table, for this setting determines the direction of the tool during the cut. When, however, the vertical cut is made by feeding the work to the tool by raising the table, the setting of the slide is of minor importance, inasmuch as the work is guided vertically by the ways on the column.

Either a straight or an offset tool holder (or a solid tool) can be used with equal facility for vertical cuts, provided that the tool bit used in each of these holders is ground accordingly and that the tool holder is held in position correctly in the tool post.

Best results are achieved when the cutting edge of the tool is set in an approximately horizontal plane. In order to obtain this condition when a straight tool holder is used, the cutting edge must be on the end of the tool bit and the tool holder must be set at a slight angle in the tool post so that it will clear the work when the tool is fed down (Fig. 274).

On the other hand, when an offset tool holder is used, the cutting edge must be on the side of the tool bit instead of on the end, if the cutting edge is to approach the work horizontally (Fig. 275).

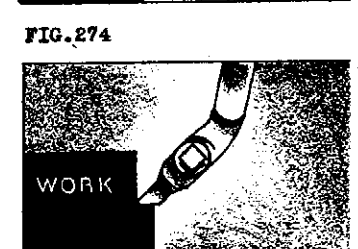
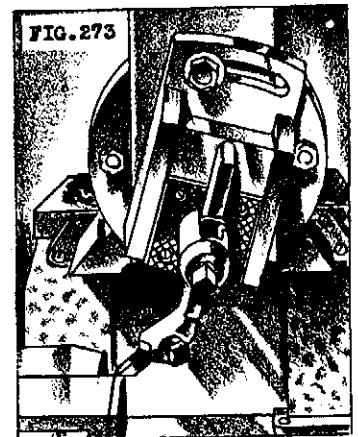
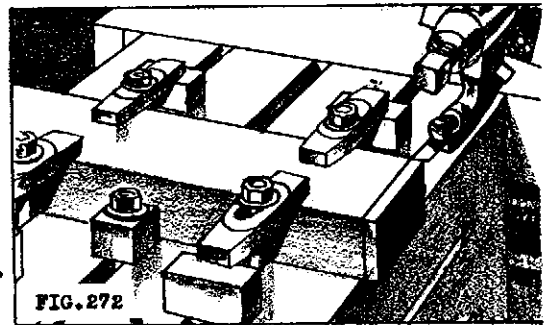
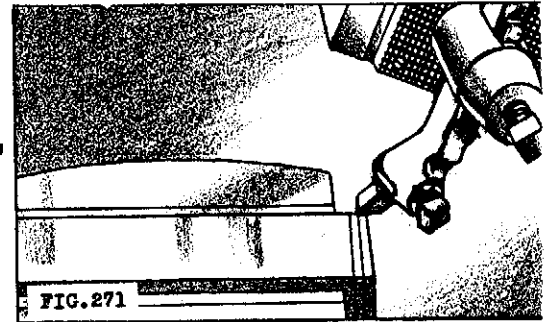

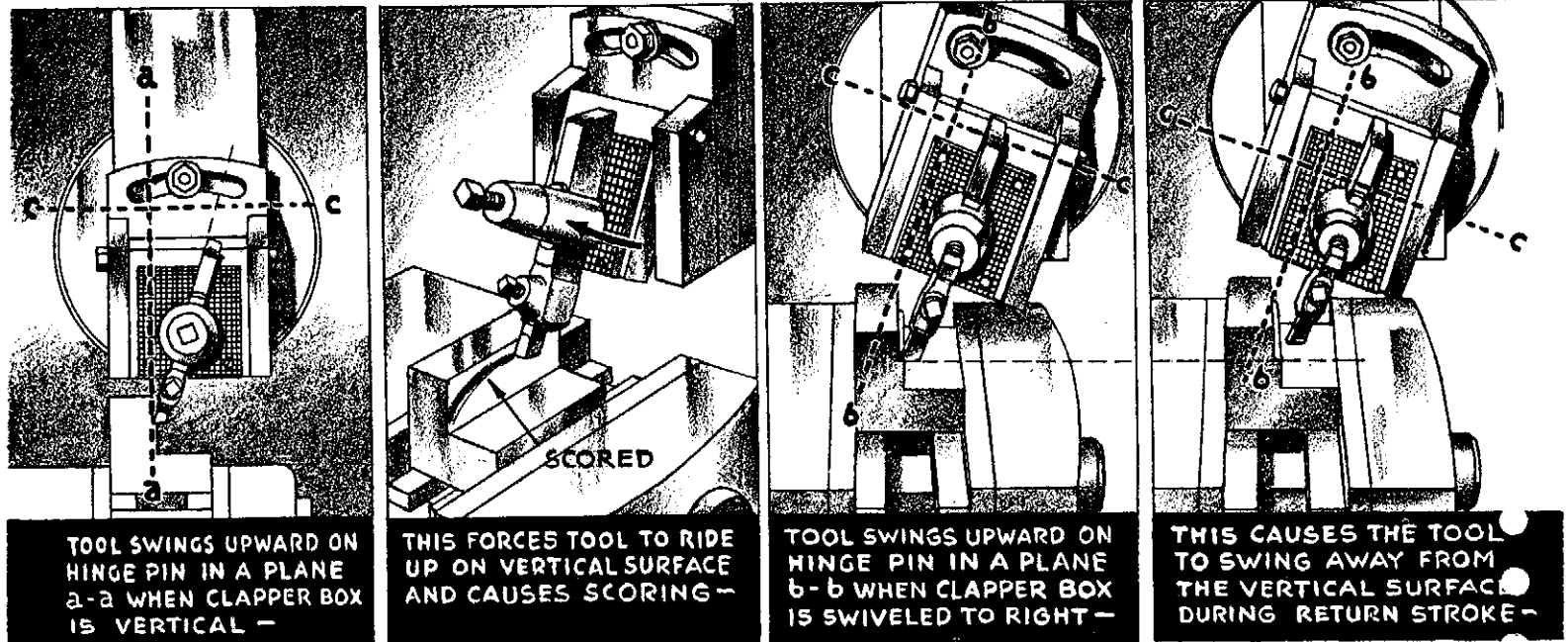

FIG. 276

FIG. 277

FIG. 278

FIG. 279

FUNCTIONING OF THE CLAPPER BOX

For all vertical and angular cuts, except slots and similar operations, the clapper box must be set at an angle from its vertical position, either to the right or to the left, depending upon the location of the shoulder or the end which is to be squared.

The adjustment is made to prevent the tool from dragging over the planed surface during the return stroke, at which time, as explained on page 16, the tool, together with the tool block, swings forward and lifts slightly on the hinge pin.

When the clapper box occupies a vertical position, as is usual when horizontal cuts are being taken, the tool point swings upward in a plane a—a (Fig. 276) during the return stroke of the ram, and, if the clapper box is not changed from this position for the vertical cut, the tool will drag over the finished surface, causing it to become scored (Fig. 277).

It is for the purpose of overcoming this objectionable condition of scoring that the clapper box is set in an angular position, for when the clapper box is in this position, the tool point swings in a plane b—b at right angles to the axis of the hinge pin c—c, on which the tool block swivels. Since the plane b—b is not parallel with the surface of the work, the tool point moves out from the finished surface (to the right) as soon as it swings upward and, as a result, does not score the planed surface. Obviously, the outward movement of the tool would be in the opposite direction if the clapper box were swiveled to the left (Figs. 278 and 279).

Correct location of the clapper box is assured if the upper end of the clapper box is moved in a direction away from the vertical or angular surface which is to be planed. In other words, the upper end of the clapper box must be swung to the right (Fig. 278) for squaring shoulders and ends on the right side and vice versa for vertical cuts on the opposite side. Moreover, the cutting tools must be ground accordingly for both roughing and finishing cuts.

COMBINED HORIZONTAL AND VERTICAL CUTS

A shoulder comprises a vertical surface which extends upward from a horizontal surface perpendicularly. Cuts in both a horizontal and a vertical direction are necessary, generally, to square a shoulder of any appreciable height, that is, for squaring a shoulder more than one-half inch high.

The only new element involved in machining a shoulder is that of forming the corner where the horizontal and the vertical surfaces meet. Aside from this, squaring a shoulder simply combines in one job, two operations which were described separately heretofore — horizontal and vertical shaping.

Work of this kind should be roughed out rather close to the layout lines, or close to the dimensions specified if a layout has not been made. The job should be placed in the machine to best advantage and a series of horizontal cuts should be made with a round-nosed tool having a small radius.

Since the horizontal cuts do not run entirely across the work, but, instead, end somewhere on its surface to form a shoulder which becomes increasingly higher as each succeeding cut is made, the clapper box should be adjusted as for vertical cuts as explained in the preceding section.

After the job has been roughed out, the horizontal surface should be finished to size first, and this should be followed by finishing the vertical surface with a suitable tool. (Refer to page 166.) When the vertical cut is being made, care must be exercised that the tool is not fed below the horizontal surface (Fig. 280).

If the corner is to be square, a tool shaped like the one in Fig. 316 should be used to remove the fillet left by the round-nosed tool. Micrometer control of the amount of metal removed is afforded in both directions — vertically by the micrometer

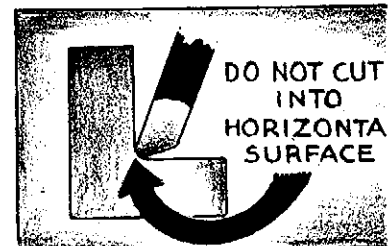
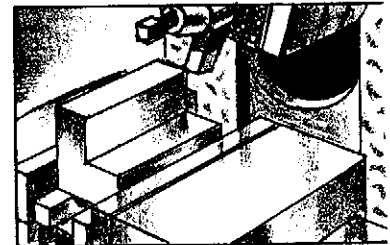
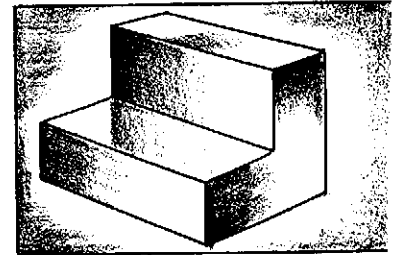
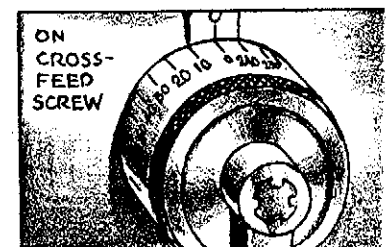
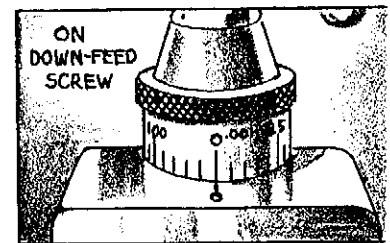
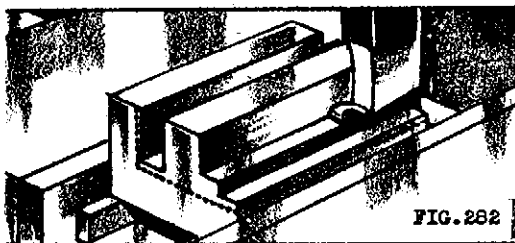
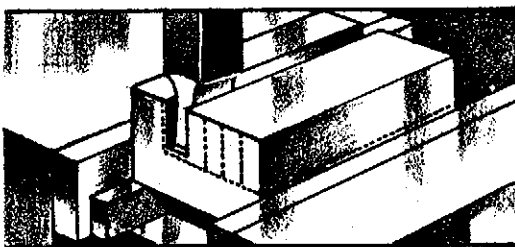
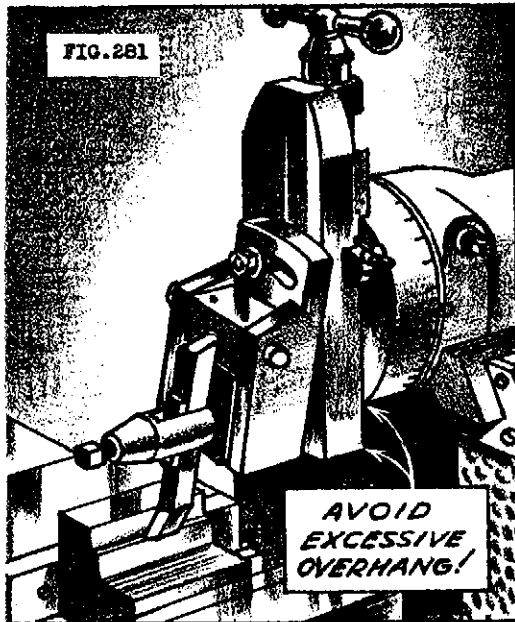

FIG. 280





collar on the down-feed screw; horizontally, by a similar collar on the cross-feed screw.

The length of the vertical cut which can be made on any shaper varies with the size of the machine. It is inadvisable, generally, to plan on using this entire distance for a vertical cut, for when the slide is fed down this distance, it will extend beyond the swivel block considerably. In its extended position, the slide is supported inadequately by the tool head, and, as a result, it is likely to break (Fig. 281).

It is good practice, therefore, when planning a vertical cut, to have the slide high enough at the start, and thus avoid this hazardous condition as far as possible. If for any reason the slide must be used in its extended position, the cuts must be light, and care must be used when feeding the tool, that it does not get caught in the metal.

For jobs on which the shoulder is not very high — not over one-half inch — a square-nosed tool such as has been shown on page 276, Fig. 457, can be used, not only for squaring the shoulder but also for planing the entire job. Its use saves changing tools, for this type of tool can be fed down to cut the shoulder and to remove most of the remaining metal. It can also be fed crosswise for taking a light cut to finish the horizontal surface (Fig. 282).

Moreover, whenever the height of the shoulder makes the use of a square-nosed tool practicable, the clapper box need not be swiveled, but instead it can remain in its usual position during both the vertical and the horizontal cuts.

S E L E C T E D R E F E R E N C E S

- | | |
|---------------------|-------------------------------------|
| Barritt, J. W. | Care and Operation of Machine Tools |
| Burghardt, Henry D. | Part II, Machine Tool Operation |
| Turner, William P. | Machine Tool Work |

HOW TO SHAPE HORIZONTALLY AND VERTICALLY

Unit 1-P53(A) Parts I, II, and III Pages 189 to 224

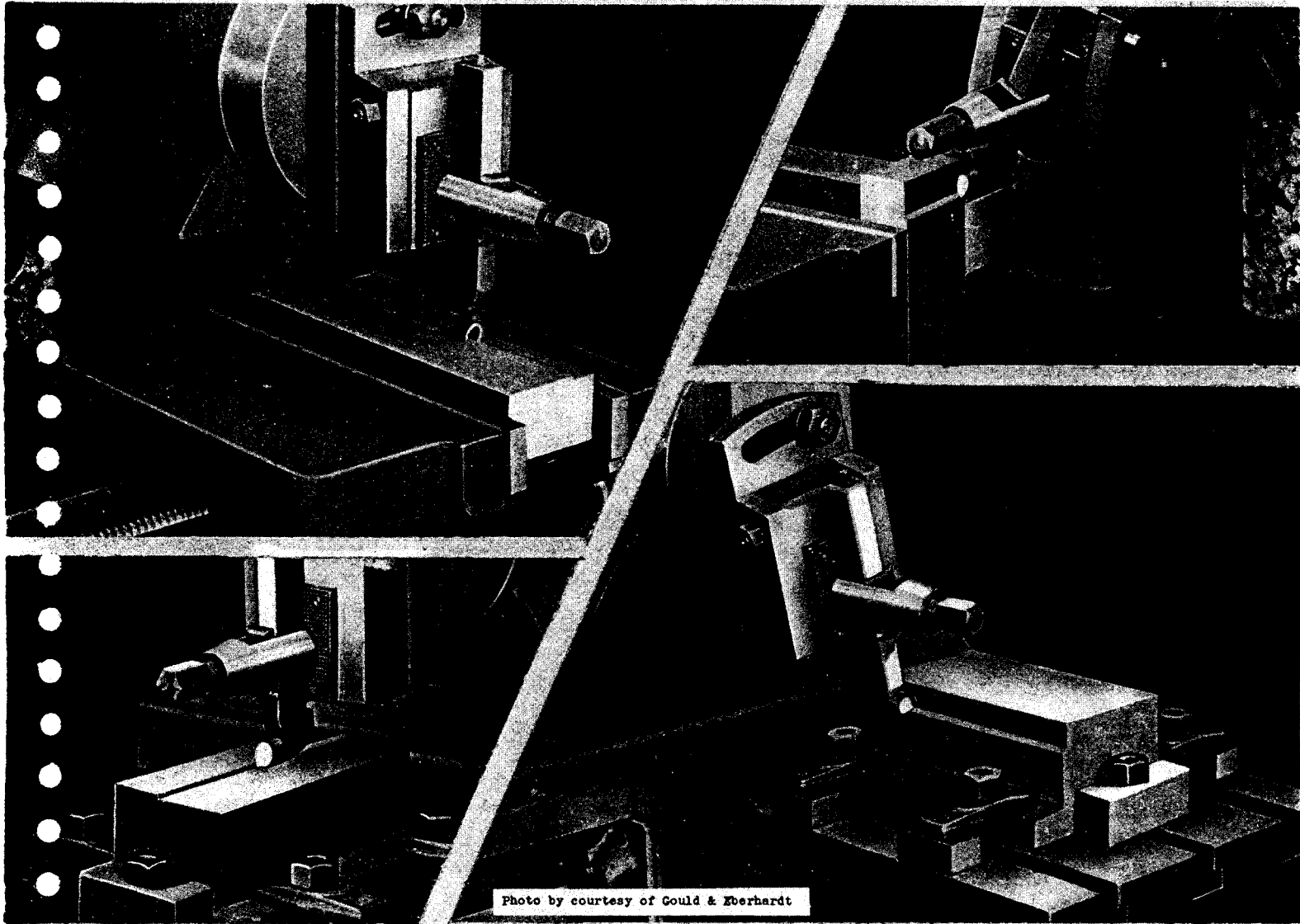

UNIVERSITY OF THE STATE OF NEW YORK
STATE EDUCATION DEPARTMENT
BUREAU OF INDUSTRIAL AND TECHNICAL EDUCATION

OBJECTIVES OF UNIT

1. To show how to set up the shaper and how to plane a horizontal surface on work held in the vise.
2. To explain the successive steps in planing the four sides of a square or rectangular piece.
3. To show how to set up the shaper for planing a vertical surface.
4. To show how to square a shoulder.

INTRODUCTORY INFORMATION

The shaper is intended primarily for planing flat surfaces on work usually held in the machine vise. Both horizontal and vertical cuts can be made with equal facility, since the shaper is constructed so that the work can be fed from side to side under the reciprocating tool to produce a horizontal surface, or so that the tool, instead, can be fed down on the work to produce a vertical surface.

Considerable work of a preparatory nature is required, however, before actual cutting is possible. This preliminary work consists of arranging the job, the machine, and the cutting tool, and is referred to as setting up the shaper.

More specifically, setting up includes proper placement of the work in the machine; it includes adjustment of the various parts of the machine, required to establish the proper relationship between the work and the tool, and it also includes other adjustments necessary for setting the length of stroke, the speed, and the feed to meet job specifications. Finally, it includes the selection and the subsequent placement in the machine of the cutting tool which best suits the type of cut to be made and the material in the job. The entire setup should be made with a view to having it as rigid as the construction of the shaper and the nature of the job make possible.

TOOLS AND EQUIPMENT

Crank or Hydraulic Shaper
Swivel Base Vise and Bolts
Lead Mallet
Micrometer
Outside Caliper
Tools and Holders

File
Brush
Chalk
Parallels
Cardboard
Oil Can

Tissue Paper
Wiping Cloth
Surface Gage
Steel Rod
Steel Rule
Try Square

• HOW TO SHAPE HORIZONTAL SURFACES

PROCEDURE

HOW TO MOUNT THE WORK IN THE SHAPER VISE

1. Mount the vise on the shaper, if it is not already in place, noting, first, the type of base on the vise, and then selecting from the several methods described on pages 119 to 121 the one which is appropriate for mounting a vise having this kind of base.

CAUTION

The weight of the vise makes it imperative that assistance be sought when placing it on the shaper.

2. Swivel the vise on its base, if necessary, placing the index line on the vise above the 90° graduation on its base so as to set the jaws parallel with the stroke. For approximate settings, follow the directions in How to Set the Shaper Vise with the Aid of the Graduations on the Base on page 124; for accurate settings, follow the directions given in How to Set the Vise Parallel with the Direction of the Stroke with an Indicator on page 132.
3. Open the vise jaws to receive the work, preferably in a position with one of the larger surfaces up when the work is not square in shape.
4. Brush chips and other foreign material from the vise jaws and from the bottom of the vise opening; wipe these surfaces with a clean cloth; and, finally, remove any burrs which will interfere with the subsequent seating of the work.

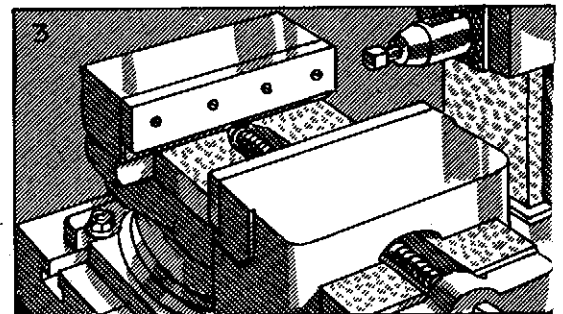

NOTE: One of the important factors contributing to accurate machine work is cleanliness. To a machinist, cleanliness means not only freedom from chips and dirt, but freedom from burrs as well. Whenever a job is to be set in the machine, the work, the holding device, and the parallels too, if they are used, should be absolutely clean.

5. Measure the depth of the vise jaws and the thickness of the job to ascertain whether or not the layout line indicating the depth of cut will extend above the vise about 1/8" when the job rests on the bottom of the vise opening.
6. Place two identical parallels of correct height under the job, if the work

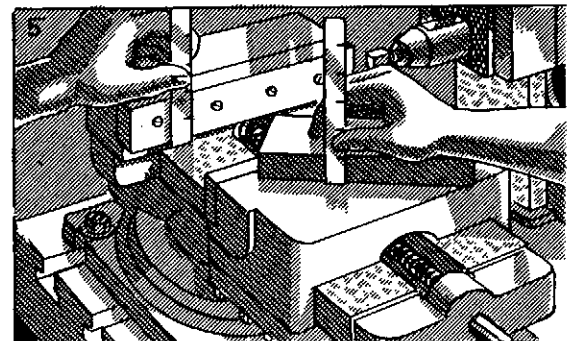

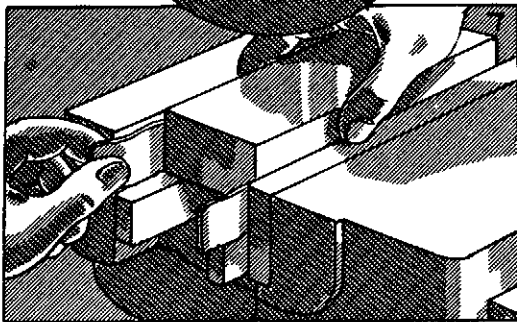
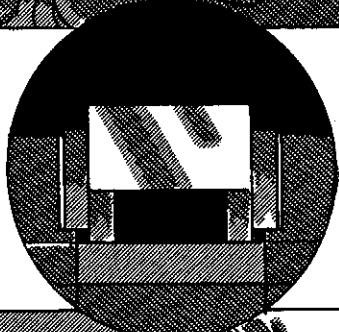
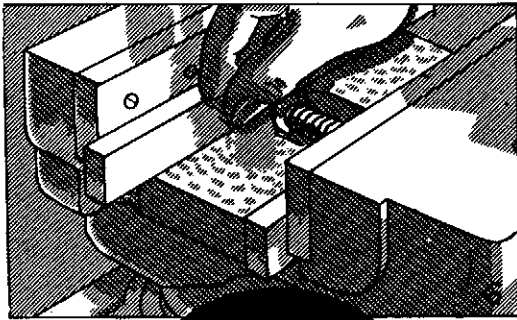

is too low in the vise, spacing the parallels as widely as possible. (Refer to page 104.)

NOTE: Two narrow parallels are usually preferred to a single one of greater width, especially for supporting castings. Inasmuch as a casting seldom has a straight surface, the use of narrow parallels makes it easier to determine whether or not the work has been properly seated, for the narrow parallels contact the work near its outer edges only and thus avoid contact with any high spots likely to be present in the center of the casting.

7. Place cardboard alongside the vise jaws if a casting is to be clamped. It will absorb irregularities on the surface of the casting, and, in doing so, will protect the faces of the jaws. At the same time the cardboard will tend to distribute the pressure of the jaws evenly over the work.

8. Place the work on the parallels, approximately in the center of the vise; then tighten the vise, exerting enough pressure on the vise crank to hold the work securely during the subsequent cuts.

NOTE: When the vise is tightened, the work lifts slightly and, consequently, does not rest on the parallels intended to support it during the cut. The lifting of the work occurs concurrently with that of the movable vise jaw, for when the vise is tightened, the jaw advances until it grips the work; then, as additional pressure is applied on the crank, the jaw, no longer able to advance in its original direction, lifts slightly and carries the work up with it. Lost play between the vise jaw and the body of the vise is responsible for this action. It cannot be eliminated entirely where parts must be free to move on one another.

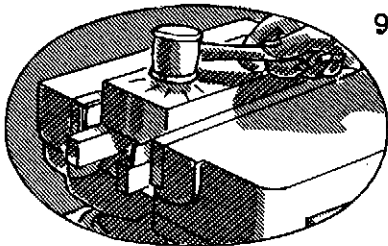

9. Tap lightly on the work to seat it on the parallels, using a lead mallet or block for such materials as steel and cast iron, and a plastic or leather hammer for softer materials such as aluminum, so that their surfaces will not become dented.

NOTE: A light blow usually is sufficient to seat the work, for if too hard a blow is struck, the work tends to rebound from the parallels. The intensity of the blow required, however, can best be determined by slightly moving a parallel under the work while at the same time delivering

light blows with the mallet on the work. Then, if the parallels are still loose, the intensity of the blow can be increased to the point where the work will be forced down and the parallels can no longer be moved (Fig. 283).

10. Tug on the parallels to see whether or not they are tight under the job, if for any reason the vise requires additional tightening after the work once has been seated on the parallels. The work invariably lifts after each tightening of the vise and, therefore, requires repetition of the seating procedure to place it down on the parallels again.



Oil the shaper as directed in How to Oil the Shaper, beginning on page 47.

HOW TO ADJUST THE CUTTING TOOL AND THE TOOL HEAD

1. Read the description of the horizontal cut beginning on page 176.
2. Set the tool head at right angles to the machine table; that is, place opposite the index line on the ram whichever of the graduations on the swivel block, either zero or 90°, that will cause the head to be square with the table. Refer to How to Adjust the Tool Head on page 91.
3. Set the clapper box in a vertical position for light or medium cuts, but for heavy cuts swivel the upper end of the clapper box in a direction similar to that in which the work is to feed. Refer to the Position of the Clapper Box on page 179.
4. Run the tool slide up on the head so that it will not extend below the swivel block when the tool is set to the work later. (Refer to page 178.)
5. Measure the opening in the tool post so that either a forged tool or a tool holder of the correct size may be selected.
6. Select a straight left-cut forged tool suitably ground for taking a horizontal roughing cut on the kind of material in the job; or, if a straight tool holder is to be used instead, insert a tool bit ground to a similar

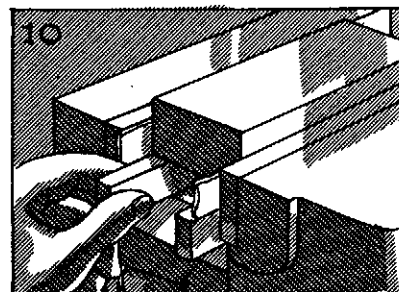
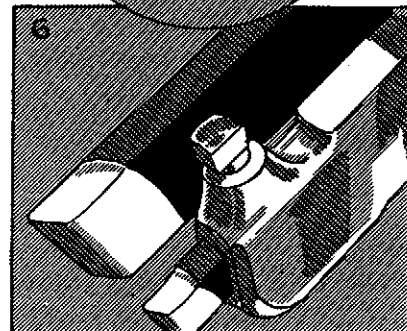
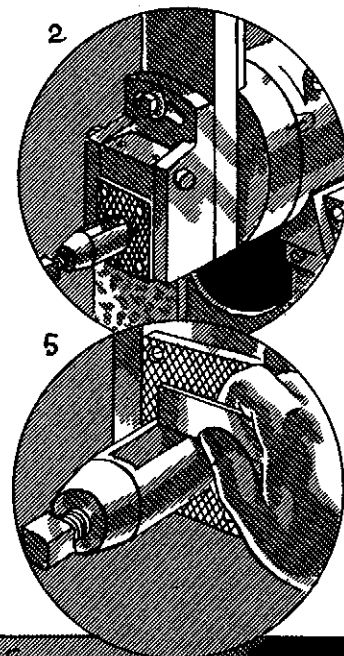

FIG. 283



shape. (Refer to pages 166 and 171.)

CAUTION

Grip the tool bit in the holder as short as practicable for the cut being made.

7. Securely clamp the tool or the tool holder, whichever has been selected, in the tool post in a vertical position, ordinarily allowing it to extend no more than 1-1/2 inches beyond the tool block; but, if the cut is to be heavy, clamp the tool in a position pointing slightly in a direction away from the work. (Refer to page 180, Fig. 261.)

HOW TO ADJUST THE SHAPER PRIOR TO TAKING THE CUT

1. Adjust the cross rail on the column so that the surface to be planed is approximately two inches below the ram. Refer to How to Adjust the Cross Rail on page 77.

CAUTION

Make certain that the bolts which clamp the cross rail to the column, as well as those which clamp the table support, have been loosened before attempting to raise or lower the cross rail. It is equally important that these bolts be tightened again, and in the order given on page 77, after the rail has been relocated.

2. Measure the length of the surface which is to be planed; add approximately one inch to this dimension in order to provide for clearance of the work by the cutting tool at both ends of the stroke. (Refer to page 79.)
3. Adjust the ram stroke for a length equivalent to that derived in step No. 2. For adjusting the crank shaper, refer to How to Adjust the Stroke on pages 79 and 80; for the hydraulic shaper, refer to How to Adjust the Stroke and the Position of the Ram on page 92.

4. Adjust the position of the stroke so that the tool covers the entire surface which is to be planed. When using a crank shaper, refer to How to Adjust the Position of the Ram on page 81; when using a hydraulic shaper, use the reference given in step No. 3.

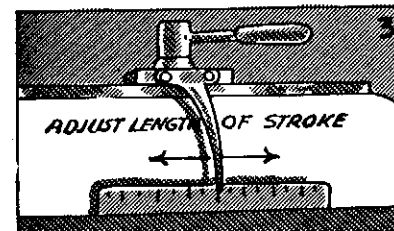
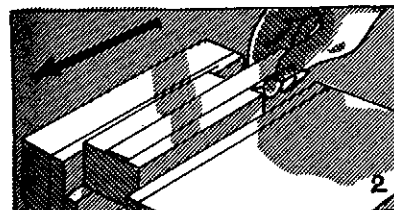
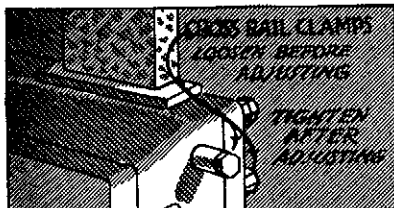
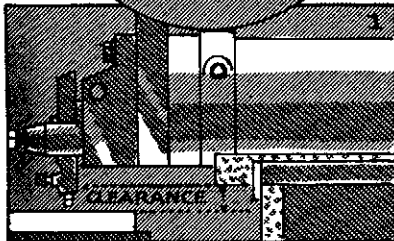
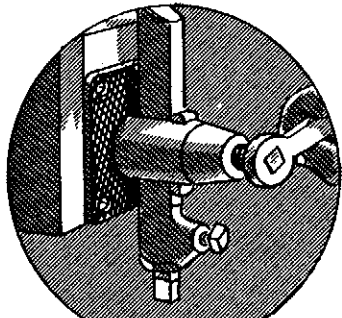

5. Consult the table, Allowable Cutting Speeds — Feet Per Minute on page 308. From this table, determine the cutting speed in feet per minute which is to be used. Base the decision on the kind of material to be planed, and on the type of cut, whether roughing or finishing, which is to be made with a High-Speed Steel cutting tool.

NOTE: Most cone-driven shapers are unprovided with charts such as appear on the direct-driven shapers. For this reason, step No. 5 may be omitted when a cone-driven shaper is used, inasmuch as the cutting speed in feet per minute cannot be determined when the number of ram strokes per minute is unknown. (Refer instead to pages 83 and 84.)

6. Determine the number of strokes per minute which will result in a cutting speed in feet per minute approximately the same as that decided upon in step No. 5.
7. Read page 82; then select from the procedures given for setting the speed on various types of shapers, the one which is appropriate for the shaper being used, and adjust the shaper for the number of strokes per minute decided upon in step No. 6. For setting the speed on a crank shaper, refer to How to Adjust the Speed of the Ram on page 82; for setting the speed on a hydraulic shaper, refer to How to Adjust the Speed of the Ram on a Hydraulic Shaper on page 94.

CAUTION

Do not attempt to shift gears while the shaper is in operation.

8. Adjust a rate of feed commensurate with the depth of cut to be made and the surface finish desired. For the crank shaper, refer to How to Adjust the Automatic Feed on pages 90 and 91; for the hydraulic shaper, refer to How to Adjust the Cross Feed on a Hydraulic Shaper on page 95.

NOTE: The depth of the cut and the resistance of the material being cut vary to such an extent in different jobs that it is impossible to recommend a rate of feed which will function equally well under all conditions. It is best, therefore, to begin the cut with a light feed, for example, .010" per stroke, and increase the rate when it becomes apparent this can be done to advantage. (Refer to page 304.)

HOW TO TAKE THE ROUGHING CUT

1. Consult the blueprint or the job layout and ascertain therefrom the finished size of the job in order to determine how much material is to be removed in the shaper.

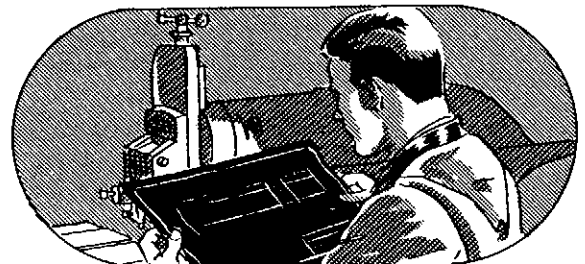

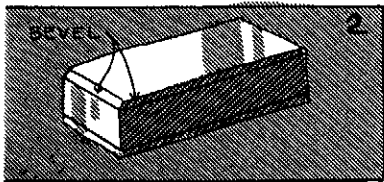

- Plan to remove approximately half the excess material from the top surface and the other half from the opposite side when both these surfaces are to be planed. Refer to The Roughing Cut on page 181.

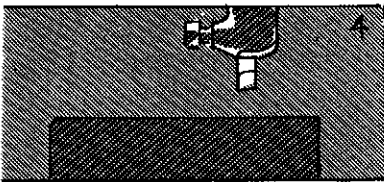

- Bevel the edges of the casting at the ends of the cut to prevent breakage of the corner below the finished surface. (Refer to page 182.)

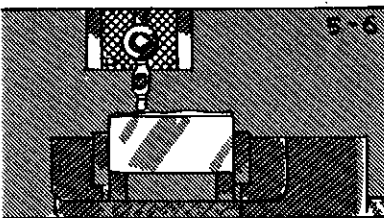

- Make certain that the tool is higher than the surface of the work and that the ram too will clear any projections which may extend from irregularly shaped work. (Refer to page 178.)

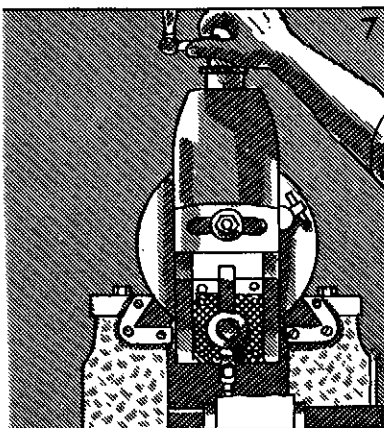

- By means of the cross-feed screw, move the work together with the table, bringing it in line with the cutting tool.

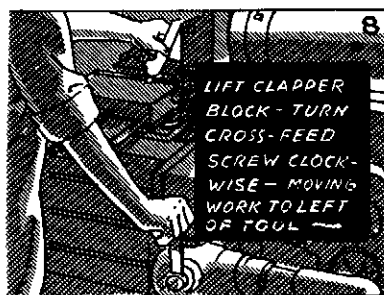

- Place the ram so that the tool comes to some point over the surface to be planed, preferably over the low point on the surface. (Refer to page 206.)
- Move the tool down (with the ram stationary) by turning the down-feed screw in a clockwise direction until the tool just barely touches the work; then adjust the micrometer collar, placing the zero opposite the index mark. (Refer to page 91.)
- To prevent interference with the work, lift the tool together with the tool block on the hinge pin; then move the work to the left of the tool, inasmuch as a left-cut tool has already been placed in the tool post.
- With the aid of the graduations on the micrometer dial, set the tool to the desired depth for the first roughing cut; then lock the tool slide in place. Remove at least $1/16$ " of metal in order to get under the scale on the casting, provided this amount of metal can be removed without cutting the work undersize.

✓ HAVE ENTIRE SET-UP CHECKED BY YOUR INSTRUCTOR ✓

- Start the shaper (Refer to pages 57 and 58.); then feed the work to the tool by hand until the cut is just started and its depth is apparent.

CAUTION Keep the face and the eyes a safe distance from the work, or better still, wear goggles as a protection from flying chips.

11. Stop the shaper and check the correctness of the tool setting. If further adjustment in the depth of the cut is necessary, make it only after the work has been moved from under the tool.
12. Start the shaper again; then engage the automatic feed and complete the cut.
13. Disengage the feed. Bring the table back to the position for starting the cut — with the work to the left of the tool — and take additional roughing cuts if needed, allowing between .010" and .015" for the finishing cut.

HOW TO TAKE THE FINISHING CUT

1. Stop the shaper and replace the roughing tool with a finishing tool suitably ground for cutting the kind of material in the job. Refer to page 166 for the selection of the tool and to page 182 for a description of the finishing cut.
2. Bevel the edges of castings with a file to prevent the keen cutting edge of the finishing tool from coming in contact with sand and scale.
3. Place the work and the ram so that the tool is again over the machined surface in order that the cutting edge of the finishing tool may be set parallel with the surface of the work.
4. With the tool clamped lightly in the tool post and its lower end close to the work, tap the tool until the cutting edge is exactly parallel with the surface to be finished; then tighten the tool-post screw securely.
5. As an aid in setting the finishing tool to the work preparatory to adjusting it for a cut of the desired thickness, place a piece of paper or the blade of a thickness gage on the work and carefully lower the tool until it barely touches the feeler.
6. Set the graduated collar on the down-feed screw at zero; move the work to the left of the tool,

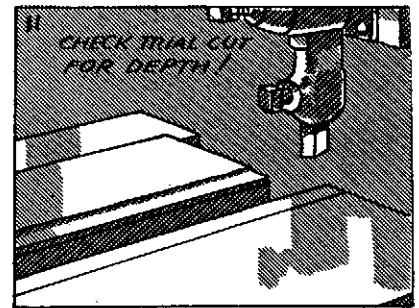

CAUTION

KEEP FINGERS AWAY FROM CUTTING TOOL, WORK AND VISE WHEN SHAPER IS IN OPERATION

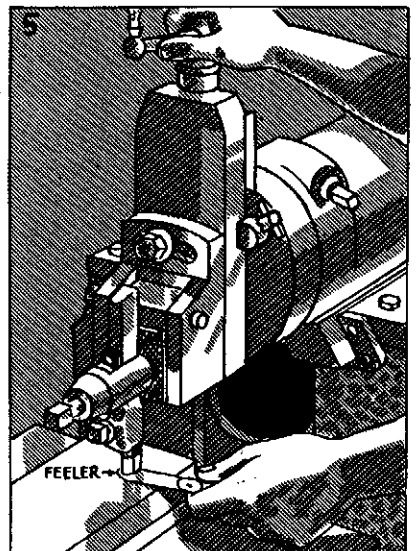
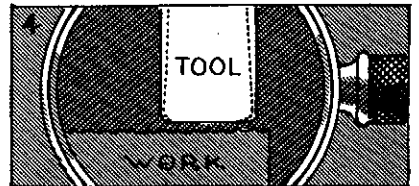
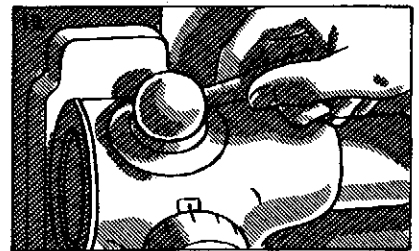

and then lower the tool the number of thousandths necessary to take a cut of the desired thickness, taking into consideration also the thickness of the feeler used for setting the tool to the work.

CAUTION

When extreme accuracy and a good finish are required, plan to remove the metal allowed for finishing in two cuts or more instead of one, the first cut serving as a trial cut only.

7. Reduce the speed somewhat whenever a finishing tool having a wide cutting edge is used. For round-nosed tools, however, use the speeds recommended in the table — Allowable Cutting Speeds — Feet Per Minute on page 308.
8. Start the shaper and note whether or not the stroke still covers the entire length of the work. Repeat step No. 4 on page 194 if the position of the stroke is incorrect. A change in position is quite likely to occur when the roughing tool has been replaced with a spring-type finishing tool (Fig. 269).
9. Increase the rate of feed so that the tool will move over approximately one-half the width of the flat cutting edge for cast iron; but for steel, use a fairly fine feed per stroke.
10. Engage the automatic feed and take the finishing cut with the tool slide locked in place. (Refer to page 15.)

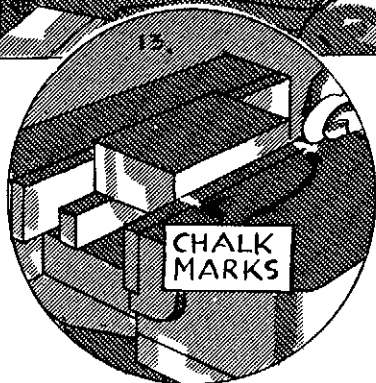
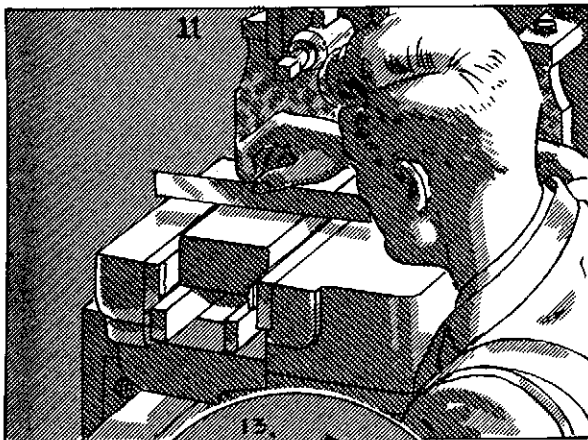

11. Stop the shaper with the ram in its rear position, brush the chips from the work, test the planed surface with a straight edge, and, finally, take measurements to ascertain whether or not the work has been accurately machined.
12. Bring the table back to the position for starting the cut and make further adjustments of the tool with the aid of the micrometer dial, if the work is still oversize.
13. When planing short work, place a chalk mark on the vise at each end of the work to assure its being placed in the vise in the same position for subsequent cuts and thus avoid changing the position of the ram stroke each time the job is removed from the vise.
14. Remove the job from the vise, and file from its edges the burrs produced by the tool,

being careful not to mar the finished surface.

15. Brush all chips from the machine when the job is finished, and return the parallels and other accessories to their proper places in a clean condition.

NOTE: If other surfaces are to be machined, defer step No. 15 until all work has been completed.

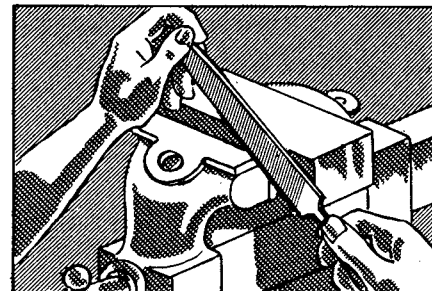

HOW TO PLANE THE REMAINING SIDES OF A SQUARE OR RECTANGULAR JOB

NOTE: When several surfaces on a job are to be planed, instead of only one, it is considered good practice to rough out all these surfaces before finishing any one of them, in order to relieve internal strains which are likely to be present, especially in castings. For this job, however, the finishing cut will be made immediately after the roughing cut on each side has been completed.

HOW TO CLAMP THE WORK AND TAKE THE CUT ON THE SECOND SIDE

1. Clean out the vise and make certain that the finished surface on the work is absolutely clean also.
2. Set the work in the vise with the side just finished against the fixed jaw, and on parallels, if they are needed, so that the surface to be planed will be slightly above the vise jaws. Refer to step No. 5 on page 191.
3. Place a round piece of steel horizontally between the movable vise jaw and the work as shown in Fig. 284; then draw the vise up tightly.

NOTE: This steel rod, which should be placed about halfway up on the vise jaw, makes only a line contact with the work and the vise and thus causes the finished surface of the work to be brought squarely against the fixed jaw of the vise, which is assumed to be square with the table.

When the rod is not used and the vise is tightened on the unmachined surface of the work instead (Fig. 285), the finished side of the work is quite likely to

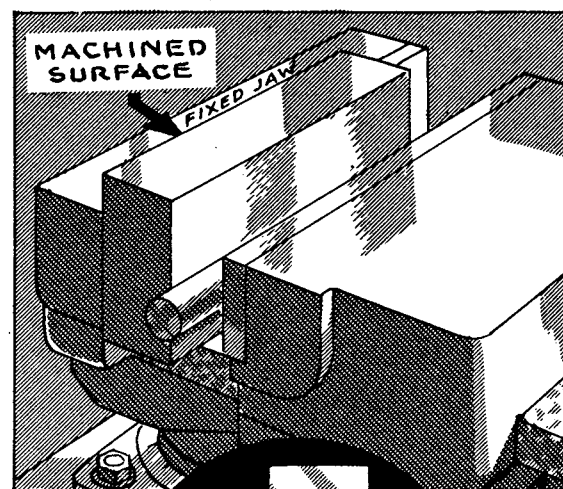

FIG. 284

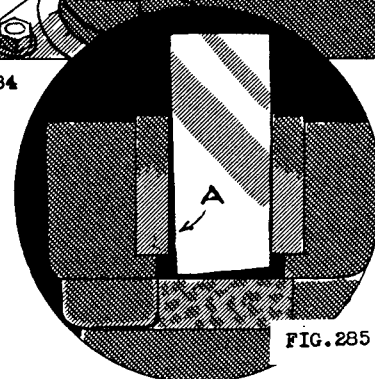
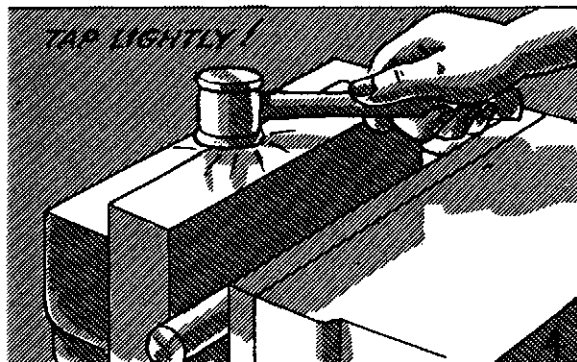
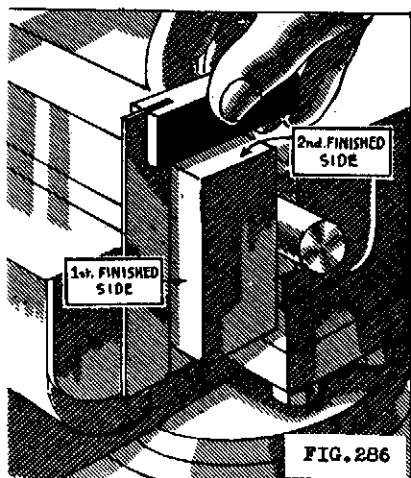

FIG. 285



change its relationship with the fixed jaw as shown at A. As a result of this condition, the side and the top surfaces will not be cut square with each other.

4. Tap the work lightly with a lead mallet to seat it on the bottom of the vise opening or on the parallels, whichever means is used for supporting the work. Refer to the note following step No. 8 on page 192.
5. Remove the finishing tool and replace it with the roughing tool used for shaping the first surface. Refer to steps Nos. 6 and 7 on pages 193 and 194.
6. Make certain that the position of the ram stroke is such that the tool will cover the entire surface of the work, for unless the work has been placed in the vise in the same lengthwise position as before, an adjustment will be necessary. Refer to step No. 13 on page 198.
7. Reduce the rate of feed to that used for the first roughing cut. Refer to step No. 8 on page 195.
8. Proceed to take the roughing cut as directed in How to Take the Roughing Cut beginning on page 195.
9. Take the finishing cut as directed in How to Take the Finishing Cut beginning on page 197.
10. Use a fine file to remove from the corners of the work the burrs produced by the cutting tool; then wipe the two machined surfaces clean.



11. Determine whether or not the finished surfaces are at right angles to each other by placing the beam of a try square against the surface just finished and the blade of the square across the other finished surface (Fig. 286).

NOTE: If all light is excluded from under the square when its beam is held firmly against the surface just finished and its blade has been brought carefully to the other finished surface, then these two sides of the work are at right angles to each other. The remaining sides of the work can then be machined also with the assurance that they too will be square with each other, provided the necessary precautions are observed when the work is clamped in the vise.

However, if light is visible under the blade, the work is not square, and this condition should be corrected at this time by using one of the methods suggested on page 203.

12. Remove the work from the vise and prepare to plane the third side of the work.

HOW TO CLAMP THE WORK AND TAKE A CUT ON THE THIRD SIDE

1. Make certain that the vise opening and both finished surfaces on the work are absolutely clean and free from burrs.
2. Place the work in the vise with the surface that has just been finished resting on the bottom of the vise opening — or on parallels if needed — and the first side planed resting against the fixed jaw as before (Fig. 287).
3. Place the rod between the movable jaw and the work as for the previous cut; tighten the vise, and, finally, seat the work in the manner used heretofore.

NOTE: In order that it may be known with a certainty that work which does not require the use of parallels has been properly seated in the vise, a piece of tissue paper should be placed under each end of the work and allowed to extend so that it can be grasped with the fingers. Obviously, the work has been properly seated when the paper is tight and cannot be withdrawn from under the work.

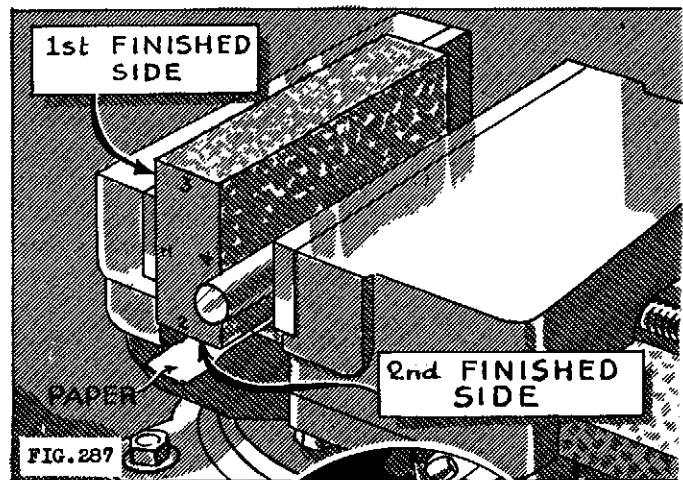

4. Take the roughing cut as directed in steps Nos. 3 to 12 on pages 196 and 197.
5. Remove the burrs from the corners of the work, clean the machined surface, and then check the work with a square (Fig. 286).
6. Take a measurement with a micrometer at both ends of the work to determine whether or not the side just finished is parallel with the side opposite (the underside) and to see also how many thousandths must be removed to cut the work to size with the finishing tool (Fig. 288).
7. Take the finishing cut as directed in How to Take the Finishing Cut on page 197.

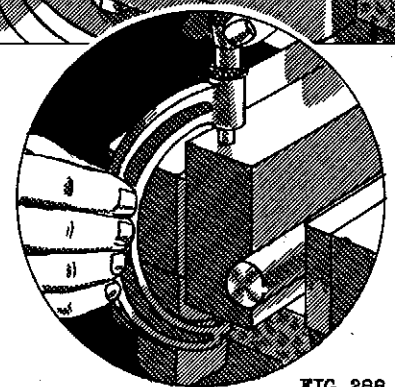

HOW TO CLAMP THE WORK AND TAKE THE CUT ON THE FOURTH SIDE

1. Make certain that the vise opening is absolutely clean and that the three sides of the work which already have been machined are clean also, and without burrs.

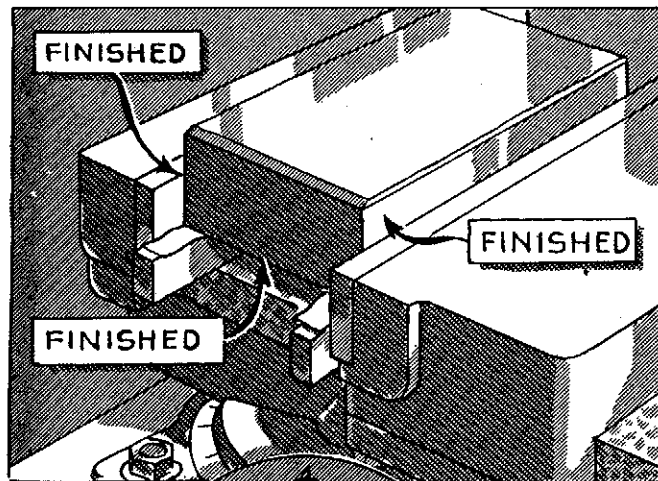

2. Place the work in the vise with the first side machined down on strips of tissue paper placed in the vise under both ends of the work, or, if the work is supported on parallels, place a strip of tissue paper under each corner of the work (Fig. 289).
3. Tighten the vise, leaving out the rod which was used before; then tap the work with a lead mallet according to instructions given previously.
4. Pull lightly on the paper strips to ascertain whether or not the work has been seated properly.

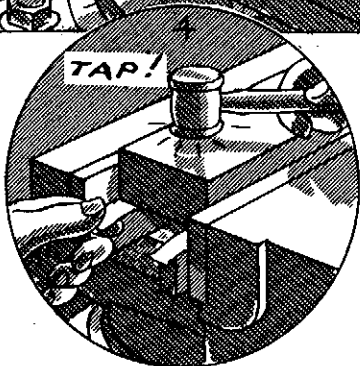

FIG. 289

5. Take the roughing cut as directed in steps Nos. 3 to 12 on pages 196 and 197.
6. Take the finishing cut as directed in How to Take the Finishing Cut on page 197.
7. Give the machine a thorough cleaning, and return all parallels and other accessories to their proper places in a clean condition.

HOW TO SQUARE THE ENDS

The ends of short pieces may be planed square with their sides by following the directions below for clamping the work and then taking a horizontal cut.

The ends of longer pieces are planed to best advantage, however, by means of a vertical cut. The procedure for this kind of cut has been explained in How to Plane Vertically, beginning on page 210.

1. Swivel the vise on its base so that the jaws are at right angles to the stroke. Refer to pages 124 and 133 respectively for the approximate and the accurate methods of setting the vise.
2. Make sure that the work and the vise are clean and free from burrs.
3. Place the work in the approximate center of the vise with one

end on the bottom or on parallels (Fig. 290).

4. Hold a try square down firmly against the bottom of the vise; then set the side of the work parallel with the blade of the square and tighten the vise lightly.
5. Check the setting of the work with the square, tapping the work on one side or the other, if necessary, to make further adjustments.
6. Tighten the work securely in the vise when it is square.
7. Follow the directions for taking a horizontal cut, beginning on page 193.
8. Use a square to check whether or not the end has been planed square with the sides.
9. To square the opposite end, place the work in the vise with the finished end down, tap the work to seat it properly, and then cut the piece to length as directed in step No. 7.

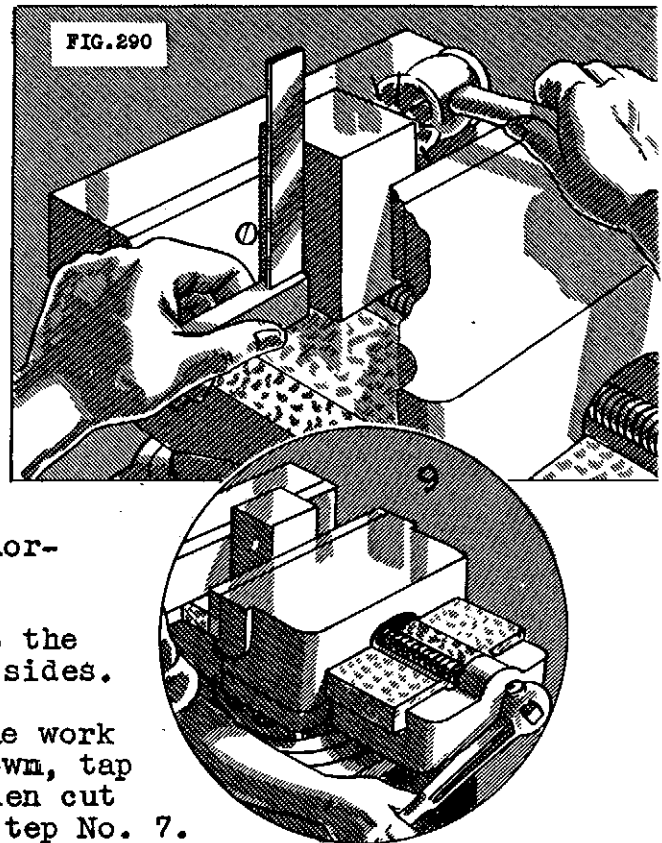

HOW TO CORRECT INACCURACIES BETWEEN ADJACENT SURFACES INTENDED TO BE AT RIGHT ANGLES

Even though the foregoing directions for clamping the work and planing its sides have been followed conscientiously, subsequent testing with a try square may reveal that these sides do not form perfect right angles.

This inaccuracy, evident by light visible under the blade of the square, may be the result of carelessness at the time the work was placed in the vise. On the other hand, it may reflect inaccuracies caused by wear on the vise jaw or wear in the machine. But, regardless of the cause of the inaccuracy, steps a, b, and c, which follow, should be taken first when attempting to correct this undesirable condition so as to eliminate errors resulting from carelessness before attempting to eliminate errors resulting from one of the other causes.

The logical time to make this correction is immediately after a true cut has been taken from the second side of the work and a test with a try square makes it obvious that the surface just planed is not square with the first surface which now rests against the fixed jaw of the vise (Fig. 292).

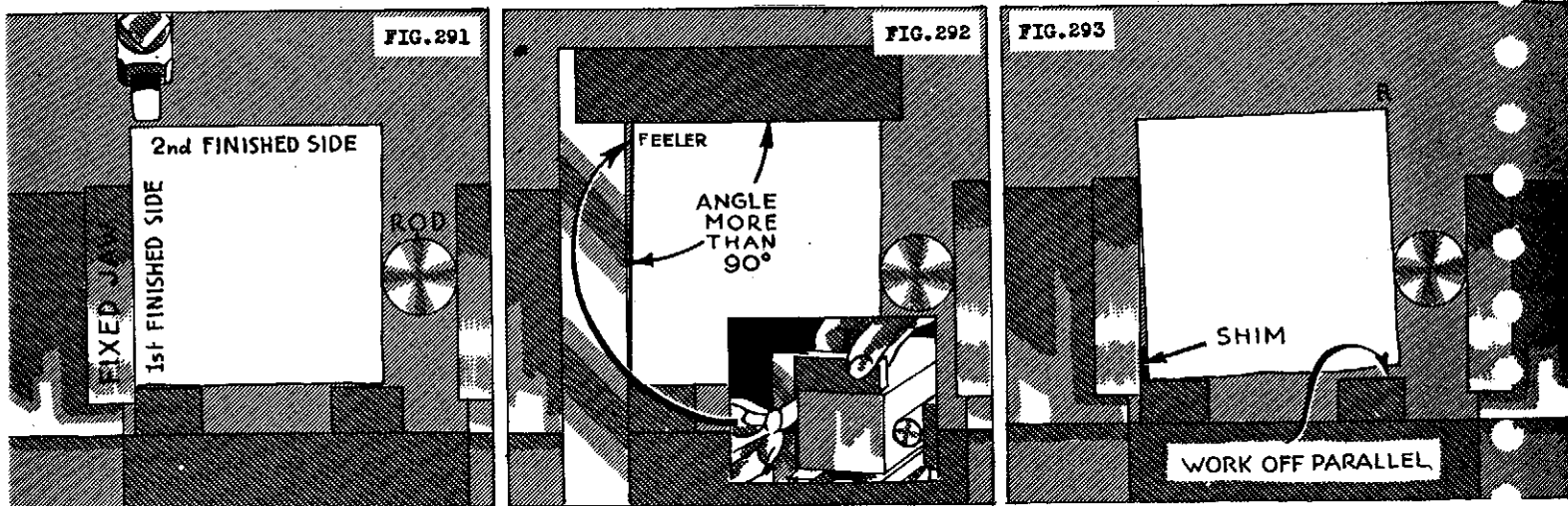

- a. Thoroughly inspect the work, the vise, and the parallels too, if they are used, and remove foreign material and burrs which may have been overlooked before and may have prevented the proper seating of the work in the vise.
- b. Place the work in the vise again, observing carefully all the precautions regarding cleanliness and proper clamping and seating. Then take a light cut.
- c. Remove the burrs produced by the tool, clean the surfaces of the work, and, finally, check their squareness with a try square, placing its beam on the surface just finished and the blade across the adjacent side (Fig. 292).

NOTE: If the adjacent side is still not square with the upper surface, proceed to correct this condition in the manner explained in How to Test the Fixed Jaw for Squareness with the Aid of an Indicator on page 129, or correct it by using paper shims between the work and the vise jaw instead, as directed below.

1. After the work has been placed in the vise as directed in steps Nos. 2 to 4, page 199, following the planing of the first side, and a true cut has been taken from the second side (Fig. 291), test the work with a try square (Fig. 292).
2. Measure the opening between the blade of the square and the side of the work with a paper feeler or with the blade of a thickness gage in order to determine the approximate thickness of the shim required to correct the inaccurate condition in the work.
3. If the angle formed by the two sides is greater than 90° and the opening occurs at the top as in Fig. 292, place along the bottom of the work a paper shim similar in thickness to

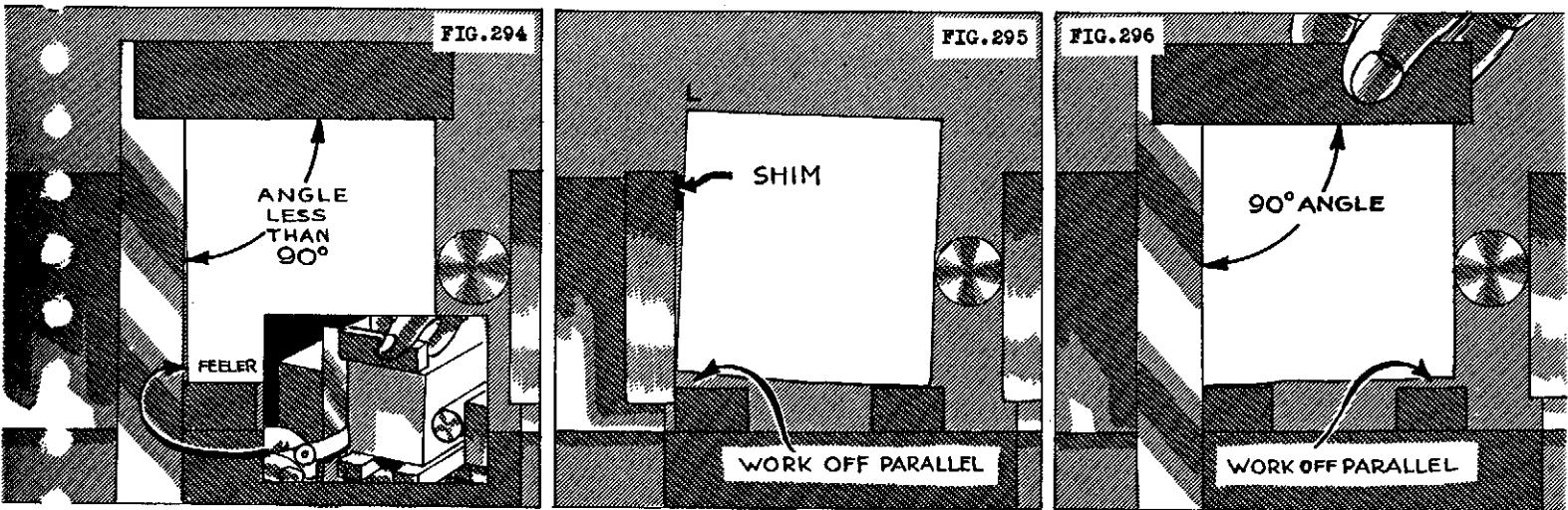

that of the feeler used for measuring the opening between the square and the work. The shim will cause the work to tilt slightly in the vise, raising its right-hand edge, and, as a result, the subsequent cut will remove slightly more material at R (Fig. 293) than at the other side of this surface.

4. On the other hand, if the angle formed is less than 90° and the opening between the square and the work occurs at the bottom (Fig. 294), place the paper shim along the top (Fig. 295). Placing the shim in this place will also tilt the work slightly, but in a direction opposite to that in Fig. 293, with the result that the tool will now remove slightly more material at L (Fig. 295) than at the other end of this surface.
5. If the adjacent sides are not at right angles after inserting the shim and removing a trial cut, replace the shim with one which is proportionately thicker, providing the opening still occurs in the same place as before taking the trial cut, for this indicates that the work has not been tilted sufficiently. A thinner shim, of course, should be used when the opening along the square occurs at the end opposite that at which it occurred before the shim was inserted and a trial cut taken.

NOTE: When a shim has been placed alongside the work in the vise, it will be impossible to seat the work so that both parallels are tight under the job, for with the insertion of the shim, even though it is very thin, the work becomes tilted somewhat, with the result that the bottom of the work is now no longer parallel with the bottom of the vise opening (Fig. 295). Work on which the bottom side is not at right angles with the side placed against the fixed jaw of the vise (Fig. 296) also is incapable of being seated on both parallels. In this instance, however, it is the condition of the work, and not a condition created by the insertion of a shim, which causes one edge of the bottom surface to be higher than the other edge.

HOW TO USE THE SURFACE GAGE ON SHAPER WORK

Even a flat casting is seldom of uniform thickness from end to end or from corner to corner, and, besides, it is frequently warped out of shape. Therefore, when a casting has been placed on parallels or on the bottom of the vise, its underside may be approximately level, but some point on its upper surface may be lower than others.

One use for the surface gage is to find this low point on the casting so that the cut may be set from this point. The assumption is that if the cut is deep enough to remove the scale from this place, the rest of the surface also will be "cleaned up."

Another setup for which the surface gage is frequently used on the shaper is one that requires the upper surface on a casting, instead of the lower one, to be level so that this surface can be planed by taking the smallest cut possible.

In addition, the surface gage is used for scribing lines parallel with the machine table to show the location of finished surfaces, and for setting up work according to a layout on the job.

HOW TO FIND THE LOW CORNER ON A CASTING HELD IN THE MACHINE VISE

1. Wipe the upper surface of the movable jaw, or the top of the table, whichever is to be used, with a clean cloth; then rub the palm of the hand over that portion of the surface on which the surface gage is to be used.
2. Rub chalk on the corners of the work so that the slightest touch of the scriber will become apparent immediately.
3. Wipe the base of the surface gage clean, then draw it across the palm of the hand to remove any small particles of dirt which may not have been removed with the cloth.

4.

Place the gage on the surface which has been prepared; then adjust the spindle and the scriber (Fig. 297) so that the four corners of the work can be reached with the bent end of the scriber.

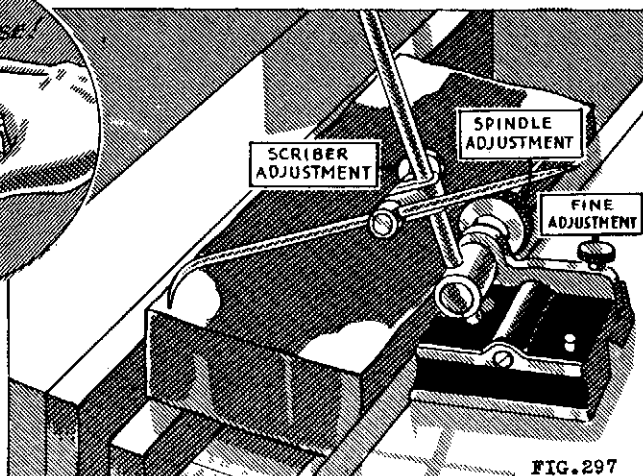
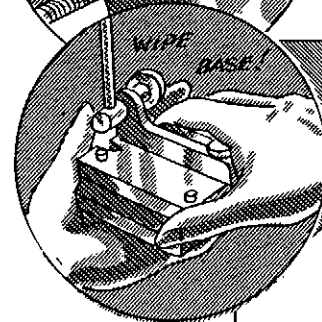
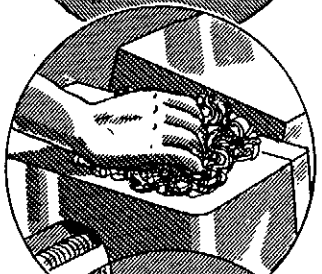
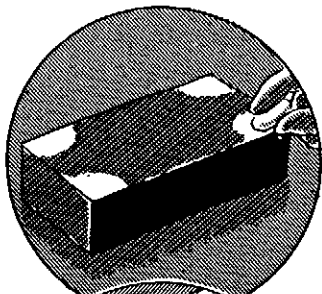

5. Move the gage so that the scriber passes over one corner of the work, and, at the same time, turn the adjusting screw (Fig. 298), thereby bringing the scriber to the work gradually. Obviously, the scriber touches the work when it leaves a light line on the chalked corner, but it is also possible to "feel" when the scriber touches.

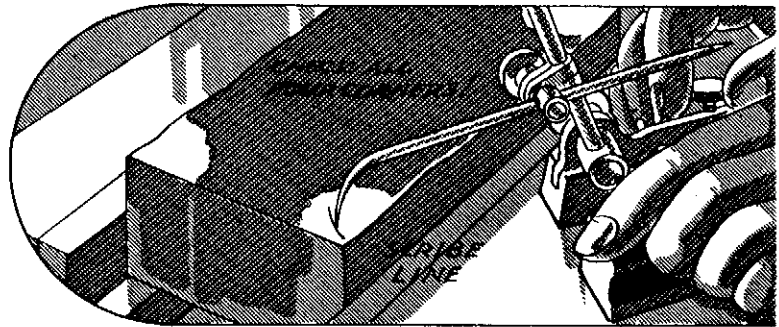
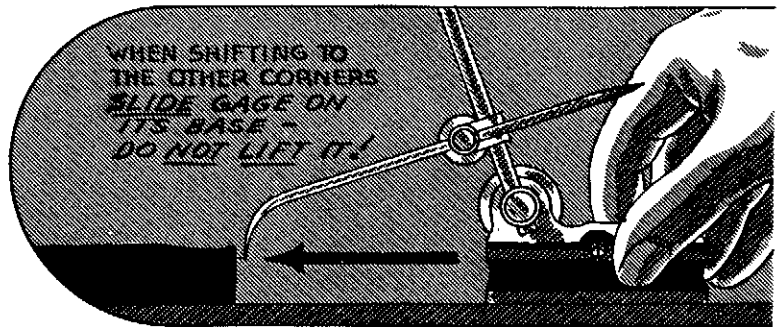

FIG. 298

6. In order to compare the height of the other corners with the one to which the scriber has been adjusted, do not lift the surface gage, but slide it on its base instead. In this way the scriber is brought to the work from the side, and its setting will not be changed if a higher corner is encountered, as might be the case when the surface gage is lifted and the scriber is brought to a higher corner from above.



WHEN SHIFTING TO
THE OTHER CORNERS
SLIDE GAGE ON
ITS BASE -
DO NOT LIFT IT!

7. Observe which of the corners is the lowest so that the tool may be adjusted to this place for taking the cut.



SET TOOL FOR THE
LOWEST CORNER!

HOW TO LEVEL THE SURFACE ON A CASTING HELD IN THE VISE

1. Place the work in the vise with its upper surface as nearly level as possible; then tighten the vise temporarily, applying only enough pressure on the work to hold it in place while its surface is being leveled more accurately.
2. Repeat steps Nos. 1 through 5 above.
3. Bring the scriber to each corner of the work successively and note which one is the highest.
4. Tap the high corner down to the approximate

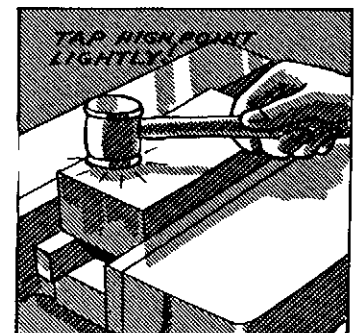

TAP HIGH POINT
LIGHTLY!

level of the others with a lead mallet; then check all the corners again.

5. Continue to tap the high corner down after each checking made with the gage until the four corners are as nearly the same height as the condition of the casting will permit.
6. When all four corners of the casting cannot be set level because of its warped condition, set those level which are diagonally opposite each other. In this way a balance will be attained between the high and the low corners, and the casting can then be machined to best advantage.
7. Tighten the vise sufficiently to hold the work during the cut. Recheck the work, however, after tightening it to make certain that its position in the vise has not changed.
8. If the work is likely to move down in the vise as a result of the cutting pressure, place shims under the parts of the job that do not rest on parallels or on the vise. (Refer to page 114 and Fig. 299.)

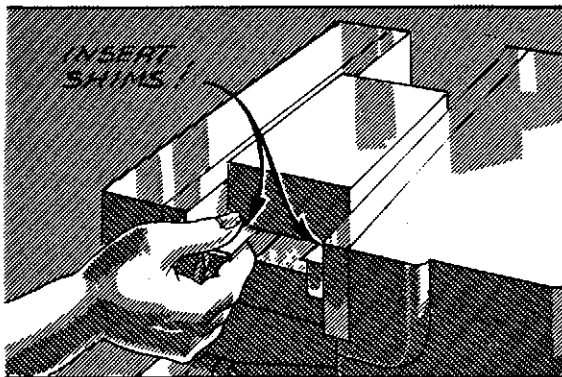

FIG. 299

NOTE: When it is necessary to level a finished surface accurately, instead of leveling a rough surface approximately, a dial indicator can be used on the surface gage in place of a scriber. (Refer to Fig. 300.)

HOW TO SCRIBE LAYOUT LINES ON WORK HELD IN THE VISE

1. Rub chalk on the ends and on the sides of the work.
2. Repeat steps Nos. 1 and 3 on page 206.
3. Hold a scale in a vertical position with one end on a parallel which supports the work, or on the bottom of the vise if the work has been set thereon (Fig. 301).
4. Set the point of the scriber to the dimension on the scale which coincides with the thickness of the finished work.
5. Scribe a line on the side of the cast-

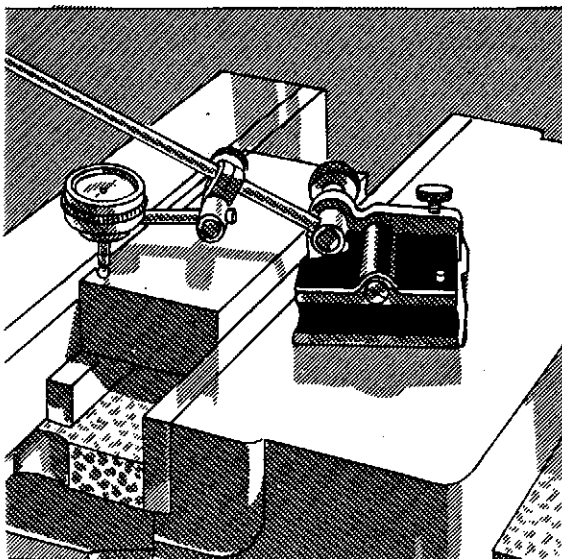

FIG. 300

ing from which the cut is to be started, drawing the base of the surface gage over the top of the vise jaw, and, at the same time, keeping the scriber in contact with the side of the work (Fig. 302).

6. If a line must be scribed on another face of the work which is inaccessible to the surface gage in its present adjustment and location, transfer the gage to another true surface and readjust the scriber point to the first line scribed.

HOW TO SET UP WORK ACCORDING TO A LAYOUT

1. Clamp the work in the vise temporarily with the layout line which indicates the finished surface as nearly level as it is possible to set it by eye (Fig. 303).
2. Follow the instructions given in steps Nos. 1 and 3 on page 206.
3. Place the surface gage on the surface which has been prepared for its use; then adjust the point of the scriber to one end of the layout line (Fig. 304).
4. Slide the surface gage to the opposite end of the layout line and note any variation between the height of the line and the scriber.
5. Tap this end of the work up or down, as required, to bring the layout line level with the scriber point.
6. Continue to check and adjust the work in the same way until there is no apparent deviation in the height of the line from end to end.
7. Tighten the work securely in the vise, and, as a precaution, check it again after tightening it in order to detect any shifting of the work which may have occurred.

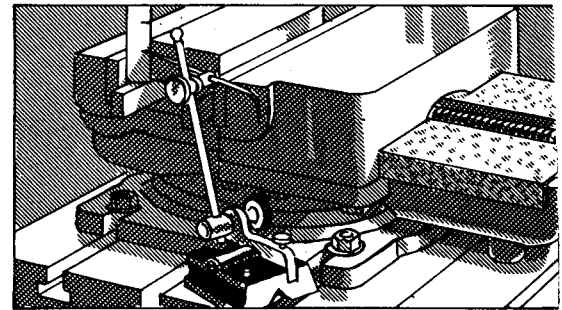

FIG. 301

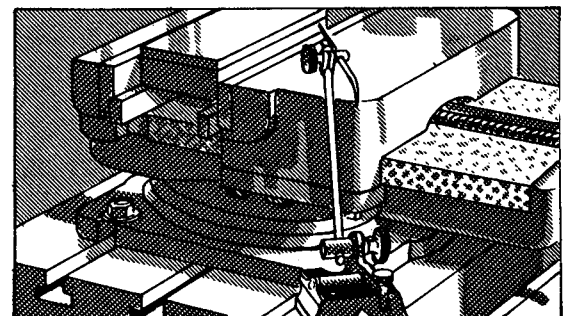

FIG. 302

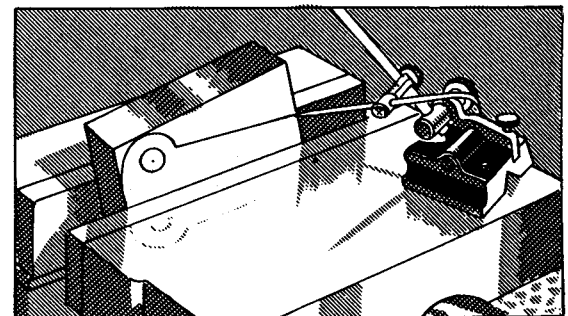

FIG. 303

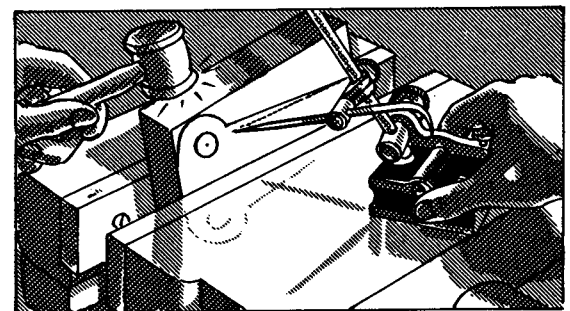

FIG. 304

HOW TO SHAPE VERTICAL SURFACES

PROCEDURE

HOW TO MOUNT THE WORK IN THE VISE FOR A VERTICAL CUT

1. Bolt the vise to the table, if it is not already mounted on the machine, selecting from the several methods given in How to Mount the Shaper Vise on page 119, the one which is appropriate for mounting a vise having this kind of base.
2. Swivel the vise on its base, if necessary, so that the jaws are at right angles to the stroke or, as expressed in another way, so that the jaws are parallel with the face of the column.
3. Place the index line on the vise over the zero on the base as directed in How to Set the Jaws at 90° to the Stroke on page 124, and when a more accurate setting is desired, follow the directions given in How to Set the Vise at 90° to the Direction of the Stroke With an Indicator on page 133.

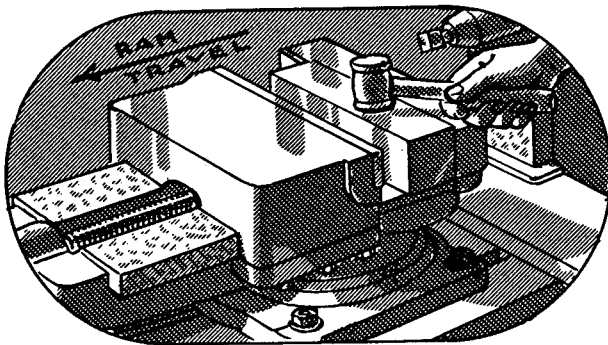

4. Place the work in the vise — on parallels if it must be raised — so that the end which is to be squared extends approximately one-half inch beyond the right side of the vise. At the same time, place a strip of paper under each end of the work if it rests on the vise or under each corner of the work if it rests on parallels.

5. Tap the work down in the vise with a lead mallet, pulling lightly on the paper strips underneath to ascertain whether or not it has been properly seated, for in order to have the ends planed square with its sides, the work must be placed parallel with the table as well as at right angles to the stroke of the ram. (Refer to page 184.)
6. Bevel the edges of the work at the end of the cut, almost to the depth of the cut. (Refer to page 196.)

HOW TO MOUNT THE WORK ON THE TABLE FOR A VERTICAL CUT

1. Remove the vise from the table as directed in How to Dismount the Shaper Vise on pages 122 and 123.

CAUTION

Its weight and its size make help imperative for lifting the vise from the machine table.

2. Thoroughly clean the table; then remove any burrs or high spots from its upper surface with a smooth file.
3. Clean the surfaces of the work, and, at the same time, inspect these surfaces for burrs which must be removed before placing the job on the machine table.
4. Place a single thickness of paper on the shaper table for the purpose of increasing the amount of friction between the work and the table and reducing the likelihood of the job shifting during the cut (Fig. 305).
5. Place the work on the table with one of its sides as nearly parallel with the face of the column as it is possible to set it by eye. At the same time, allow one end to extend about one-half inch beyond the right side of the table.

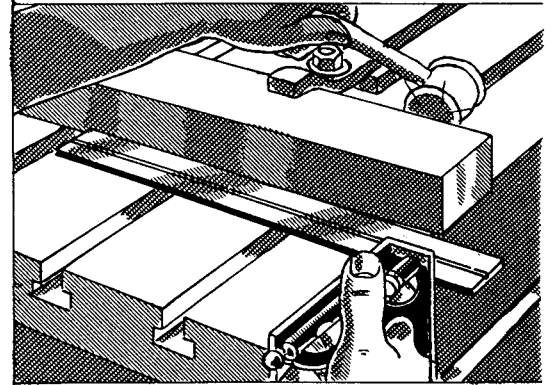

FIG.305

6. Clamp the work to the table lightly, using straps and the shortest bolts possible which will still provide a full thread for the nut. If gooseneck clamps (page 107, Fig. 107) are available, use these, for their construction precludes the possibility of the bolt and the nut extending any further above the work than the clamp itself. This feature — that of having the top of the bolt no higher than the strap — is important, especially during the vertical cuts, inasmuch as any extension of the bolt above the work adds to the distance the tool slide must be extended from the head during the cut.
7. To make certain that there are no burrs on the side of the table which is to be used for squaring the work, rub a smooth file over this surface and wipe it with a cloth to remove the filings, for the surface against which the square is placed must be clean.
8. Place the head of a combination square against the side of the table just cleaned, and extend its blade so that it comes alongside of the work (Figs. 305 and 306).
9. Press the head of the square firmly against the side of the table and carefully slide it toward the work, noting which end of the blade comes in contact with the work.

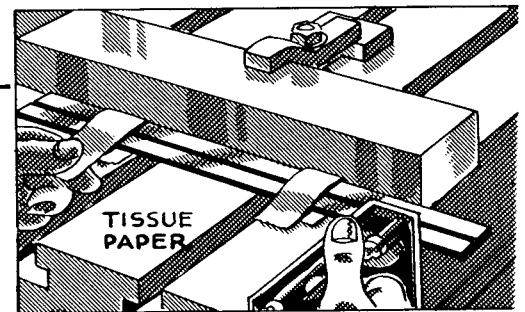

FIG.306

10. Tap the end of the work which does not touch the blade toward the square until the opening between the work and the square disappears and the

work is parallel with the blade, an indication that the work is now at right angles to the ram.

11. To check the alignment of the work more closely and positively with the square, place a piece of tissue paper between the work and each end of the blade. Then, if necessary, tap the work as before, until the same amount of "drag" is felt on both pieces of paper when they are withdrawn from between the blade of the square and the work (Fig. 306).

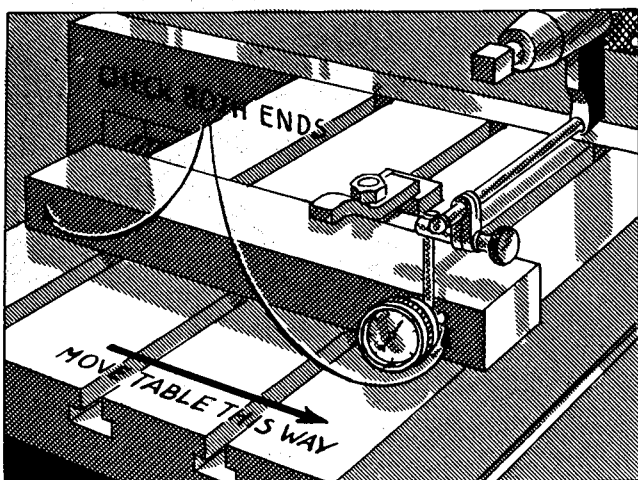

FIG. 307

12. To align the work very accurately, use a dial indicator instead of a square. Clamp it in the tool post (page 134, Fig. 163) with its contact point against the front face of the work. Then move the work crosswise by means of the cross-feed screw to determine the amount of misalignment, and subsequently adjust the work in the same manner as before, until the indicator hand remains stationary during movement of the work from side to side (Fig. 307).

13. Tighten the work securely, and, as a precaution, check its alignment again to ascertain whether or not its position changed when the bolts were drawn down tightly.

14. Place a suitable stop in front of the work at the right and another in the rear of the work at the left (Fig. 308) as an additional precaution against shifting of the work during the cut. Refer to How to Use Stops on page 139.

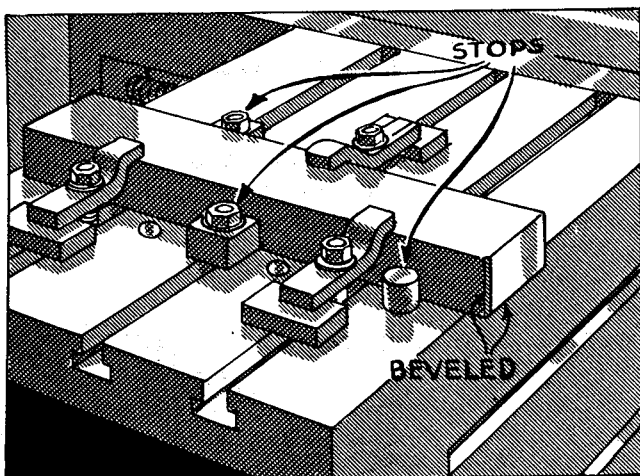

FIG. 308

15. Bevel the edge at the front of the work with a file, almost to the depth of the cut.



Oil the shaper as directed in How to Oil the Shaper, beginning on page 47.

HOW TO ADJUST THE CUTTING TOOL AND THE TOOL HEAD

1. Read the description of the vertical cut beginning on page 184.
2. Set the tool head at right angles to the machine table by placing opposite the index line on the ram whichever of the graduations — zero or 90° — will cause the head to be placed square with the table. Then tighten the clamping bolts just enough to hold the head in this position. Refer to How to Adjust the Tool Head on page 91.
3. Check the accuracy of this setting with a square. Hold the head of the square down firmly against the finished surface (on the table or on the vise); then carefully slide the square to the side of the tool slide and note whether or not it is parallel with the blade of the square.
4. Tap the head in one direction or the other with the palm of the hand or with a soft hammer, if an opening is visible between the square and either end of the tool slide, for this condition is an indication that the head is not square with the table (Fig. 309).
5. Tighten the clamping bolts on the head securely when the head is square.
6. Loosen the binder bolt on the clapper box and swivel its upper end to the right to the limit of the slot; then tighten the bolt again. Refer to Functioning of the Clapper Box on page 186.
7. Note the height of the vertical surface which is to be planed. Run the tool slide up far enough at the start of the cut so that when the cut has been completed and the tool has reached the lower end of the vertical surface (Fig. 310), the slide will not extend much below the swivel block.
8. Measure the opening in the tool post so that either a forged tool or a tool holder of the correct size may be selected.
9. Determine whether a straight or an offset tool holder can be used to better advantage on this cut. Then select a tool bit that has been ground especially for taking a vertical cut on

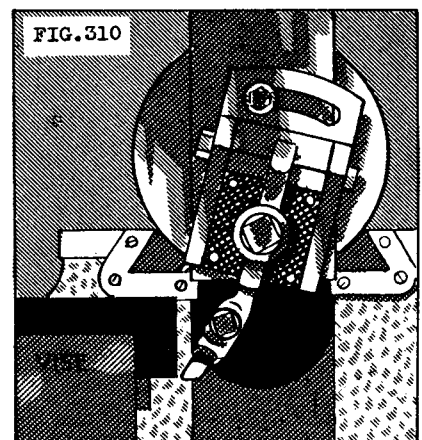
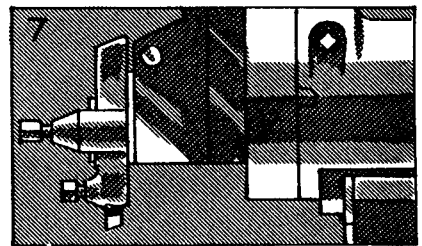
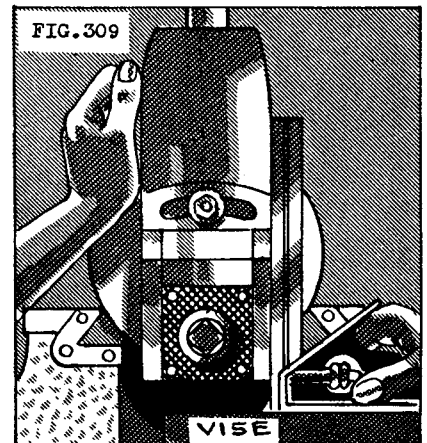
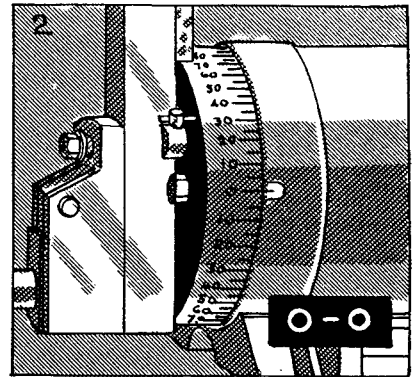

the right-hand end of the job and for cutting the kind of material in the work. If a forged tool is selected instead of a tool holder and a tool bit, its selection too should be based on the type of cut (vertical) which is to be made. Refer to page 166 for the selection of the cutting tool.

10. Clamp the tool holder in the tool post in such a position that the vertical cut can be made without interference between the holder and the job. Furthermore, extend the tool holder beyond the tool block the shortest distance possible for making the cut. In no instance, however, should this distance be less than the height of the vertical cut, if rubbing of the tool slide on the work is to be avoided (Fig. 310).

HOW TO ADJUST THE SHAPER PRIOR TO TAKING A VERTICAL CUT

1. Adjust the position of the cross rail on the column up or down so that a space of approximately one inch is apparent between the ram and the top of the work, or between the ram and the straps and bolts, whichever is higher. Refer to How to Adjust the Cross Rail on page 77.

CAUTION Before raising or lowering the table, loosen the bolts for clamping the cross rail and those for clamping the table support, but tighten them again immediately after the rail has been moved to its new position on the column.

2. Measure the length of the surface which is to be planed; add approximately one inch to this dimension in order to provide for clearance of the work by the cutting tool at both ends of the stroke. (Refer to page 79.)
3. Adjust the ram stroke for a length equivalent to that derived in step No. 2. For adjusting the crank shaper, refer to How to Adjust the Stroke on pages 79 and 80; for the hydraulic shaper, refer to How to Adjust the Stroke and the Position of the Ram on page 92.

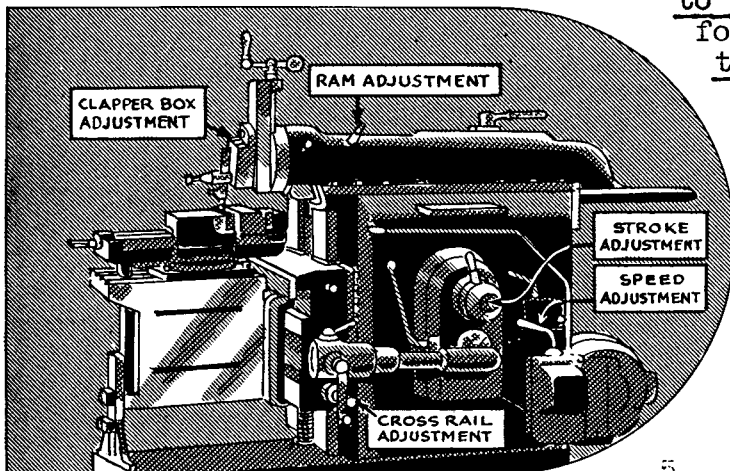

FIG.311

4. Adjust the position of the stroke so that the tool covers the entire surface which is to be planed. When using a crank shaper, refer to How to Adjust the Position of the Ram on page 81; when using a hydraulic shaper, use the reference given in step No. 3.

5. Consult the table, Allowable Cutting

Speeds — Feet Per Minute on page 308. From this table, determine the cutting speed in feet per minute which is to be used. Base the decision on the kind of material to be planed, and on the type of cut, whether roughing or finishing, which is to be made with a High-Speed Steel cutting tool.

NOTE: Most cone-driven shapers are unprovided with charts such as appear on the direct-driven shapers. For this reason step No. 5 may be omitted when a cone-driven shaper is used, inasmuch as the cutting speed in feet per minute cannot be determined when the number of ram strokes per minute is unknown. (Refer instead to pages 83 and 84.)

6. Determine the number of strokes per minute which will result in a cutting speed in feet per minute approximately the same as that decided upon in step No. 5. (Refer to page 295.)
7. Read page 82; then select from the procedures given for setting the speed on various types of shapers, the one which is appropriate for the shaper being used, and adjust the shaper for the number of strokes per minute decided upon in step No. 6. For setting the speed on a crank shaper, refer to How to Adjust the Speed of the Ram on pages 83 to 85; for setting the speed on a hydraulic shaper, refer to How to Adjust the Speed of the Ram on a Hydraulic Shaper on page 94.

CAUTION

Do not attempt to shift gears while the shaper is in operation.

8. To determine whether or not the cut can be made without any part of the ram striking the work, feed the tool down for the length of the cut with the ram stationary; then carefully move the ram through one complete stroke by hand.

HOW TO TAKE THE ROUGHING CUT (VERTICAL)

1. Consult the blueprint or the job layout for the purpose of determining how much material is to be removed by the tool.
2. When both ends must be squared and the job must be planed to a definite length at the same time, plan to remove approximately one half the excess material from each end. Refer to The Roughing Cut on page 181.
3. Bevel the vertical edges at the ends of the cut to prevent breakage of the corner below the finished surface.
4. To set the tool for a cut of the desired thick-

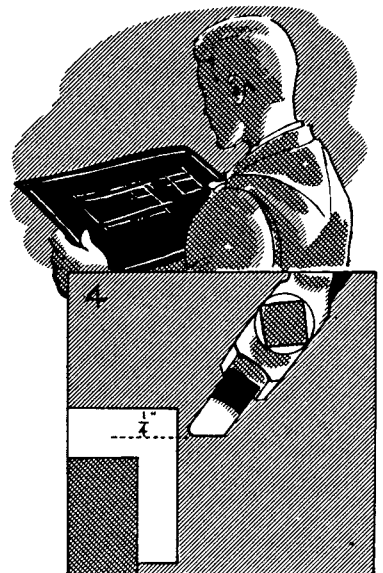

ness, move the work to the left of the tool; then, by means of the down-feed screw, move the tool down about 1/4" from the top of the vertical surface.

5. Now, by means of the cross-feed screw, move the work toward the tool carefully until they just barely touch; then set the micrometer dial on the cross-feed screw to zero.
6. Raise the tool so that it just clears the top of the job; then move the work to the tool for the desired cut, measuring its thickness by means of the graduations on the dial on the cross-feed screw.

NOTE: During the vertical cut, the tool is frequently extended somewhat farther from the tool post than usual so that the cut can be made to the bottom of the work without interference between the tool slide and the job. For this reason both the rate of feed and the width of the cut should be somewhat less than they are for horizontal planing.

HAVE ENTIRE SET-UP CHECKED BY YOUR INSTRUCTOR



OIL

Oil the shaper as directed in How to Oil the Shaper, beginning on page 47.

7. Start the shaper; then feed the tool down carefully by hand until the cut has been started just far enough to make its width apparent.

CAUTION

Keep the face and the eyes a safe distance from the work, or, better still, wear goggles as a protection from flying chips.

8. Stop the shaper for the purpose of measuring the work and making certain that the work in its present position will not be cut undersize because too heavy a cut is removed.
9. Start the shaper again; then feed the tool down about .010" at the end of each return stroke of the tool, continuing the feeding until the entire surface has been planed.

NOTE: Inasmuch as both the size of the cut and the quality of the finish desired may vary considerably, it is impossible to specify a rate

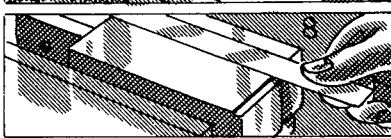
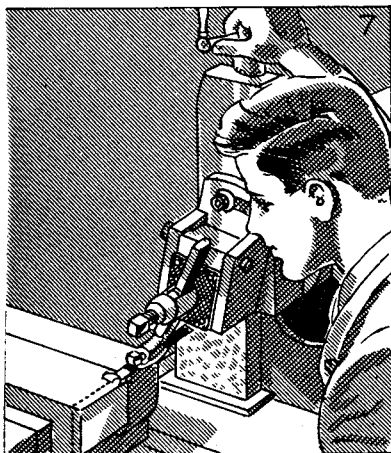
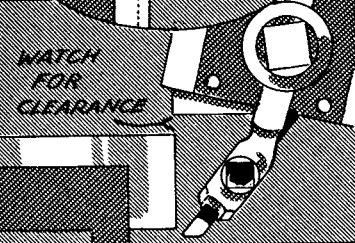
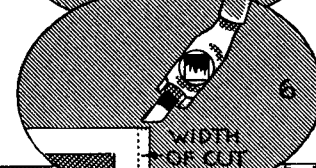
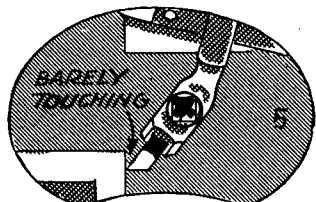

of feed suitable for every combination of these factors. The recommended procedure, therefore, is to feed the tool to the work slowly at first, and then to increase the rate when the action of the tool makes it apparent this can be done with safety.

CAUTION Keep the fingers and hands away from the cutting tool while the shaper is in operation. It is extremely dangerous to place the hands directly behind the vise, or the work, at any time while the shaper is in operation.

10. When the cut has been completed, stop the ram in its rearmost position and raise the tool to the position for starting the cut, that is, to the top of the work.
11. File the burrs from the edges of the work preparatory to testing it with a square; then wipe the upper surface and the end in order to remove the filings and any other foreign material which may be present.
12. Test the work with a try square as shown in Fig. 312 to see if the end has been planed square (at right angles) to the upper surface.

NOTE: When the surface of the work is unusually rough and irregular before it is machined, this condition is very likely to be reflected to some extent on the finished surface as a result of spring in the tool. A second, light cut, made for the purpose of removing these irregularities, is advisable for correcting this condition. Then a true surface which indicates the actual position of the head in relation to the upper surface of the work will be available for testing with the square.

13. When testing the work with a square, press its beam down firmly against the upper surface of the work and carefully move the blade toward the end just planed. Then note whether or not the vertical surface is parallel with the blade.

NOTE: If the work and the tool head have been set up as directed, the end should be square with the top of the work when the cut has been completed. If this is the case, the blade of the square will touch the end from top to bottom and neither an opening nor light will be visible between the work and the blade of the square. Obviously then, the work is not square

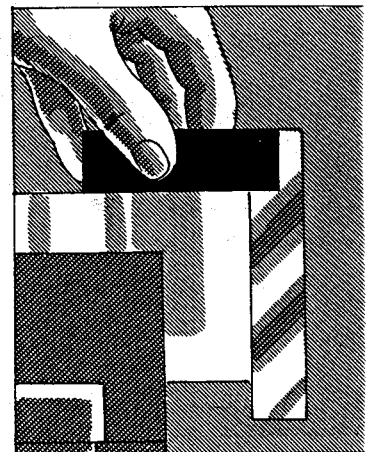
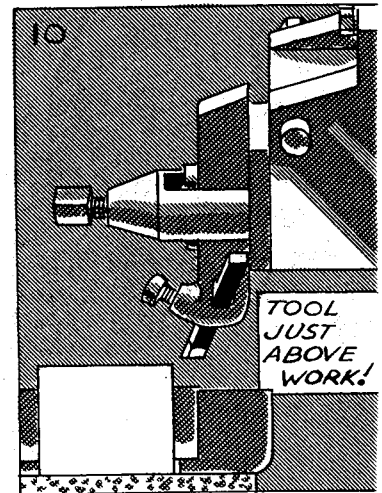
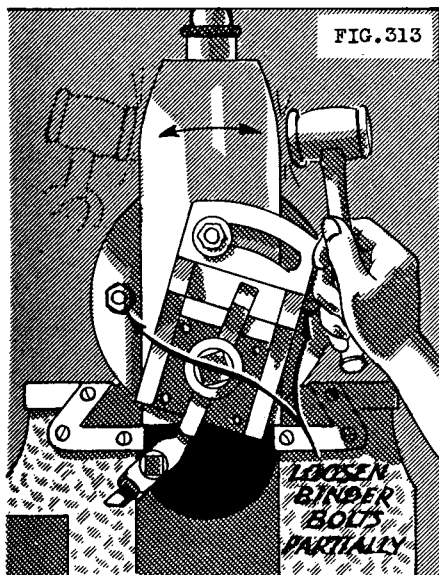

FIG. 312

when light is visible between the square and the end of the work. To correct this condition, the tool head must be swiveled slightly in one direction or the other depending upon whether the light is visible at the upper or the lower end of the blade.



14. When the position of the tool head is to be changed only a small amount for correcting a slight inaccuracy in the cut, partially loosen the binder bolts holding the swivel block to the ram, and swivel the head in the direction desired by tapping it lightly with a block of wood or lead: to the left when the opening occurs at the lower end of the square and to the right when the opening occurs at the upper end (Fig. 313). The number of adjustments required to make the work square will depend upon the operator's ability to estimate the amount of swiveling needed on the head to produce the desired correction in the cut.

15. Reset the work to the tool after each adjustment of the head inasmuch as their relationship changes each time the head is swiveled. Then take another light cut and check the result with a square as before.

CAUTION

When taking several trial cuts to square the work, be careful not to cut the work undersize.

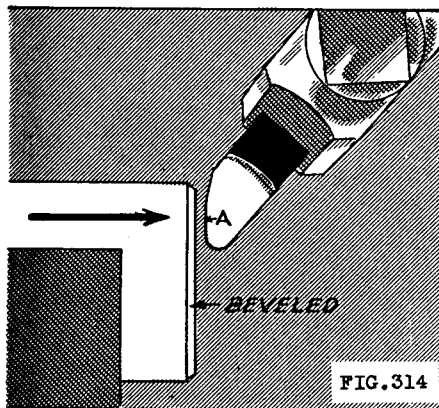

HOW TO TAKE THE FINISHING CUT (VERTICAL)

1. Replace the roughing tool with a left-side finishing tool suitably ground for cutting the kind of material in the job. Locate the tool in the tool post according to instructions given in steps Nos. 7 through 10 on pages 213 and 214. Refer to page 166 for the selection of the tool and to page 182 for a description of the finishing cut.
2. File a small bevel on the edges of castings to prevent the sand and scale on their surfaces from dulling the keen cutting edge of the finishing tool.
3. By means of the ram, place the tool opposite the vertical surface, and, by means of the down-feed screw, lower the tool so that it extends alongside this surface; then, using the cross-feed screw, move the work over until it almost touches the tool.
4. Adjust the tool in the tool post so that its cutting edge at A

is parallel with the vertical surface as shown in Fig. 314; then tighten the tool-post screw.

5. After placing a feeler against its end, continue to move the work carefully toward the tool until a slight "drag" is required to withdraw the feeler from between the work and the tool. Now set the graduated collar on the cross-feed screw to zero.
6. Raise the tool so that it clears the job; then move the work to the right a distance equivalent to the thickness of the cut (about .010") and the feeler, using the micrometer collar to measure the distance.
7. Start the shaper and feed the tool down at the end of each return stroke of the ram, using a fine feed when finishing steel and about a half turn of the down-feed screw when finishing cast iron.
8. File the burrs from the edges; wipe the surfaces clean; then test the work with a square. (Refer to page 217, Fig. 312.)
9. To square the opposite end of the work, reverse its position in the shaper, repeating steps Nos. 4 through 6 on page 210 for work held in the vise, or, repeating steps Nos. 2 through 15, beginning on page 211, for work clamped to the table.
10. Replace the finishing tool with the roughing tool, repeating steps Nos. 7 and 10 on pages 213 and 214.
11. Take the roughing cut as directed in How to Take the Roughing Cut (Vertical) on page 215, allowing .010" to .015" on the overall length of the work for the finishing cut.
12. Replace the roughing tool with the finishing tool used for the opposite end and proceed to take the cut as directed in steps Nos. 1 to 8 above.
13. Measure the overall length of the work, and, if the job is over-size, take additional cuts, using the micrometer dial on the cross-feed screw to control the amount of metal to be removed.
14. When the job is finished, brush all chips from the machine, and return the parallels and other accessories to their proper places in a clean condition.

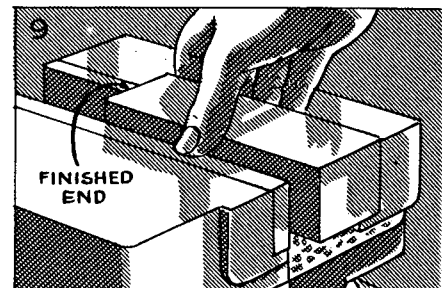
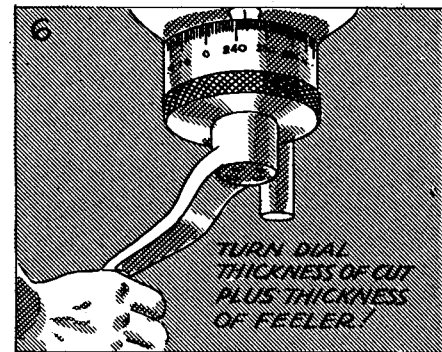
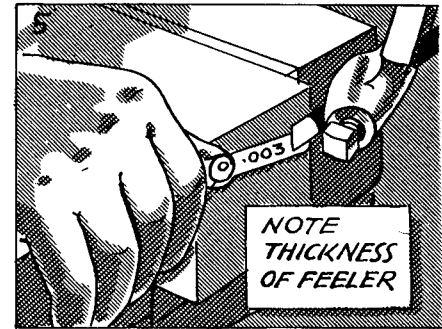

HOW TO SHAPE COMBINED HORIZONTAL *and* VERTICAL SURFACES

PROCEDURE

1. Read the description of the combined horizontal and vertical cuts beginning on page 187.

NOTE: Squaring of a shoulder is usually preceded by horizontal and vertical cuts, and, as a rule, the shoulder is squared immediately after these cuts have been made and before the work is removed from the shaper. Therefore, directions for mounting the work will not be given at this time. However, when the job has been removed from the machine and it must be replaced for squaring the shoulder, then either directions given on page 210 or those given on pages 211 and 212, whichever are most appropriate, may be used.

2. Set the tool head at right angles to the table, and swivel the clapper box to the right as for a vertical cut. Refer to steps Nos. 1 through 8 on page 213.
3. Select a round-nosed roughing tool suitably ground for taking a horizontal cut on the material in the job, a tool with its cutting edge on the left side and with a relatively small radius on the corner (page 166).

4. Mount the tool holder in the tool post, allowing it to extend just far enough for the tool to reach the lower horizontal surface without having the tool slide strike the job. At the same time, place the tool holder in a position (slightly angular) which will enable the tool to cut to the corner without having its holder rub on the vertical surface (Fig. 315).

5. Make certain that the length of the stroke, its position relative to the cut, and also the speed of the shaper have been adjusted to suit the job. Refer to How to Adjust the Shaper Prior to Taking a Vertical Cut on page 214.

CAUTION

Carefully move the ram through one complete stroke to make certain that the above adjustments have been made correctly.

6. Take a series of horizontal cuts and rough out the work to within $1/64$ " of the final dimensions on both the horizontal and the vertical surfaces.

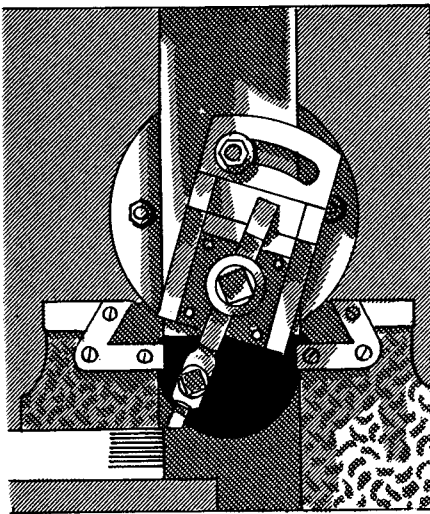
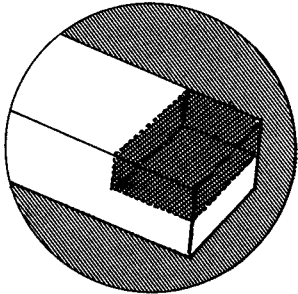

FIG. 315

7. Remove the roughing tool and replace it with one ground especially for squaring the corner. Surfaces A and B on this tool, Fig. 316, form an angle slightly less than 90° .
8. Adjust this tool to the work so that a slight opening is still apparent at B when the point just barely touches a horizontal surface and so that a similar opening is apparent at A when the point touches a vertical surface, such as the end of a scale placed against the side of the tool as shown in Fig. 316.

NOTE: Although it is intended primarily for squaring right-angle corners, a tool ground like the one shown in Fig. 316 functions equally well as a finishing tool for both the horizontal and the vertical surfaces which form a shoulder. The procedure for its use in this manner has been explained here, and the procedure which is to be followed when a tool of this kind is used only for squaring the shoulder has been explained on page 223.

9. When the height of the shoulder must be accurately maintained, set the tool so that it just barely touches a feeler placed on the upper surface of the work; then set the micrometer collar on the down-feed screw to zero.
10. Move the work to the left so that it is no longer under the tool; then use the micrometer dial and feed the tool down a distance equivalent to the height of the shoulder and the thickness of the feeler.
11. Lock the tool head in place, reset the micrometer dial at zero and start the shaper.
12. Adjust a rate of feed which will produce the kind of surface finish desired, engage the automatic feed, and then take a finish cut on the horizontal surface.

FIG. 316

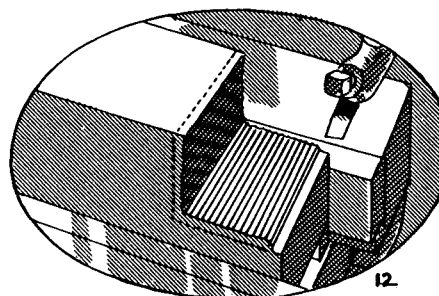
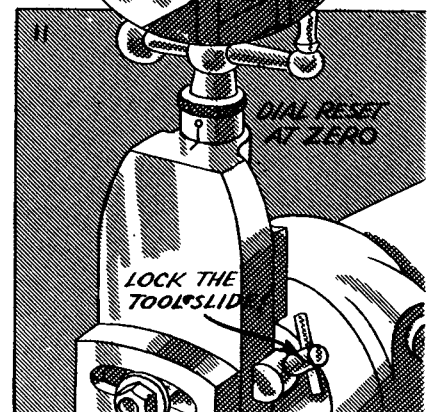
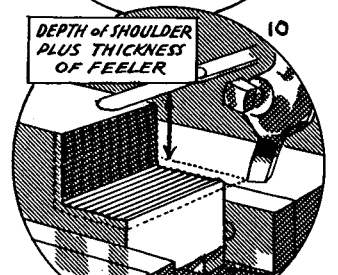
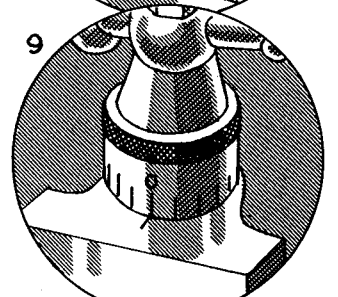
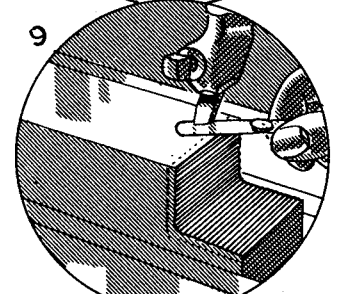
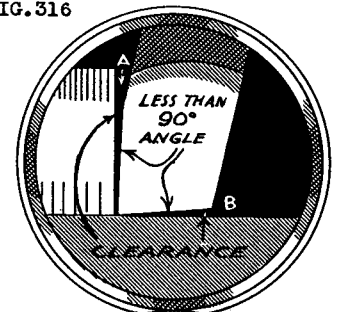

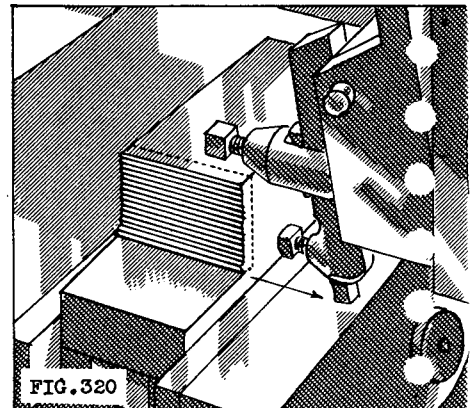
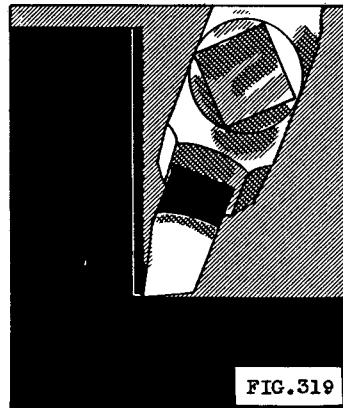
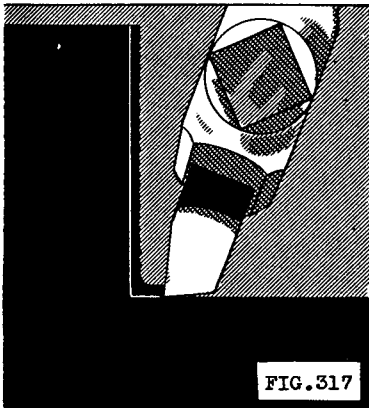

13. Disengage the automatic feed just before the tool reaches the fillet (Fig. 317). From this place use the hand feed and move the work toward the tool more slowly, tapping lightly on the handcrank with the palm of the hand to control to best advantage the amount of feed per stroke (Fig. 318).
14. Continue the hand feeding until the metal left in the corner by the round end on the roughing tool has been removed and until the tool has cut almost to the layout line indicating the location of the shoulder (Fig. 319). Then stop the shaper in its rearmost position (Fig. 320).

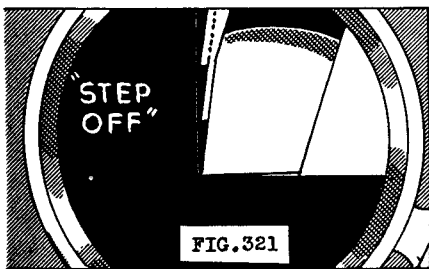

NOTE: If a large fillet has been left in the corner, it may be necessary to "step off"; that is, it may be desirable to remove the fillet by taking several light cuts rather than by taking a single heavy one (Fig. 321).

15. Raise the tool to a position slightly above the vertical surface; then adjust the work to the tool preparatory to taking the vertical cut.

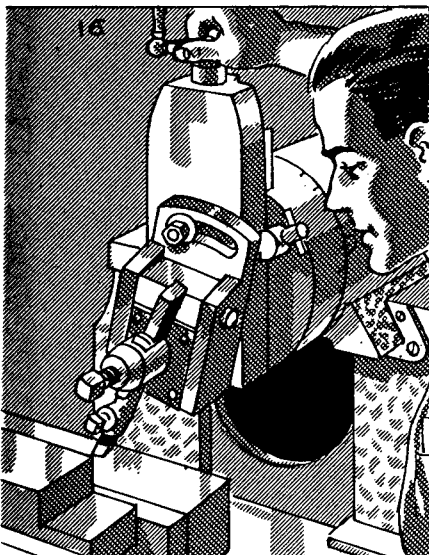

16. Start the shaper and then feed the tool down carefully until the cut is just started. Make further adjustments of the work, if necessary, so that the final setting will result in a cut which splits the vertically scribed line.
17. Whenever the dimension from the end of the work to the shoulder must be maintained accurately, this distance can be measured by using the graduations on the micrometer collar on the cross-feed screw. Move the end of the work against the left side of the tool (Fig. 322), using a feeler between, and set the micrometer collar to zero (Fig. 323). Then raise the tool above the vertical surface

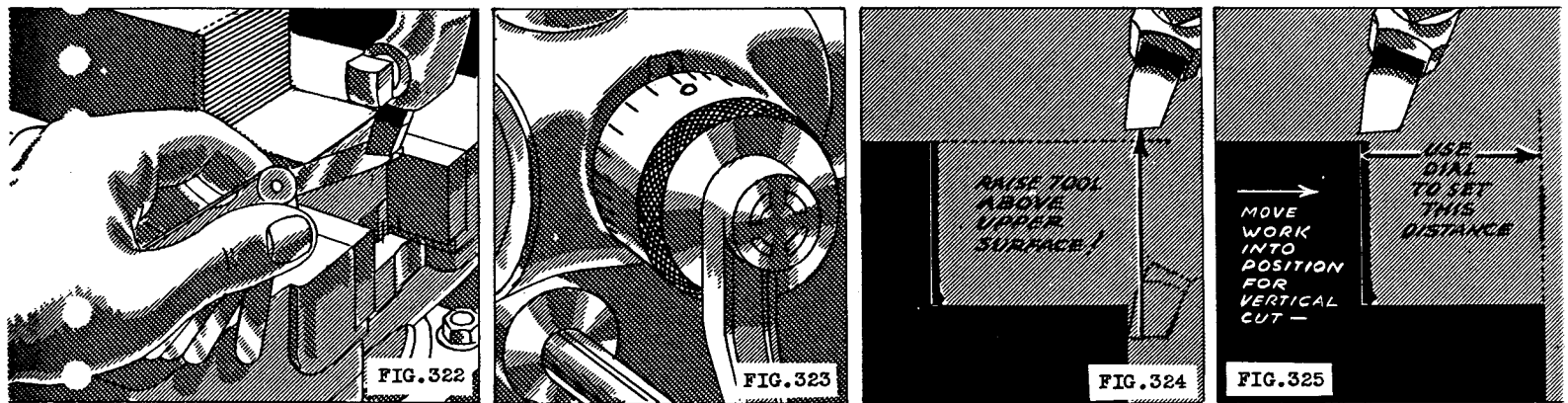

(Fig 324) and move the work over the number of thousandths required to locate it in position for taking the finishing cut on the vertical surface (Fig. 325), not forgetting to include the thickness of the feeler.

18. Decide upon the rate of feed to be used, and then feed the tool down this distance at the end of each return stroke.
19. Continue to feed the tool down steadily until it reaches the horizontal surface and the zero on the graduated dial on the down-feed screw is again opposite the index line. In other words, the tool should be fed down until it is again in the identical vertical position it occupied when the finishing cut was made on the horizontal surface. (Refer to step No. 11 above.)
20. Slowly feed the shoulder away from the tool by hand so that the surface in the corner merges with the remainder of the horizontal surface. When the tool is fed down, the slight angle at which the lower surface of the tool has been set is duplicated on the horizontal surface in the corner (Fig. 326) and, consequently, point A is slightly higher than the remainder of the horizontal surface. It is for the purpose of removing this point that the work is fed away from the tool slowly after the tool has reached the horizontal surface (Fig. 327).

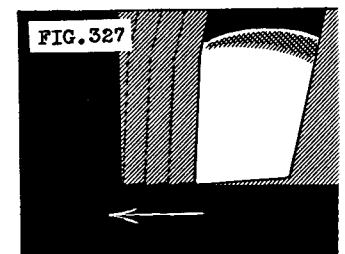
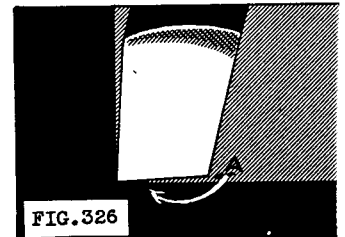

NOTE: When the finishing cuts have been made on both the vertical and the horizontal surfaces with a round-nosed tool, consequently leaving a fillet in the corner, the shoulder can be squared as follows:

1. Select a tool similar to the one recommended in step No. 7 above.
2. Set the tool in relation to the work as directed in step No. 8 above.

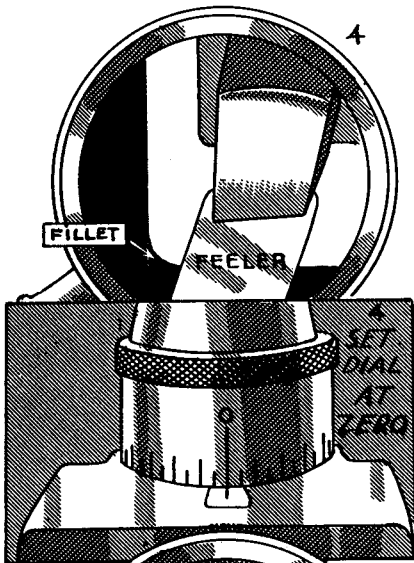

3. Make certain that the length of stroke, its position relative to the cut, and the speed of the shaper have been adjusted to suit the job.
4. Place a feeler of a known thickness (in thousandths of an inch) on the horizontal surface under the tool and then move the tool down carefully (with the ram stationary) until a slight drag is apparent when the feeler is withdrawn; now set the micrometer collar on the down-feed screw at zero.

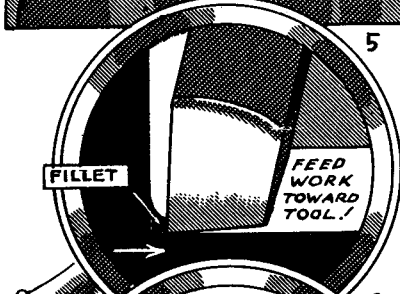

5. Start the shaper and feed the work toward the tool by hand until the side of the tool is almost in line with the vertical surface.

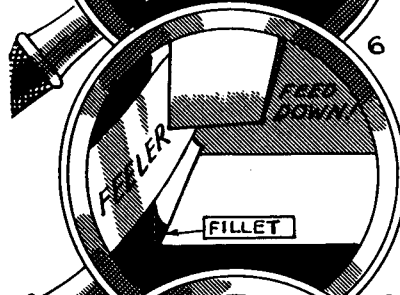

6. Raise the tool so that its point is above the fillet; then carefully move the work toward the tool, tapping lightly on the crank on the cross-feed screw until the tool just barely scrapes the shoulder.

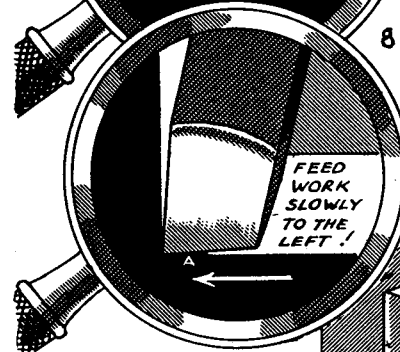

NOTE: This adjustment can also be made by placing a feeler between the work and the tool while the ram is stationary and then moving the work toward the tool a distance in thousandths equal to the thickness of the feeler. This distance can be measured by means of the micrometer dial on the cross-feed screw.

7. Feed the tool down carefully until it reaches the horizontal surface and until the zero on the micrometer dial on the down-feed screw has been turned beyond its index line a distance in thousandths equal to the thickness of the feeler used under the tool when it was adjusted to the horizontal surface in step No. 4.

8. Turn the handcrank on the cross-feed screw in a clockwise direction, feeding the work slowly to the left so that the tool will remove the slight projection at A and cause the surface in the corner to merge with the remainder of the horizontal surface. (Refer to Fig. 327.)

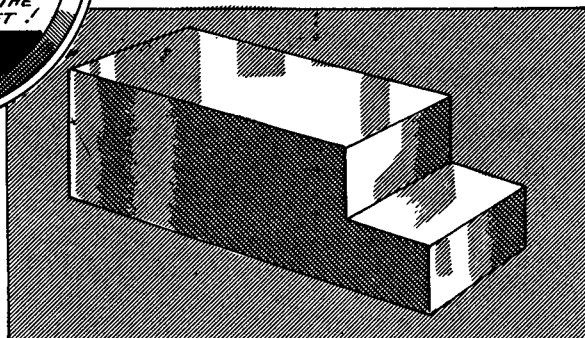

DESCRIPTION OF ANGULAR CUTS

Unit 1-T53(B) Pages 225 to 234

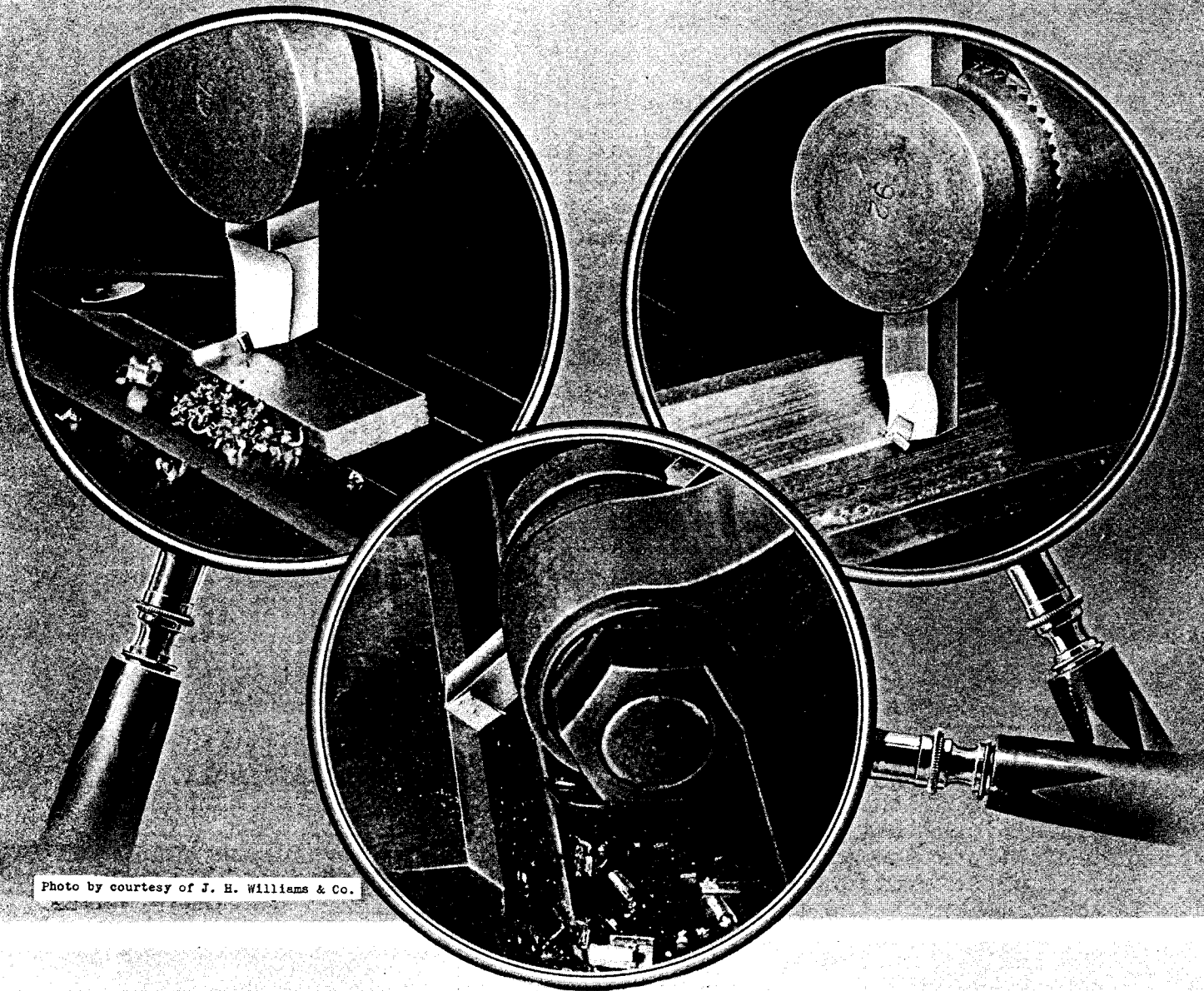

Photo by courtesy of J. H. Williams & Co.

UNIVERSITY OF THE STATE OF NEW YORK
STATE EDUCATION DEPARTMENT
BUREAU OF INDUSTRIAL AND TECHNICAL EDUCATION

DESCRIPTION *of* ANGULAR CUTS

OBJECTIVES OF UNIT

1. To indicate the various methods used to produce angular surfaces or cuts.
2. To describe the two methods used to graduate the tool head.
3. To determine the angle that the head must be swiveled to correspond to the angular surface of the work.

INTRODUCTORY INFORMATION

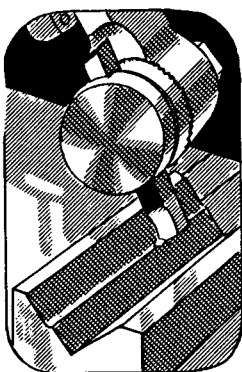

Angular surfaces can be produced in the shaper by using three principal methods: (1) the work may be held in the machine in such a position that a horizontal or a vertical cut will form an angle with an adjacent surface; (2) the cutting edge of the tool may be set at an angle to the vertical or the horizontal axis of the machine and the moving tool brought into proper relation to form an angular surface; and (3) the tool head may be swiveled and then the tool fed in an angular direction by the down-feed crank, guided by the tool slide.

As the first two methods depend upon the arrangement of the work and the setting of the tool, more detailed instruction will be given in the following unit (page 237). The setting of the tool head, however, requires some knowledge of angular measurements.

The cutting of angular surfaces, or cuts, is frequently confusing to the beginner. The angles, though, are not difficult to determine if the operator is familiar with some of the simple definitions that are used when dealing with angular cuts. These definitions are easily understood and they are invaluable when used to determine the relationship of the machined surface to the angle at which the tool head must be set. However, the indicated angle on the drawing or blueprint is not always given in terms of the angle that the head must be swiveled. For this reason, the angle at which the head must be set is first determined and then the head set to correspond with the angular surface of the work.

Finally, there is one other item to be given attention, and that is the method of graduating the swivel block. Unfortunately for the beginner, there are two methods of graduating the head, both of which are described in this unit. Both methods, however, are easily understood; the only difficulty is that they are different, and this must be taken into consideration.

DESCRIPTION OF ANGULAR CUTS

Angular surfaces are those which approach each other from different directions in contrast to those which are parallel with each other. The definition should be limited to exclude the right angle because, in shaper work, the right angle is formed by the combination of the horizontal and the vertical cuts. It should be understood then that when cuts are made at an angle with the horizontal or the vertical, they are called angular cuts.

Correctly speaking, angular cuts can be made on the shaper only when the head is swiveled either to the right or to the left of the vertical position. The cut is then made by feeding the tool along the surface with the tool slide after the head has been swiveled to the desired angle (Fig. 328).

Practically, however, it is not always necessary to swivel the head to produce a surface which is machined at an angle to another surface. There are several other methods which can be used to do this.

1. The work may be set to a line which has been scribed on the work to form an angle with another surface. The line is set in a horizontal position with a surface gage and the surface machined to the mark (page 237).
2. The work can be supported on tapered parallels in the vise and a cut taken across the piece in the usual manner. This method is usually used for slight angles or tapers (Fig. 329).
3. Degree parallels placed in the vise offer a convenient method of setting the work at a slight angle with the vertical. When the work is held between the parallels, and a cut is taken across the top of the piece, an angular cut is formed with the sides of the work (Fig. 330).
4. Setting the edge of the tool to suit the angle of the cut is another method of producing an angular surface. The edge of the tool may be set approximately, or a protractor or a gage can be used to set the cutting edge correctly. When these cuts are comparatively narrow, they are often called chamfers (Figs. 331 & 332).

Since the four above methods depend upon the manner

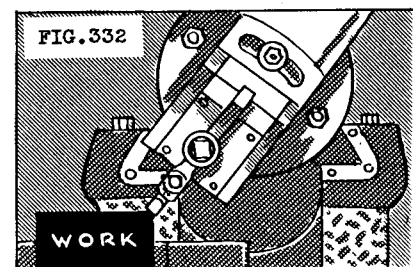
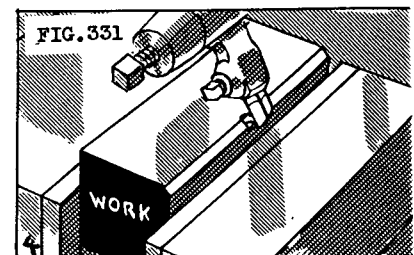
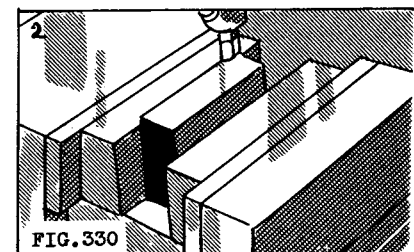
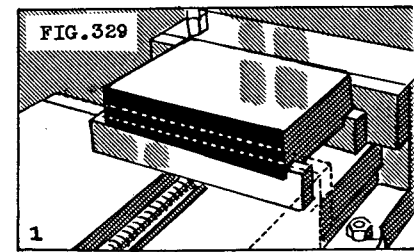
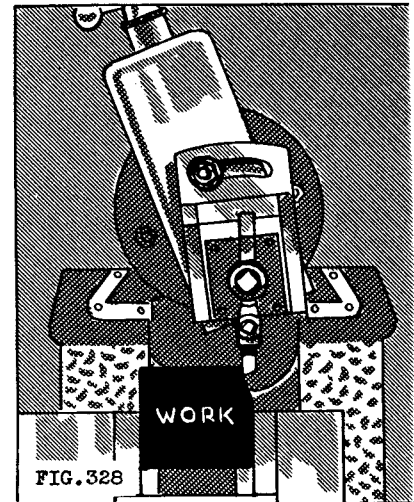

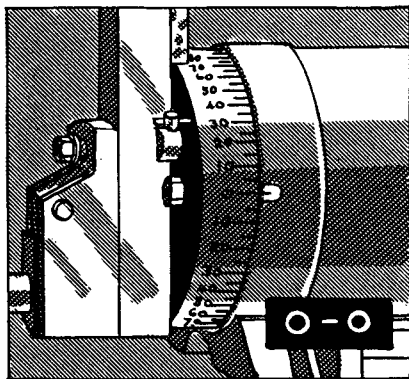

FIG. 333

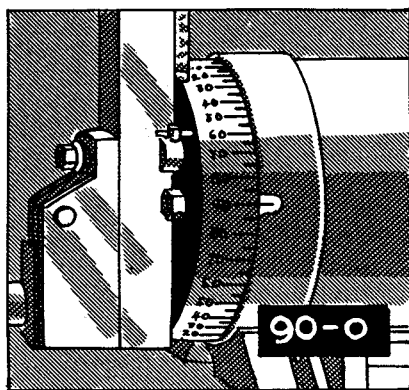

FIG. 334

that the work is held in the shaper vise or the way the tool makes contact with the work, the problem is simply a matter of setting the work or the tool correctly. This is fully described in the next unit.

The setting of the tool head, however, requires some understanding of how the head must be set to correspond to the angular surface of the work.

For setting the tool head in a vertical position, there is a zero mark located on the head of the ram which corresponds with either a zero or 90° graduation on the base.

Those heads which start with a zero graduation when the head is in a vertical position are graduated to indicate an angular position from 0° to 60° on each side of the vertical position (Fig. 333). Other heads have a 90° graduation corresponding with the zero mark when the head is in the vertical position (Fig. 334).

In other words, the graduations are arranged to increase numerically from the zero in each direction in Fig. 333, and are arranged to decrease numerically from the 90° in each direction in Fig. 334. Both, however, will indicate an angular position through sixty degrees on each side of the vertical position. This, of course, must be taken into consideration whenever the head is swiveled in preparation for an angular cut.

As the head will be swiveled either to the right or to the left of the vertical position, the student must first determine the angle that the surface to be machined will make with a line vertical to the work and to the tool head when the head is in a vertical position. This angle can be easily determined if the angular construction of the triangle and the simple principle of opposite, corresponding, and complementary angles are understood.

1. The sum of three angles in a triangle always equals 180° or two 90° angles (Fig. 335). Therefore, if two angles are known, the third can be found.
2. In a right-angle triangle one of the angles is equal to 90° (Fig. 336). If one other angle is known, the third angle is easily determined.
3. The two angles contained in a right (90°) angle

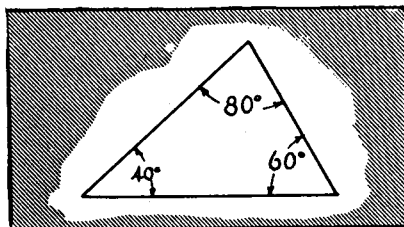

FIG. 335

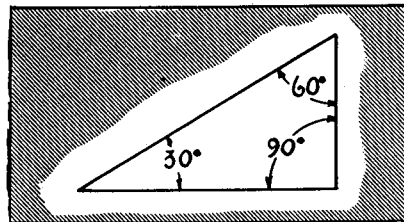

FIG. 336

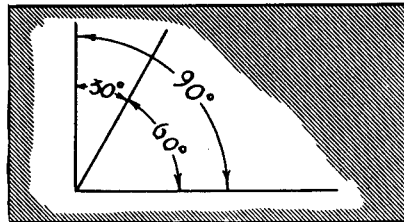

FIG. 337

are called complementary angles. Each is called the complement of the other (Fig. 337).

4. When two straight lines intersect, the opposite angles formed by the intersecting lines are equal. The angles marked X and the angles marked O are equal (Fig. 338).
5. When two straight parallel lines are intersected by a single straight line, the corresponding angles formed by the intersecting line and the parallel lines are equal (Fig. 339). The angles X are all equal and the angles O are all equal. The upper four angles correspond with the lower four angles.

These principles should be properly understood because they are essential for the proper understanding of angular problems.

A few examples will show the method of finding the angle at which the head must be set.

The job shown in Fig. 340 has a 90° opening. If a line A, Fig. 341, is imagined or drawn perpendicular to the work, the 90° angle will be divided into two 45° angles. This, then, is the angle at which the head must be set when the surface B is being machined. In this particular case, it is unimportant whether or not the head starts with a zero graduation (Fig. 333) or a 90° graduation (Fig. 334). As 45° is halfway between 0° and 90° , the head may be set first at 45° to the right of the vertical position; then, to finish the opposite surface, the work may be reversed in the vise or the head may be set 45° to the left of the vertical position.

The second illustration (Fig. 344) has an angular cut at 30° to the vertical. No calculations are necessary in this example because the angle indicated is the angle to which the head must be swiveled from the vertical position. Care should be observed, however, because of the two methods of graduating the head.

The rule is as follows:

1. When the graduations start with a zero opposite the zero mark on the ram and the head is in a vertical position, the angle is set "direct,"

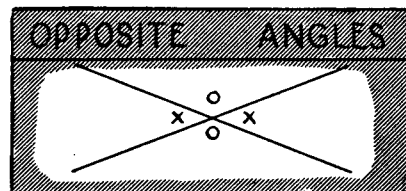

FIG. 338

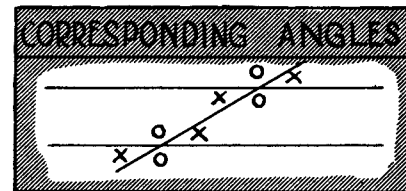

FIG. 339

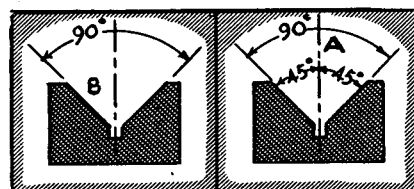

FIG. 340

FIG. 341

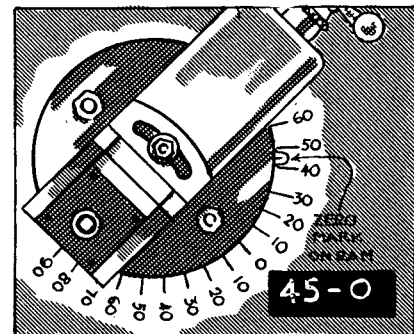

FIG. 342

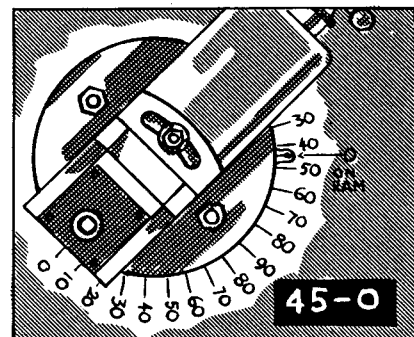

FIG. 343

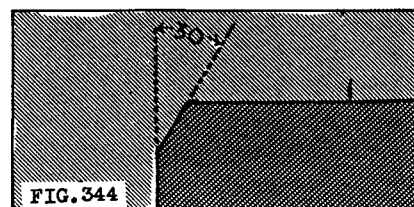
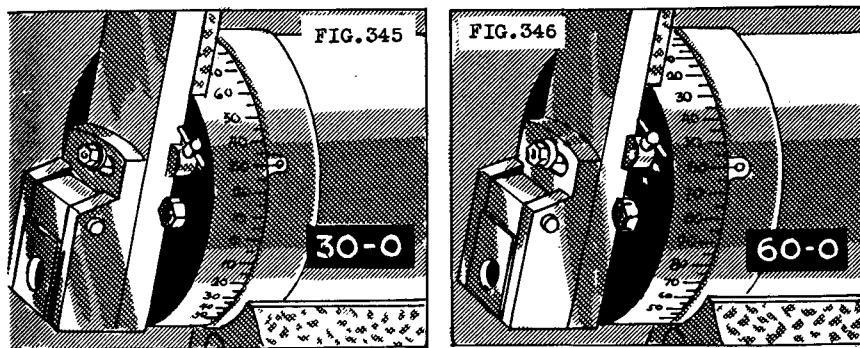

FIG. 344



which would be 30° (Fig. 345). "Direct" means that the graduations will be set at the same angle that the angular surface of the work makes with a vertical line.

2. When the graduations start with a 90° graduation opposite

the zero mark on the ram, the head must be set at the complement of 30° which is 60° (Fig. 346). Refer to page 228 for the definition of complementary angles.

If the angle is designated as in Fig. 347 and a line A is drawn vertical with the piece to form a 90° angle with the base of the work, the remaining angle is 30° , or the complement of 60° . The head must be swiveled 30° to the right if the graduations start with zero (Fig. 345). If the head is graduated as in Fig. 346, the head will be moved through 30° , but 60° will correspond with the zero mark on the ram.

In Fig. 348 the angle is indicated in a slightly different manner. The angle at which the head must be set can be found by forming a right triangle (Fig. 349). The triangle would then contain a 90° angle and a 40° angle. The third angle, then, must be 50° because a triangle contains 180° , or two 90° angles. (Refer to page 228 for definition.) A second method may be used to find the setting angle. If the lines in Fig. 350 are extended to A, B, C, and D, the principle of corresponding angles can be used. The lower 40° angle is corresponding and equal to the given or upper 40° angle. Since 50° is the complement of 40° , the head must be swiveled through 50° to cut an angular surface as shown in Fig. 348. The head is set at 50° if the graduations are arranged as in Fig. 351, and it is set at the complement, or 40° , if the graduations are arranged as in Fig. 352.

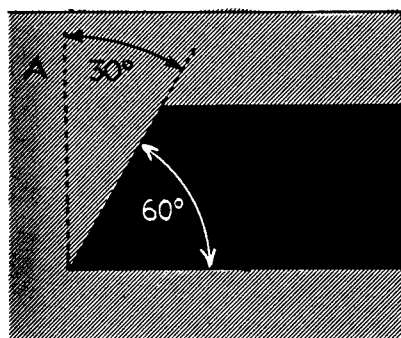

FIG. 347

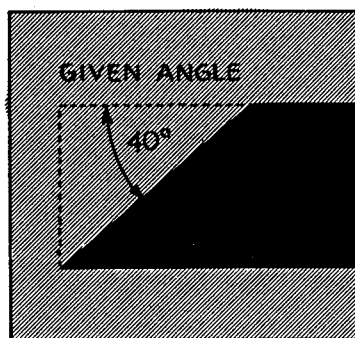

FIG. 348

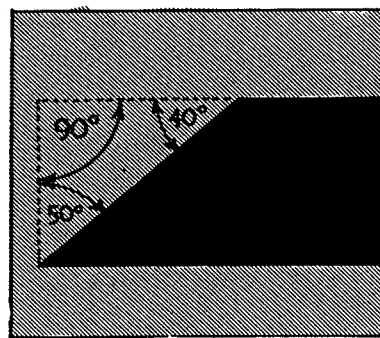

FIG. 349

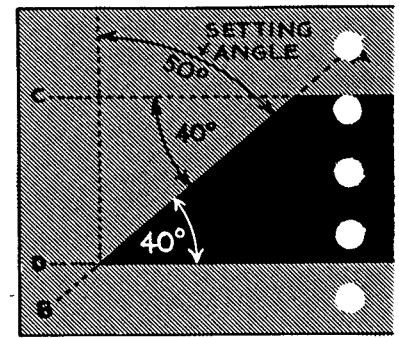
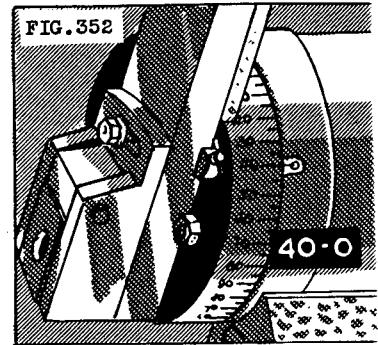
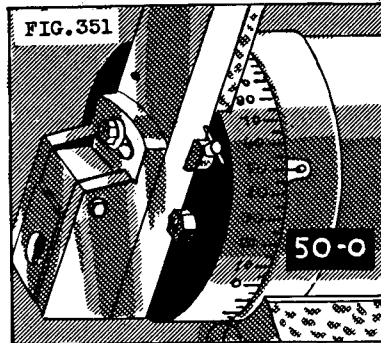

FIG. 350

Sometimes the angle may be given as illustrated in Fig. 353. A triangle may be formed by drawing a perpendicular line AA (Fig. 354). As the 130° angle contains a 90° angle, the other angle must be 40° ($130^\circ - 90^\circ = 40^\circ$). Hence, the triangle A B C (Fig. 355) now contains a 90° angle and a 40° angle; the third angle, therefore, must be 50° . The angle, then, to which the head must be swiveled from the vertical position to make an angular cut of 130° (Fig. 353) is 40° . If the head is graduated as in Fig. 346, the reading will be 50° , or the complement of 40° . Other methods may be used to compute the angle at which to set the tool head, but usually the following principles are sufficient for most cases.



SUMMARY

The following procedures should be followed to find the angle at which the head must be swiveled:

1. Determine the angle to which the tool head must be swiveled from the vertical position.
2. If the angle is not given directly, try to form a triangle or make use of the principle of opposite, corresponding, and complementary angles.
3. Swivel the head the desired number of degrees, starting from the vertical position. Read direct if the head is graduated as shown in Fig. 345. Set the head at the complement of the desired angle if the head is graduated as illustrated in Fig. 346.

There is another method of arranging the work in the machine which depends upon the angular setting of the vise to produce an angular

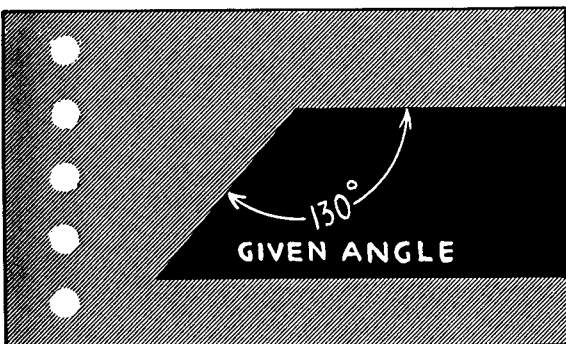

FIG. 353

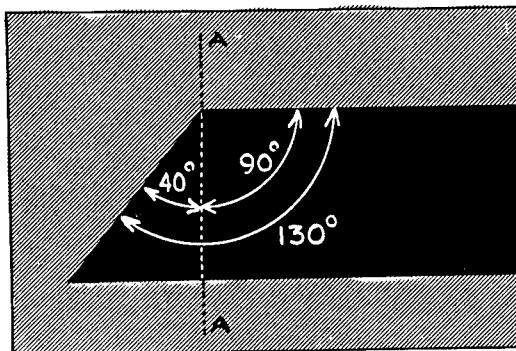

FIG. 354

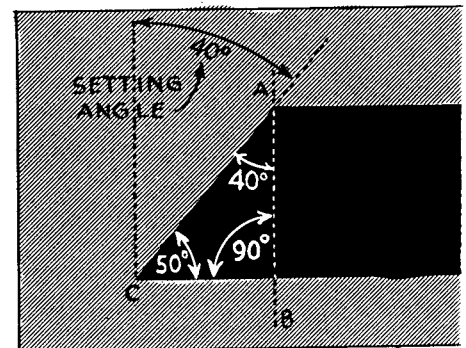

FIG. 355

surface. As this method is used to cut slots at an angle to the side of the work and to cut shallow grooves such as are required on a serrated surface, the method will be described in Unit 1-T53(C). This unit parallels the one in which the procedure is given for cutting slots and serrating.

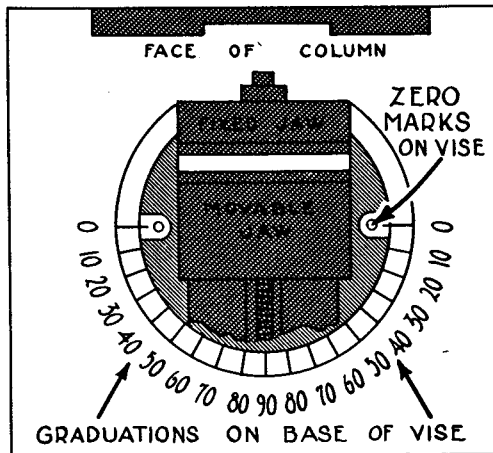

FIG. 356

The graduations on the base of the vise are arranged as in Fig. 356 so that when the jaws are set parallel with the column of the shaper, the two zero marks on the vise coincide with the two zero graduations on the base. This may be used as a starting position from which the vise may be swung either to the left or to the right for angular cutting. The angle at which the vise must be set depends upon the angular relation of the cut to that of the stroke, or, in other words, the angle that the cut makes with the direction of the stroke is the angle at which the vise is set.

For example, the job represented in Fig. 357 has an angular cut at 30° as shown. Assume that the work is in the vise in the position shown and the vise at the zero position (Fig. 356). By swiveling the vise 30° to the left as illustrated in Fig. 357, the work then will be in a position for the tool to take an angular cut of 30° as indicated.

One may not always be certain that the angle that the cut makes with the direction of the stroke will be shown on the drawing; the angle may be indicated as 60° in the manner shown in Fig. 358. By referring to the definitions given on page 228 it becomes quite obvious that the cut makes an angle of 30° with the direction of

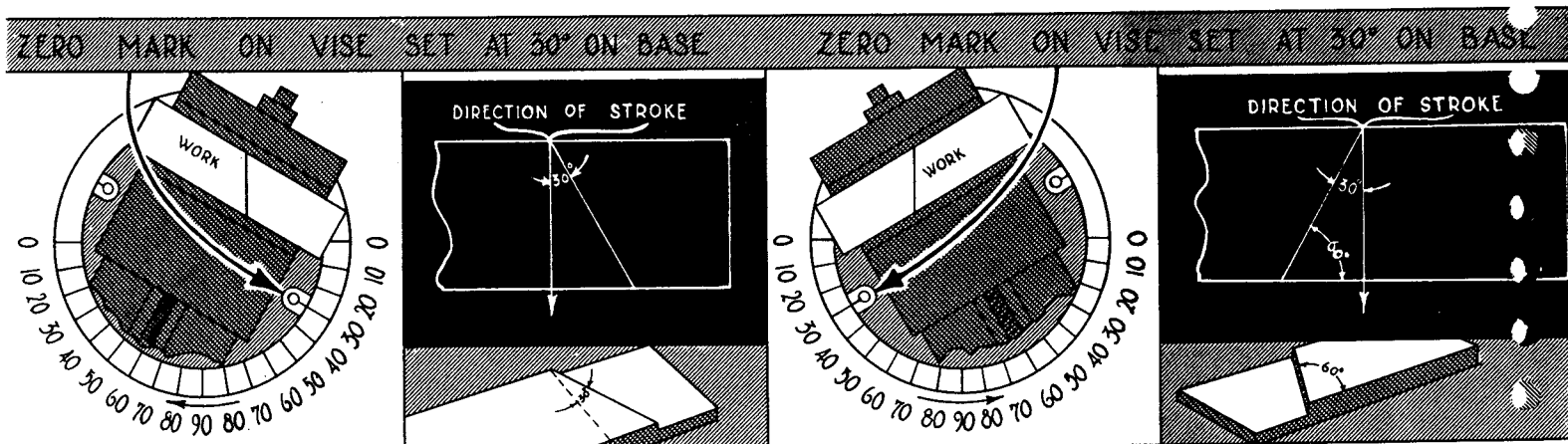

FIG. 357

FIG. 358

the stroke.

In the diagram (Fig. 358), if a line is drawn representing the direction of the stroke, it will form a right triangle, the edge of the cut being the second side, and the edge of the work being the base. Since the triangle now contains a 90° angle and a 60° angle, the third must be 30° .

$$(90^\circ + 60^\circ = 150^\circ \text{ and } 180^\circ - 150^\circ = 30^\circ)$$

Similarly, as the three angles are equal to two right angles, the two angles, other than the right angle, must equal 90° . Therefore, $90^\circ - 60^\circ = 30^\circ$.

The vise then is swiveled 30° to the right. The following rule can be used to determine the direction in which to swivel the vise. Whenever the edge of the cut slopes from left to right from the vertical position (Fig. 357), the vise must be swiveled to the left. Oppositely, whenever the edge of the cut slopes from the right to the left of the vertical position (Fig. 358), the vise must be swiveled to the right.

Another method of indicating the angle of the cut is shown in Fig. 359. The given angle is 50° . If a line is imagined or drawn to represent the direction of the stroke, it makes an angle of 90° (a right angle) with the side of the work. By subtracting the given angle of 50° from 90° , the answer is 40° , the angle at which to set the vise. These angles are also called complementary angles because the two angles are equal to 90° . One is the complement of the other. If one is known, the other is determined by subtracting the value of the known angle from 90° .

One other example is given in Fig. 360. The given angle is 110° . If the same procedure is followed — that of imagining or drawing a line to represent the direction of the stroke — it can be readily seen that the line makes a 90° angle with the side of the work. Subtracting 90° from 110° leaves 20° , which is the angle the cut

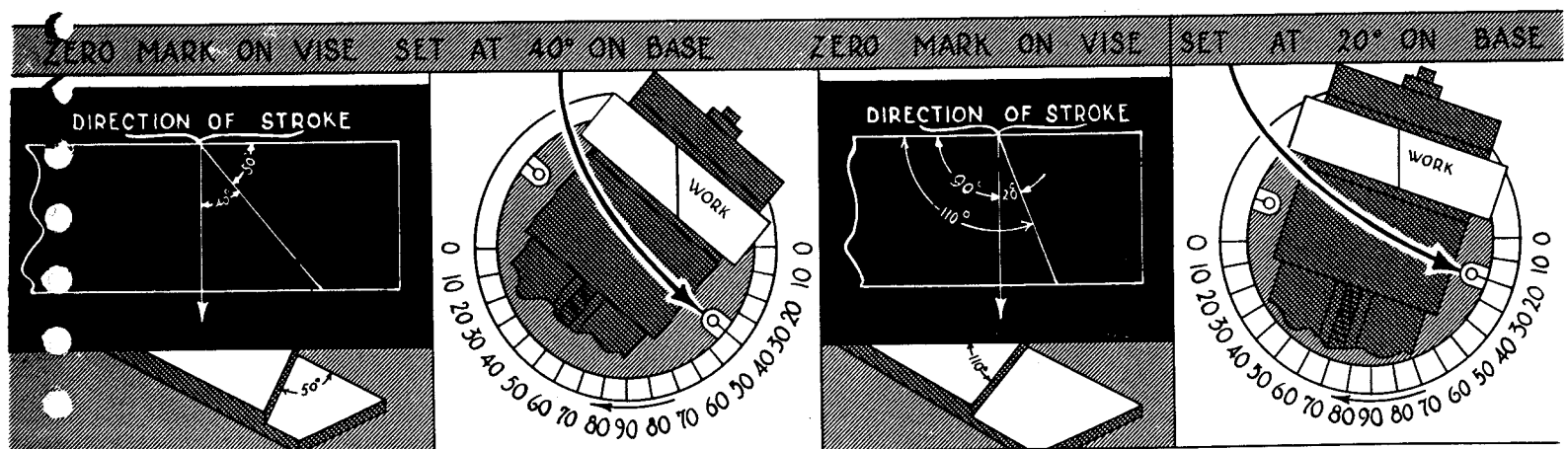

FIG. 359

FIG. 360

makes with the direction of the stroke and, therefore, is the angle at which to set the vise.

Two conditions, then, are encountered: either the angle that the cut makes with the stroke is given on the drawing and no calculations are necessary; or the angle that the cut makes with the sides of the work is shown and a few simple calculations must be made.

SUMMARY

When the angle given on the drawing (Fig. 357) is the angle that the cut makes with the direction of the stroke, the vise is set at the given angle.

When the angle given on the drawing (Figs. 358 to 360) is the angle that the cut makes with one of the sides of the work, one of the following procedures should be used:

1. Imagine or draw a line representing the direction of the stroke (Fig. 358). This will form a 90° triangle with the given angle as one of the angles in the triangle. Since the three angles of a triangle are equal to two 90° angles, the third angle is found by subtracting the given angle from 90° .
2. If the angle is given as in Fig. 359, subtract the given angle from 90° and the answer will be the angle at which to set the vise.
3. When the angle is given as in Fig. 360, subtract the 90° angle from the given angle. The answer is the required angle.

S E L E C T E D

R E F E R E N C E S

Burghardt, H. D.

Machine Tool Operation, Part II
McGraw-Hill Book Co.

Colvin & Stanley

American Machinists' Handbook
McGraw-Hill Book Co.

Oberg & Jones

Machinery's Handbook
Industrial Press



HOW TO PLANE ANGULAR SURFACES

Unit 1-P53(B) Parts I, II, and III Pages 235 to 258

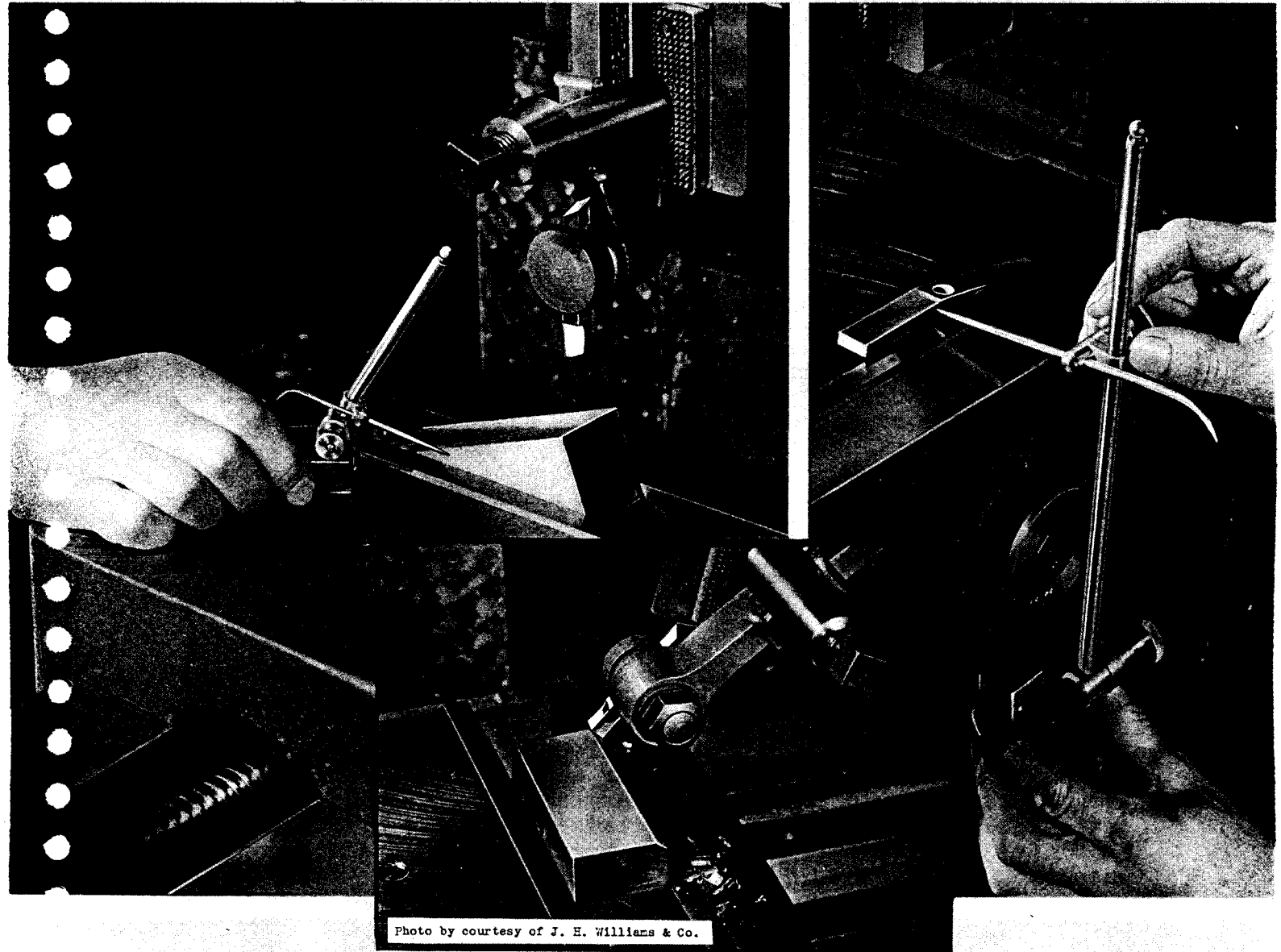

Photo by courtesy of J. E. Williams & Co.

UNIVERSITY OF THE STATE OF NEW YORK
STATE EDUCATION DEPARTMENT
BUREAU OF INDUSTRIAL AND TECHNICAL EDUCATION

OBJECTIVES OF UNIT

1. To show how to plane an angular surface when the work is held in a position at which a horizontal or vertical cut will form an angle with an adjacent surface.
2. To show how to form an angular cut when the cutting edge of the tool is set at an angle to the vertical or horizontal position.
3. To show how to cut an angular surface when the tool head is swiveled either to the left or to the right of the vertical position.

INTRODUCTORY INFORMATION

Three methods of producing angular surfaces are explained in this unit: (1) the work is set to produce the angle; (2) the tool is set to form the angle; and (3) the tool head is swiveled and the tool guided in an angular direction.

Regardless of the method employed, the work is laid out previously to being set in the machine. The accuracy of the setting is tested after the cut has been made by observing whether the surface has been machined to the layout or guide line, by checking the sizes with a scale, or by testing the angular surface with a protractor which has been set at the correct angle.

Whenever duplicate parts are made in quantity, a gage may be made and used to test the angular surfaces. The use of a gage will, in some cases, save time spent in laying out the work, frequently eliminate errors in angular calculations, and, in general, insure uniformity of product. When greater accuracy is required for checking the angular surfaces, other tools and methods are used. Since these methods require a knowledge of simple trigonometrical functions, the topic is left for a more advanced treatise on the subject.

TOOLS AND EQUIPMENT

Shaper		Pad and Pencil
Clean Cloth	Universal Protractor	Surface Gage
Steel Scale	Bevel Protractor	Cleaning Brush
Indicator	Taper Parallels	Fine-cut File
Oil Stone	Degree Parallels	Magnifying Glass
Tool Bits	Parallel Blocks	Coolant and Brush
Soft Mallet	Strips of Tissue Paper	Necessary Wrenches
Tool Holders	Heavy Paper or Cardboard	Necessary Blueprints

HOW TO PLANE ANGULAR SURFACES *when Work is set with the Surface Gage —*

PROCEDURE

SETTING UP THE WORK TO A GUIDE LINE

1. If it is necessary to mount the vise on the table, follow the directions given on pages 119 to 121.
2. Set the vise at 90° to the direction of the stroke. The zero mark on the vise will coincide with the 0° graduation on the base (Fig. 361). Refer also to page 124.
3. Clean the vise thoroughly, first with a brush and then with a clean cloth.
4. Remove any burrs from the vise jaws with a fine file. Usually a file will remove the burrs unless the jaws are extremely hard; then an oil stone may be used. Extremely hard jaws often chip instead of forming burrs.
5. Place pieces of paper or strips of cardboard between the vise jaws and the sides of the work if the work surfaces are rough or if there is any danger of injury to the vise jaws or the work (Fig. 361). Even if the sides of the work are smooth, the vise jaws may be in poor condition and injure the sides of the work when the vise is tightened. The vise jaws should be in good condition and every means should be used to keep them so.
6. Place the work in the vise and hold it with one hand so that the scribed guide line lies approximately parallel with the top of the vise (Fig. 361). Refer also to page 209.
7. Tighten the vise enough to hold the work in position, but loose enough to allow the work to be adjusted.
8. Support the work temporarily if the work is heavy until the jaws grip the work sufficiently to hold it in place.
9. Use the machined surface on the top of the movable jaw to support the surface gage, or use the shaper table as a leveling surface.

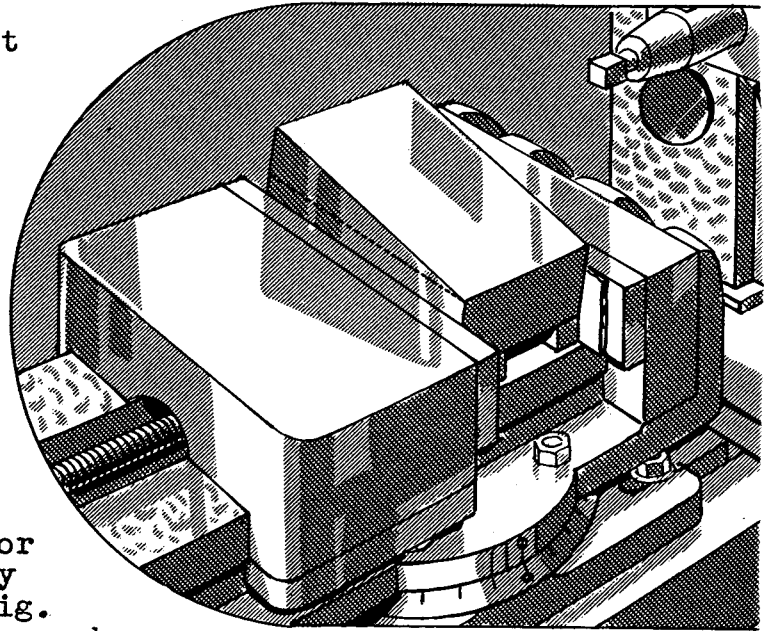

FIG. 361

NOTE: The single-screw vise usually has a planed surface on the top of the movable jaw which may be used as a surface to support the surface gage and to level the work in the vise (Fig. 362). If the vise has a double screw or, for any other reason, does not have a finished surface upon which to rest the surface gage, the table may be used as a leveling surface.

10. Clean the surface of the vise or table and the bottom of the surface gage with a clean cloth.

11. Wipe the palm of the hand over the surface of the vise or table and under the bottom of the surface gage to remove any small particles of grit.

CAUTION The palm of the hand acts like a soft pad when small particles of grit have to be removed. Care should be exercised, however, that no small steel cuttings are on the surface that is being cleaned with the hand, for they may get into the flesh and cause infection or injury.

12. Adjust the point of the surface-gage scriber to correspond with one end of the scribed line on the work (Fig. 362).

13. Move the scriber point to the other end of the scribed line, and at the same time raise one end or lower the other end of the work until the scriber corresponds at each end of the work exactly with the scribed line (Fig. 362). In other words, the surface gage is a means of setting the scribed line parallel with the surface of the table. It is a little more convenient, however, to use the top of the movable jaw to support the surface gage than it would be to have the base of the surface gage supported on the table.

14. Tighten the vise securely.

SETTING UP THE WORK ON TAPERED PARALLELS

NOTE: If there are a number of pieces to be machined at some specific angle, tapered parallels machined at the desired angle to hold the work may be used (Fig. 363).

1. Be sure that the vise, the work, and the parallels are clean.
2. Place the parallels in the vise and the work on the

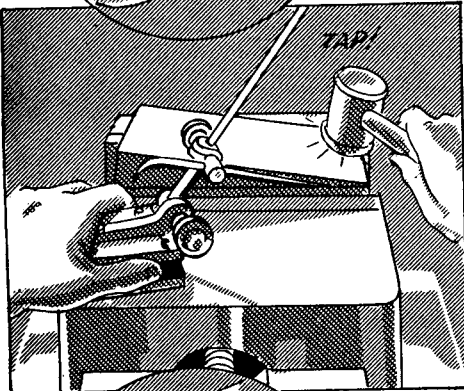
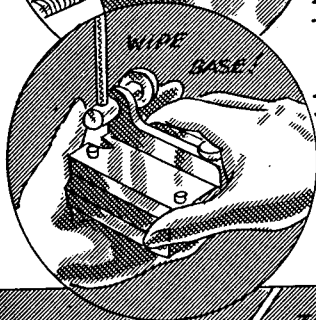
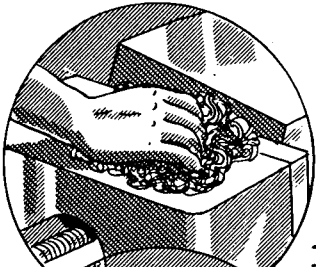

FIG. 362

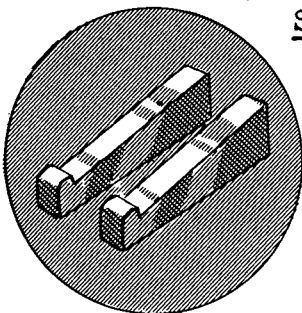
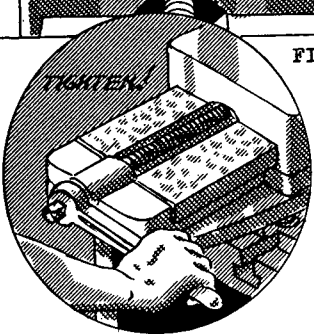

FIG. 363

parallels with protecting strips of heavy paper or cardboard between the jaws of the vise and the sides of the work (Fig. 364). Refer also to note on page 244.

5. Tighten the vise securely.
4. Tap the work down on the parallels with a soft mallet. The tap with the mallet must be heavy enough to seat the work on the parallels but not heavy enough to cause the work to rebound from the parallels.

NOTE: The parallels may be made without the shoulder (Fig. 365). The shoulder, however, prevents the parallels from slipping when the work is seated with a mallet.

SETTING UP THE WORK WITH DEGREE PARALLELS

1. Use the same precautions regarding cleanliness when the setup is being prepared as those given at the beginning of the unit.
2. Place the parallels in the vise and place the work between the parallels with projecting strips of paper between the vise and the parallels, and between the parallels and the work (Fig. 366).
3. Tighten the vise securely.
4. Tap the work down with a soft mallet.

SETTING THE TOOL (THE WORK SET TO A SCRIBED LINE)

1. Loosen the nut on the apron and move the clapper box to the right. This will allow the clapper box to swing the tool away from the work when it is feeding from the left to the right. Refer to page 170 for setting the clapper box.
2. Arrange the tool slide so that when the tool is moved down to the finished size there will not be more than one inch overhang of the tool slide (Fig. 368).
3. Measure with a scale (Fig. 369) the material to be removed.

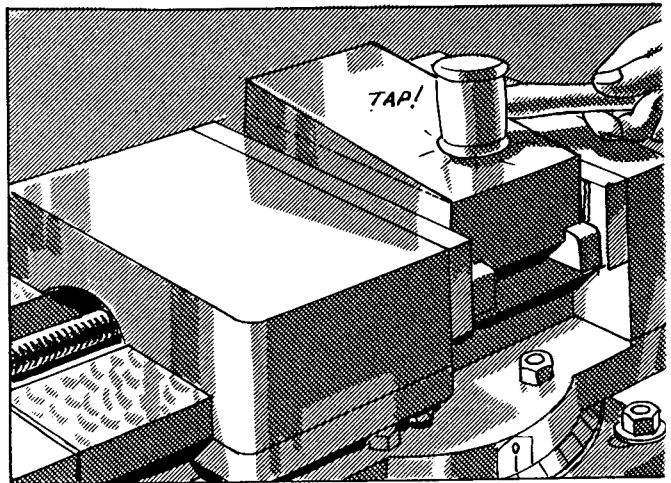

FIG. 364

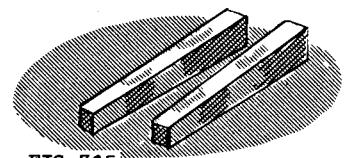

FIG. 365

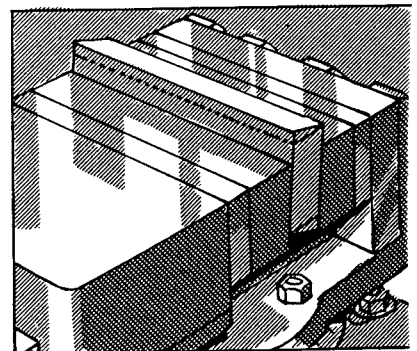

FIG. 366

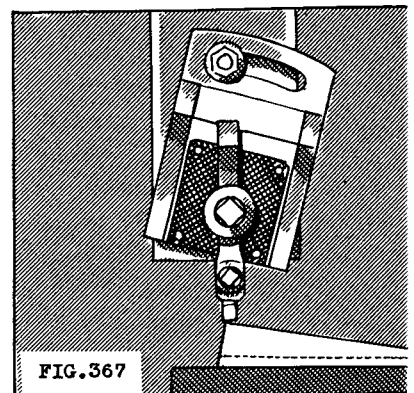
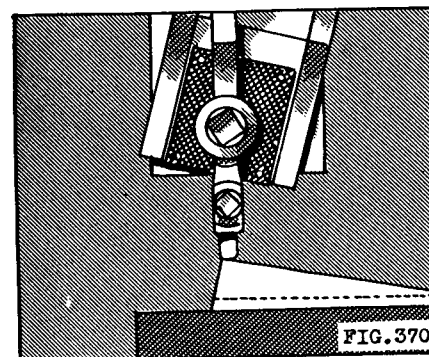
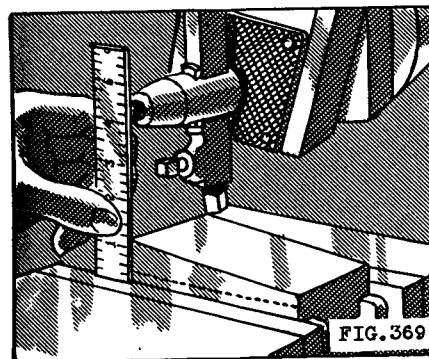
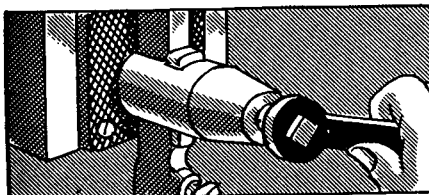
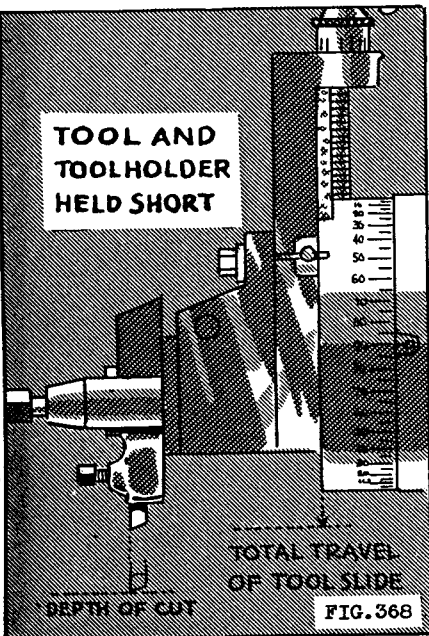

FIG. 367



4. Raise the tool slide above the bottom edge of the swivel block about one inch less than the measured depth of the material to be cut.
5. Select a tool holder from the available stock, preferably one that holds the tool parallel with the base and sides of the shank. (Refer to page 153.)
6. Select one tool illustrated on page 161, Fig. 228, to suit the tool holder, also taking into consideration the kind of material (cast iron, steel, etc.) and the direction of the feed (right to left, or left to right). Refer to page 157 for description of tools.
7. Set the tool holder in the tool post in a vertical position with as little overhang as possible (Fig. 368). (Refer to page 170.)
8. Tighten the tool-post screw securely. This will hold the tool holder securely in place.
9. Hold the tool short in the tool holder (Fig. 368) and tighten the tool-holder set screw to hold the tool in place.

HOW TO SET THE SHAPER PRIOR TO TAKING THE CUT

1. Move the table horizontally until the work is under the tool (Fig. 370). Refer to page 78 for adjusting the table horizontally.
2. Loosen the clamps on the cross rail and adjust the table vertically until the work just touches the tool (Fig. 370).
3. Tighten the clamps on the cross rail and adjust the table support. Refer to page 77 for adjusting the table vertically.
4. Adjust the ram for a stroke of about three-quarters of an inch longer than the length of the surface to be machined (Fig. 371). Refer to page 79 for adjusting the stroke.
5. Position, or adjust, the ram so that the tool will be about one-quarter of an inch beyond the work when it is at the extreme forward position (Fig. 371). Refer also to page 81 for positioning the ram.

6. Move the ram to the extreme end of the return stroke; there should be just enough clearance for the tool to drop clear of the work ready for the next cut (Fig. 371).
7. Set the speed of the ram for eighty strokes per minute, assuming that a roughing cut is to be taken on soft steel and that the length of the cut is six inches. (Refer to page 82 for setting the speed, and to page 299 for calculations.)
8. Set the feed for $1/32"$ (31 thousandths), using judgment as to whether or not the feed should be increased to $1/16"$ or more. (Refer to page 90 for setting the feed, and to page 304 for feed selections.)
9. Start the machine and move the tool down with the down-feed handle until the tool scrapes the high point of the work (Fig. 370).
10. Stop the machine and move the work to the left of the tool (Fig. 372).
11. Set the graduated dial on the down-feed screw at zero. Refer to page 65 for adjusting the dial.
12. Set the cut for $1/4"$, or 250 thousandths, on the graduated dial (Fig. 373). The depth of the cut may be increased, if necessary, consistent with the power of the machine and the rigidity of the work.

CAUTION The student may have the instructor check the setting of the work and the adjustment of the shaper before starting the cutting operation.

THE ROUGHING CUT

1. Start the machine and move the work over carefully until the tool scrapes the work (Fig. 374).
2. Engage the feed. Refer to page 59 for feed operation.
3. Observe the performance of the shaper and use judgment as to whether or not the feed and the depth of the cut can be increased.

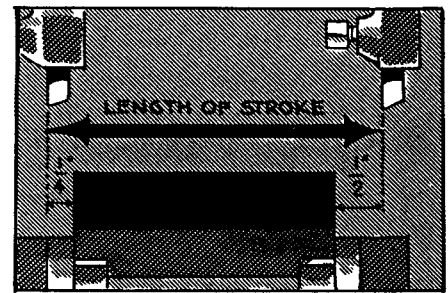

FIG. 371

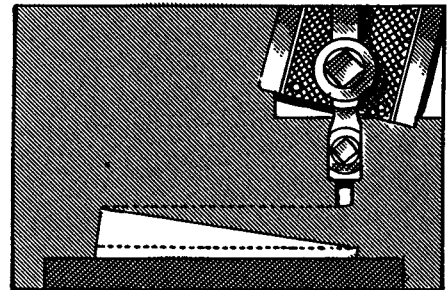

FIG. 372

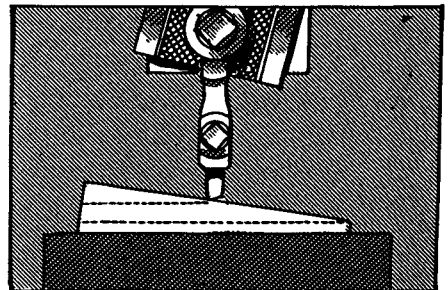

FIG. 373

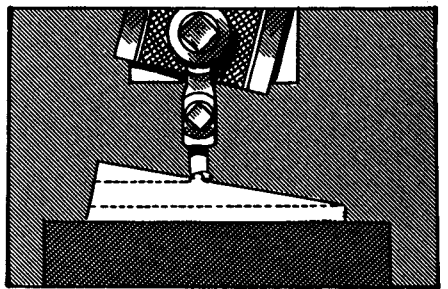

FIG. 374

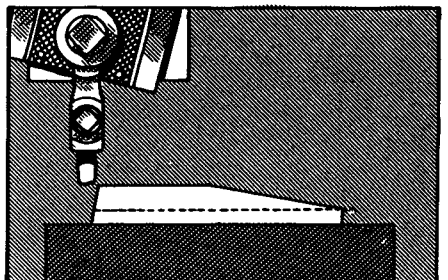

FIG. 375

These are roughing cuts and the purpose is to remove metal as quickly as possible.

4. Disengage the feed when the tool has finished the cut (Fig. 375).
5. Move the work again to the left of the tool, put on another cut, and engage the feed.
6. Continue to take a series of cuts, but be certain to leave from $1/32$ " to $1/16$ " of metal to be removed by the finish cut. The amount that should be left for finishing can be estimated after observing the condition of the surface left by the roughing cut. (Refer also to page 181.)
7. Stop the machine after the work has been roughed out.

THE FINISHING CUT

1. Remove the tool from the tool holder.
2. Regrind and stone the edge of the tool, or use the tool illustrated in Fig. 235, page 163.
3. Start the machine.
4. Move the work over with the cross-feed screw until the work is under the tool (Fig. 376).
5. Move the tool down with the down-feed handle until the tool scrapes the work (Fig. 377).
6. Move the work to the left and clear of the tool (Fig. 378).
7. Move the tool down the estimated depth of the finishing cut.
8. Feed the work carefully by hand with the cross-feed screw and allow the tool to cut far enough along the work to observe the full depth of the cut (Fig. 379). If the cut is too deep,

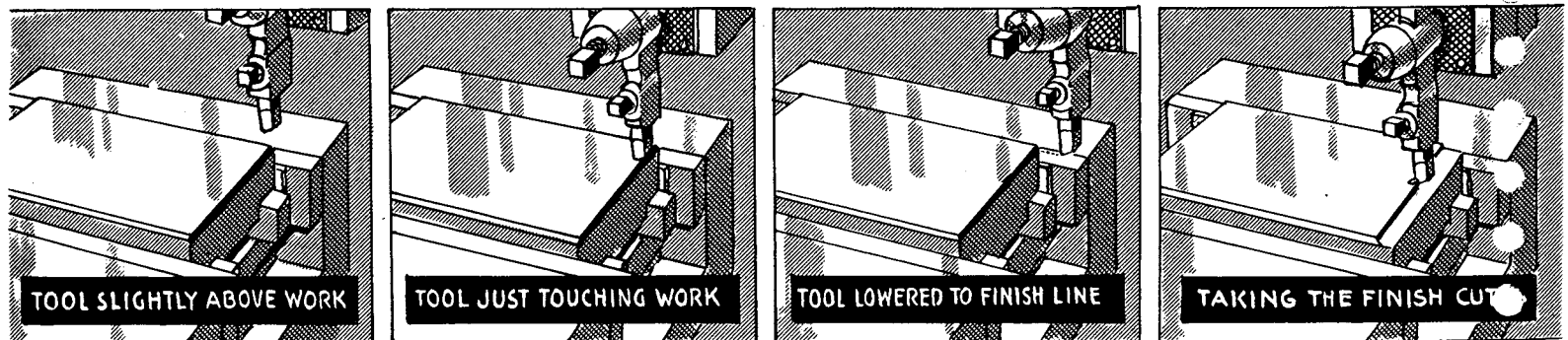

FIG. 376

FIG. 377

FIG. 378

FIG. 379

raise the tool slightly, take the back lash out of the screw, and try the cut again.

9. If the cut is not deep enough, increase its depth. When the setting is correct, engage the feed.
10. Place a little coolant on the surface, with a brush, to improve the finish.
11. Stop the feed and shut off the machine when the tool has finished the cut.
12. Remove the work from the vise, and remove the burrs with a fine or mill file.
13. Clean the vise and the table, and replace all tools in their proper places.

HOW TO CHAMFER A SURFACE *when Tool is set at an Angle -*

SETTING THE WORK IN THE VISE

1. If it is necessary to mount the vise on the table, follow the directions given on pages 119 to 121.
2. Set the vise parallel with the direction of the stroke. The zero mark on the vise will coincide with the 90° graduation on the base as pointed out on page 124. (Refer also to page 132.)
3. Clean the vise thoroughly, first with a brush and then with a clean cloth.
4. Examine the vise jaws for burrs. If burrs are present, remove them with a file if the jaws are soft, or with an oil stone if the jaws are hard.
5. Select two parallel blocks that will hold the work at the correct height in the vise. The work must be held as low as possible in the jaws to hold the work securely, but high enough to allow the tool to cut without interference.
6. Clean the parallels thoroughly and place them in the vise parallel with the jaws.

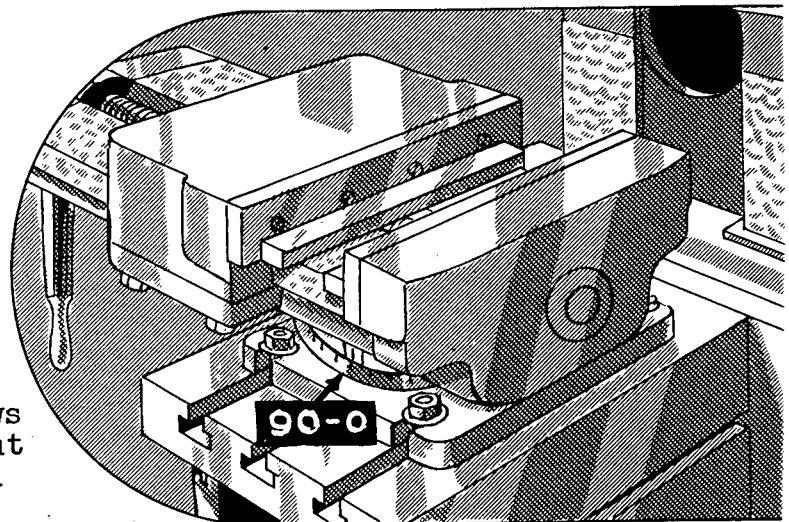

FIG. 380

NOTE: The finished surfaces of work, parallels, and vise jaws must be protected against injury caused by their coming into contact with rough or irregular surfaces. This is especially important when a vise is new and the jaws are true and the ground surfaces are undamaged. Castings and work with rough surfaces should have a protecting strip of cardboard or soft metal between the vise jaws and the work. If the surfaces of the work are finished, strips of heavy paper should be placed between the jaws of the vise and the work. Likewise, strips of cardboard should be placed on top of the parallels to protect them from rough and irregular surfaces. When the work has a finished surface, tissue paper may be placed between the top of the parallels and the work. These pieces can be used to test the work when it is being seated on the parallels. Frequently, however, no protecting strips or pieces of paper for testing are used between surfaces. The surfaces are cleaned thoroughly, clamped in the vise, and tapped down on the parallels. If the vise is old, the jaws in poor condition, and the machining requirements of the work not especially accurate, the immediately preceding practice of not using protecting strips may be justified. Judgment, however, must be used in all cases.

7. Put strips of tissue paper on the parallels and lay the work centrally in the vise and upon the parallels. This central position of the work will equalize the pressure against the jaws when they are tightened (Fig. 381).
8. Place strips of paper between the vise jaws and the sides of the work.
9. Hold the work down with one hand, and clamp the work securely in the vise.

CAUTION Regardless of the fact that the work is held down on the parallels with the hand, the work is usually raised slightly when the vise jaws are tightened. (Refer to note on page 192 for explanation.)

10. Tap the work down in the vise with a lead or rawhide mallet until the pieces of tissue paper are gripped between the bottom of the work and the top of the parallels (Fig. 382).

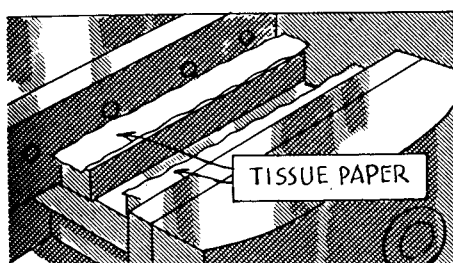

FIG. 381

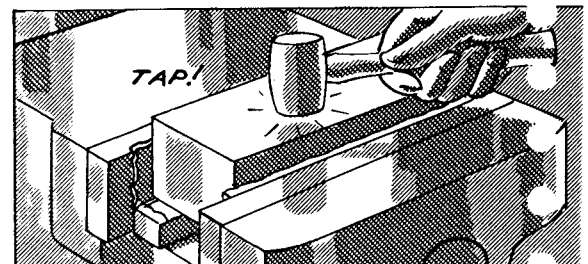
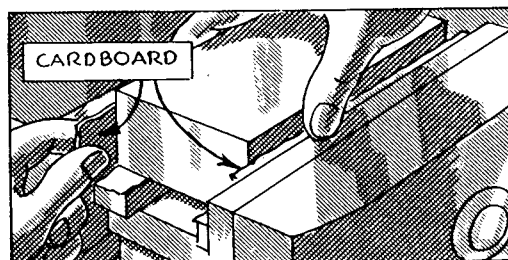

FIG. 382

CAUTION The tap with the mallet must be heavy enough to seat the work on the parallels, but not heavy enough to cause the work to rebound from the parallels.

SETTING A SQUARE-NOSED TOOL AND ADJUSTING THE SHAPER PRIOR TO OPERATING

1. If a square-nosed tool is used, select a tool holder that can be set with the cutting edge of the tool behind the point of support (Fig. 383). (Refer also to page 154.) If a tool that will cut on the side is employed, an ordinary holder may be used (Fig. 384).

CAUTION When a wide cut is being made and the tool is set ahead of the supporting point, tremendous pressure is built up during the cutting action on account of the downward spring of the tool. When a tool is set with the cutting edge behind the point of support, the tool swings away from the work, the pressure is released, and the cutting action is smoother. When, however, the tool is cutting on a side edge, the tendency of the tool is to spring sideways and, although the tool is set ahead of the point of support, there is not the same tendency to dig in as there would be in the former case (Fig. 383).

2. Adjust the bottom of the tool slide until it is even with the bottom of the swivel block (Fig. 385).
3. Hold the tool in the tool holder so that the cutting edge of the tool will be held behind the point of support (Fig. 385).
4. Have the tool project about 1/2" to 3/4" beyond the tool holder, or, in other words, "hold the tool short." Tighten the tool in the tool holder with the fingers.
5. Place the tool holder in the tool post in a vertical position and have it project below the clapper box about 2-3/4" or less, if the tool does not interfere.

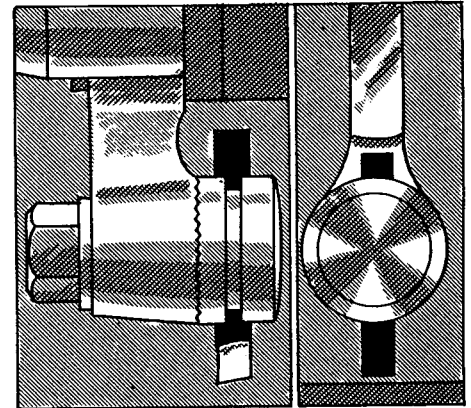

FIG. 383

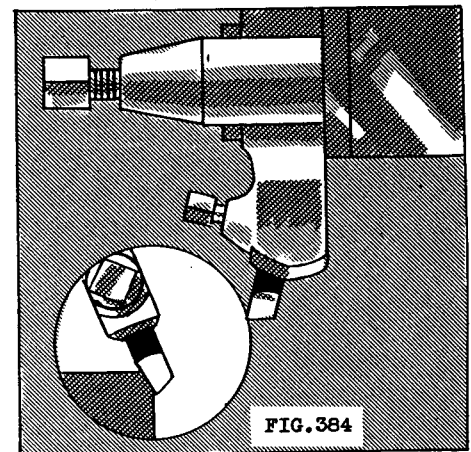

FIG. 384

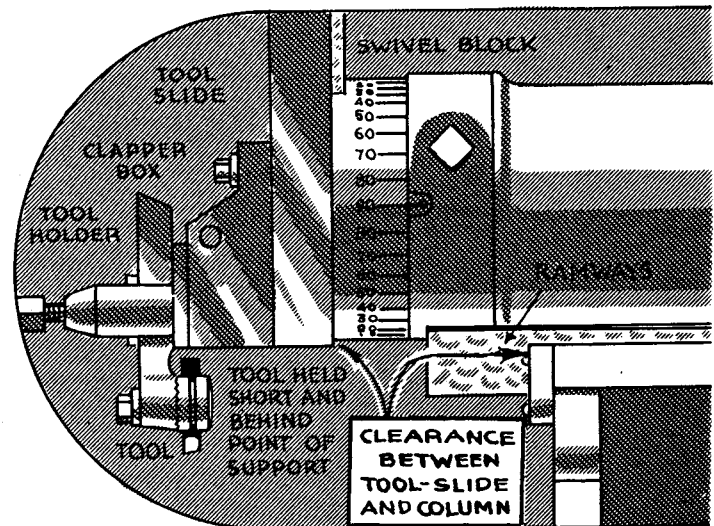

FIG. 385

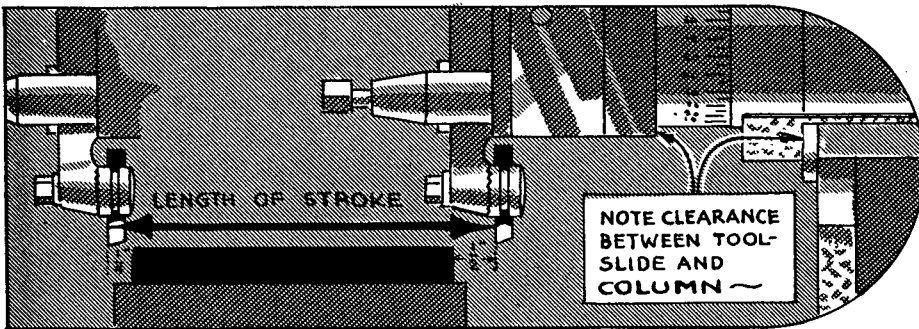

FIG. 386

6. Tighten the tool holder in the tool post.
7. Tighten the tool in the tool holder after the tool holder has been clamped securely in the tool post. If the tool holder has been clamped first in the tool post, the tool holder will be rigidly held when the tool is being tightened.

8. Set the stroke of the shaper $3/4$ " to 1" longer than the length of the surface to be machined (Fig. 386). (Refer to page 79.)
9. Position the ram so that the tool is about $1/4$ " beyond the work when it is at the forward position (Fig. 386). (Refer also to page 81.)

NOTE: The setting of the tool for angular cutting will depend upon the accuracy of the angular surface. When an angular cut is made by this method it is usually approximate. The tool is set to break, or chamfer, the edge as a safety feature, or the cut may be made to improve the appearance or to provide clearance. If the corner of the work has been laid out, the tool may be set to the scribed line. The head may be set vertically or swiveled at an angle of 90° to the angular surface to be machined. In this setup the tool head will be swiveled.

10. Move the ram to the beginning of the stroke and notice whether or not the head will strike the column when the head is swiveled (Fig. 386).

CAUTION

The shaper is designed so that the tool head will pass between the two ram ways when the head is in the vertical position. When the head is swiveled, however, care must be observed that the tool head does not strike the column on the return stroke.

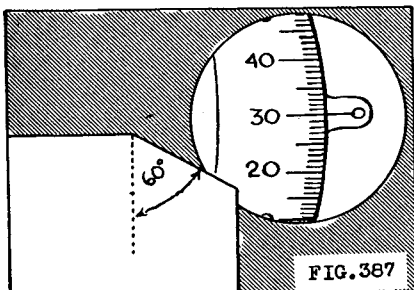

11. Swivel the tool head, for example, 30° to the right of the vertical position, assuming that the angle to be cut is indicated as 60° (Figs. 387 and 390). (Refer to page 228 for calculations and to page 91 for setting the tool head.)

NOTE: The head is swiveled to this position because it provides a better direction in which to feed the tool. The accuracy of

the angular cut will depend upon the correct alignment of the cutting edge of the tool with the scribed line on the work or with the blade of a protractor.

12. Move the ram and the tool to the forward position.
13. Move the table until the work is under the tool (Fig. 388).
14. Loosen the cross rail and raise the table if there is too much space between the bottom of the tool and the top of the work. Be sure that the cross rail is clamped and the table is properly supported after the height of the table has been adjusted (Fig. 389). (Refer also to page 77, How to Adjust the Cross Rail.)

NOTE: If the space between the bottom of the tool and the top of the work is excessive and the tool slide is moved down instead of the table being raised, the tool slide will overhang too much.

15. Stand in front of the work and the tool, and place the head in such a position that the cutting edge of the tool is in the same line of vision with the scribed line on the surface of the work.
16. Adjust the tool holder by loosening the tool-post screw slightly and tapping the tool holder to the right or to the left until the cutting edge of the tool is parallel with the scribed line on the work (Fig. 389).
17. Tighten the tool holder securely when the tool has been adjusted correctly.

NOTE: An alternate method of setting the tool to the correct angle is to use a protractor or gage (Fig. 391). The protractor is set at the angle A, which must be determined from the angle given on the drawing, or blueprint. (Refer to page 228 for angular calculations.) The tool holder is then adjusted until the edge of the tool and the blade of the protractor are parallel.

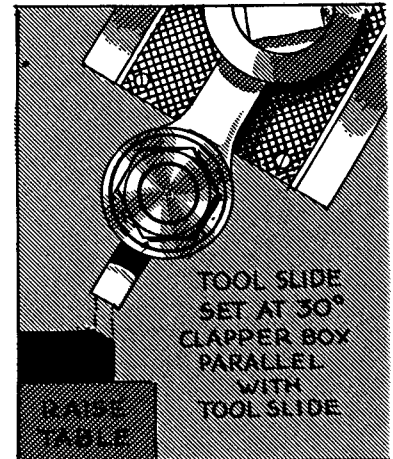

FIG. 388

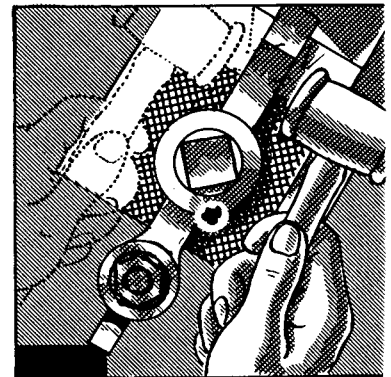

FIG. 389

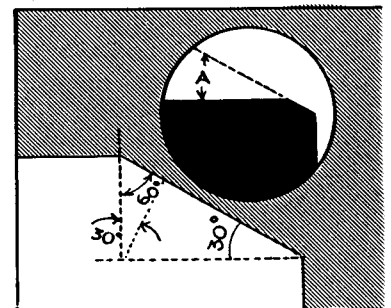

FIG. 390

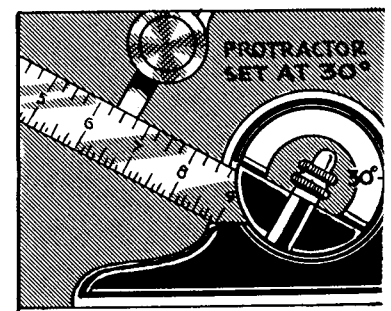

FIG. 391

TAKING THE CUT

1. Engage the back gears and set the machine for a slow speed. (Refer to page 82.)

CAUTION Standard speeds do not apply to broad cuts, and no definite rules are given. The speeds are usually much slower than ordinary cutting speeds and are taken with the back gears engaged because considerable power is required and the speed is reduced to eliminate chatter. Start with a slow speed and increase the speed carefully in accordance with the finish and the type of cut desired.

2. Adjust the work and the table with the cross-feed hand crank until the tool is directly opposite the edge to be cut (Fig. 392).

3. Move the tool toward the work with the down-feed crank until the cutting edge of the tool is near the edge of the work (Fig. 393).

CAUTION Be sure that there is nothing in the path of the tool, and that the speed is correctly set, that the work is securely held, and that all necessary clamps are tightened. This is a good point at which to have the setup checked by the instructor.

4. Start the machine and move the tool with the down-feed crank until the tool takes a light cut (Fig. 394).

5. Apply a little coolant to the surface with a brush. This will help preserve the cutting edge of the tool and will produce a smooth, bright surface (Fig. 395). Cast iron is machined dry.

6. Move the tool down about fifteen thousandths or more when the tool is at the beginning of the stroke and while the machine is in motion. As the cut gets wider, the amount of feed will be gradually decreased.

7. Continue feeding the tool toward the surface until the required width of the cut has been attained.

8. Stop the machine.

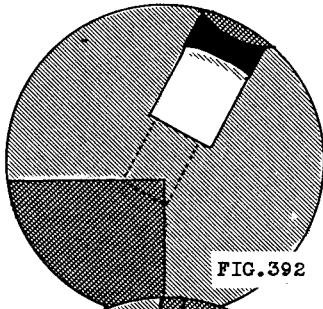

FIG. 392

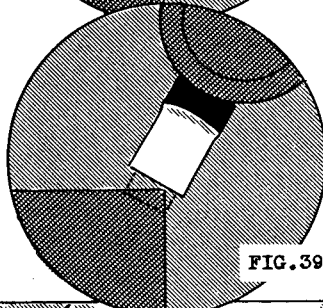

FIG. 393

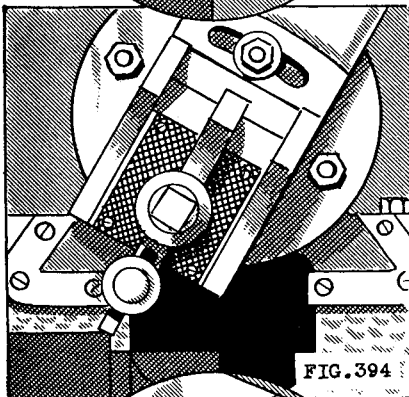
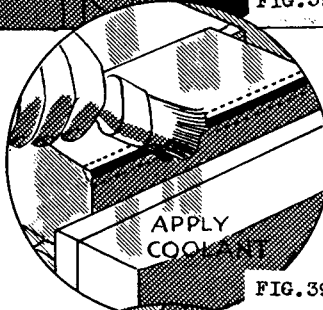

FIG. 394



APPLY
COOLANT

FIG. 395

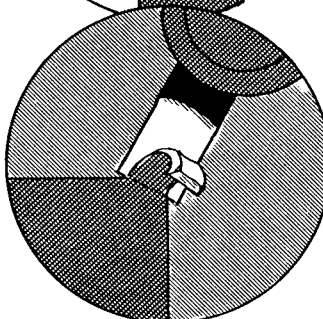

FIG. 396

NOTE: If the work is made of cast iron, the tool will leave the forward edge of the work broken and rough. To avoid this, a slight bevel is filed on the corner of the work (Fig. 397). The filed or beveled edge has the effect of gradually diminishing the depth of the cut until no cutting action takes place on the extreme forward edge of the piece (Fig. 398).

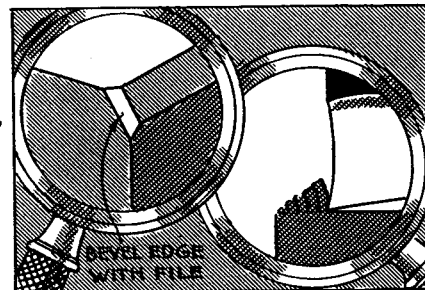

FIG. 397 FIG. 398

SETTING A SIDE-CUTTING TOOL

NOTE: If the angular surface forms a slight angle with the vertical, a side-cutting tool may be used (Fig. 400). For example, on the assumption that the surface makes a 15° angle with the vertical position, the head would be moved through 75° in order to feed the tool perpendicularly to the angular surface (Fig. 399). The head is graduated through only 60° for each side of the vertical position. Therefore, the following setup is more convenient.

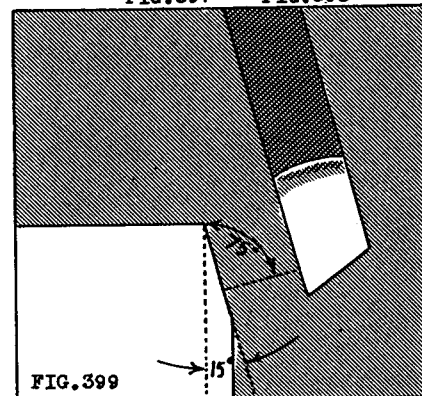

FIG. 399

1. Set the tool head in the vertical position (Fig. 400). (Refer also to page 91.)
2. Set the clapper box over to the right (Fig. 400). (Refer also to page 170.)
3. Place the tool holder in the tool post and tighten the tool-post screw securely.
4. Select the tool illustrated in Fig. 399 and on page 166.
5. Hold the tool short and tighten it securely in the tool holder (Fig. 400).
6. Adjust the length of the stroke so that it will be $3/4$ " longer than the length of the work. (Refer to page 79.)
7. Position the ram so that the cutting edge of the tool is about $1/4$ " beyond the work when the ram is at the forward position (Fig. 386). (Refer also to page 81.)

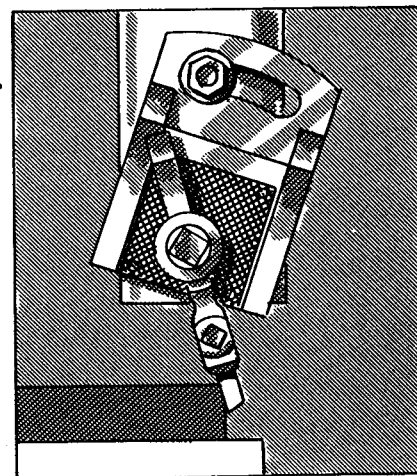

FIG. 400

NOTE: The tool will be set and moved into position by a series of adjustments. The table will probably have to be adjusted vertically and moved horizontally, and the tool holder set to the correct angle. The adjustments need not be made in any specific order, but should be continued until the tool is set in the desired position.

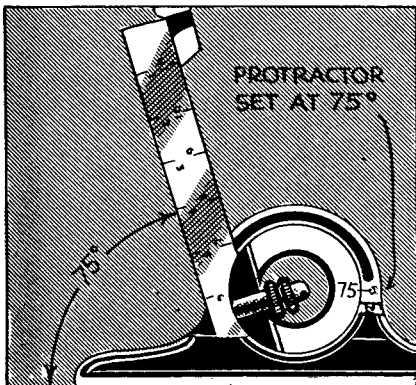

FIG. 401

8. Loosen the tool-post screw and move the tool holder until the cutting edge of the tool is approximately in line with the scribed line, or until the cutting edge coincides with the blade of the protractor set at 75° (Fig. 401). (Refer also to page 226 for angular measurements.)

NOTE: The tool may be moved vertically downward to the cut, the work may be moved horizontally to the tool, or a combination of both these movements may be used (Fig. 402). If the tool is set in position A, the tool must be moved vertically downward toward the work. If the tool is set in position B, the tool head may be locked and the work must be moved horizontally toward the tool. If the tool is set in position C, a combination of tool and work movements must be made to bring the tool and the work into their proper relation. For this setting, assume that the tool is to be set in position A.

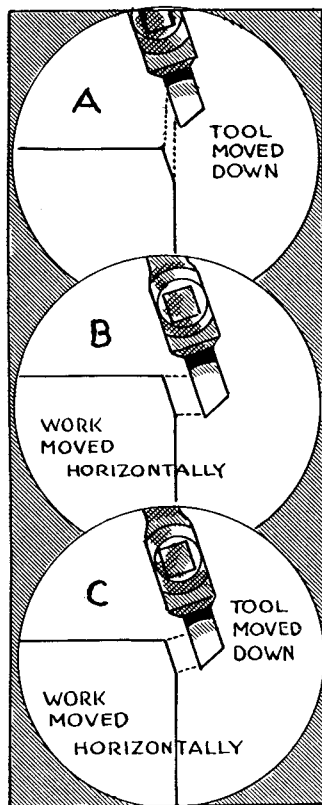

FIG. 402

9. Loosen the rail clamp and adjust the table vertically up or down. Tighten the rail clamp when the adjustment has been made. (Refer to page 77 for adjusting the table vertically.)
10. Move the table horizontally if it is necessary to bring the work horizontally nearer to the cutting edge.
11. Check the position of the tool and be sure that the tool head does not overhang too much when the cut has been completed.
12. Engage the back gears and set the machine for a slow speed. (Refer also to the Caution on page 248.)

TAKING THE CUT

1. Start the machine and move the tool with the down-feed crank until it just scrapes the corner of the work (Fig. 403).
2. Apply a little coolant to the surface with a brush.
3. Move the tool down about fifteen thousandths while the machine is in motion and when the

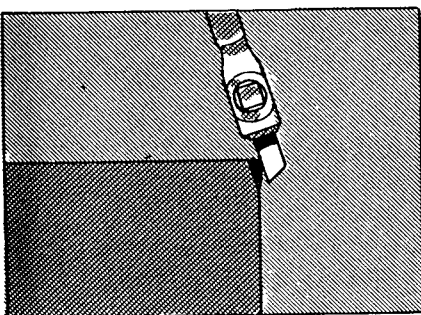
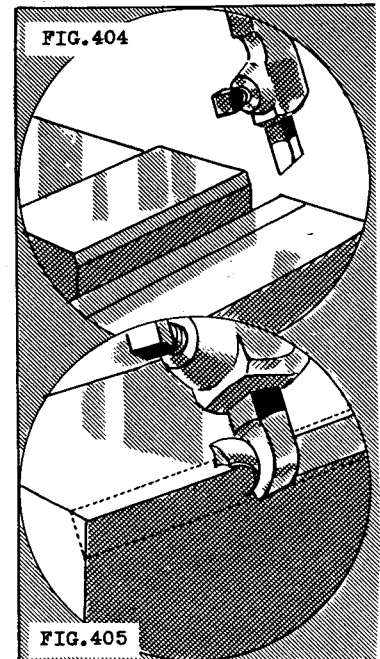

FIG. 403

tool is at the beginning of the stroke (Fig. 404).

4. Decrease the downward movement of the tool to only a few thousandths per cut as the machined surface increases in width. Keep the cut as heavy as possible, however, but when the tool is within $1/32$ " of the finish line, reduce the feed to a few thousandths per stroke.
5. Continue moving the tool downward until the width of the surface is correct.
6. Stop the machine, take the work from the vise, and remove the burrs from the work with a mill file.
7. Remove the tool from the machine, clean all the tools, and put them in their proper places.
8. Clean the vise and the shaper table.



HOW TO PLANE AN ANGULAR SURFACE *when Head is set at an Angle —*

MOUNTING THE WORK IN THE VISE ON PARALLELS

NOTE: The degree of accuracy required in both the size and shape of the finished work influences the selection of the procedure to be used when the work is being machined. One of three procedures may be used to make certain that the top surface of the work is parallel in the vise: (1) after the work has been leveled on the parallels, a cut may be taken across the top surface of the work; (2) the work may be finished on the top, bottom, and sides and then properly seated on the parallels; (3) when greater accuracy is required, the top surface should be leveled with an indicator.

1. Set the work on parallels in the vise following instructions Nos. 1 to 10 on page 243.
2. If enough metal has been left on the top surface for a finishing cut, take a horizontal cut across the top of the work. If the top surface is finished, the proper seating of the work on the parallels will be sufficient.
3. If greater accuracy is required when the top surface of the work is being leveled in the vise, the surface may be leveled with an indicator (Fig. 406).

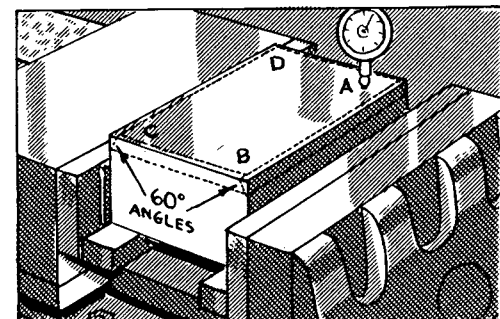

LEVELING THE WORK IN THE VISE WITH AN INDICATOR

NOTE: There is so much similarity between the procedure used to level the vise on the table and the procedure used to level the work in the vise with an indicator that if the word "work" is substituted for the word "parallels," many of the instructions used in the former section, How to Set the Bottom of the Vise Parallel with the Table with an Indicator, can be applied equally well to this section.

1. Attach the indicator to the tool holder. (Refer to instructions Nos. 9 to 14 on page 127.)
2. Adjust the length of the stroke and position the ram so that the point of the indicator travels within 1/2" of each end of the work. (Refer to Nos. 16 and 17 on page 128.)
3. Lower the indicator until the pointer registers about ten one-thousandths of an inch on the dial. This will indicate that the point is making contact with the work.
4. Indicate the work at all four points: A, B, C, and D (Fig.406).

NOTE: As the work has been leveled in the vise on parallels and has been set down tight on the parallels in the previous setting, a shim must be placed underneath the low spot if it is necessary to raise the work at any point.

5. Obtain a shim equal in thickness to the error shown on the dial. Use a micrometer to measure the thickness of the shim.
6. Raise the indicator until the contact point is about 1/2" above the work.
7. Loosen the vise jaws and place the shim underneath the low part of the work and on the top of the parallel block.
8. Tighten the vise jaws and tap the work down with a soft mallet until all paper shims are tight between the work and the parallels.

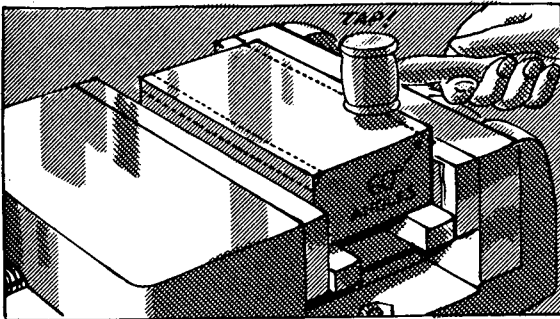

FIG. 407

9. Test again the work surface at all four points and repeat the shimming and testing process until all points are level.
10. Remove the indicator from the tool holder, and place the indicator in the box.

SETTING THE TOOL HEAD

1. Adjust the stroke of the machine for about $\frac{3}{4}$ " to 1" longer than the length of the surface to be cut. For adjusting the stroke on the crank shaper, refer to How to Adjust the Stroke on pages 79 and 80; for the hydraulic shaper, refer to How to Adjust the Stroke and Position the Ram on pages 92 and 93.
2. Move the ram back until it is at the beginning of the stroke and observe whether or not the tool head will strike the ram ways when it is swiveled at an angle (Fig. 408).

CAUTION If there is not enough clearance to permit swiveling the head without striking the ram ways, position the ram, or move it forward, until the tool head can be swiveled and there is clearance between the head and the ways. This is an important adjustment, for if the tool head were to strike the ram ways on the return stroke, the head would be broken or damaged severely.

3. Assume that an angular cut of 60° , as indicated in Fig. 409, must be made.
4. Determine the angle to which the tool head must be swiveled from the vertical position. This angle is 30° , or the complement of 60° . (Refer to page 228 for the definition of complementary angles.)

NOTE: The operator should observe which of the two methods, described on page 228, is used to graduate the tool head.

5. Loosen the head lock, and swivel the head to the right until the 30° graduation on the tool head coincides with the zero mark on the ram (Fig. 410). This will be the setting if the graduations start with a zero on the tool head when it is in a vertical position. (Refer to page 91, How to Adjust the Tool Head.)
6. Swivel the head to the right until the 60° graduation on the head coincides with the zero mark on the ram (Fig. 411). This will be the setting if the graduations start with 90° when it is in a vertical position.

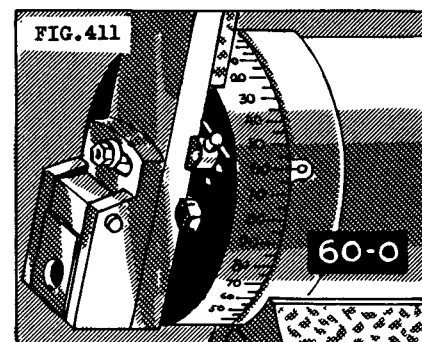
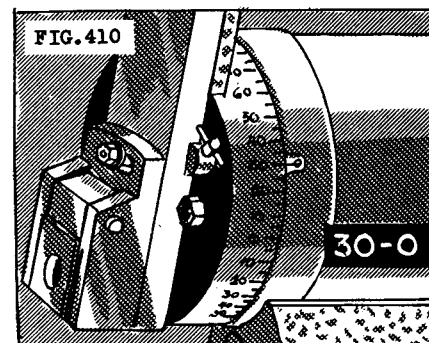
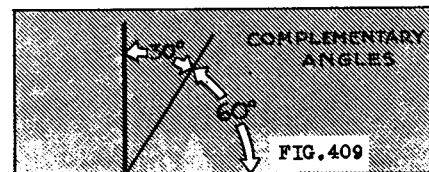
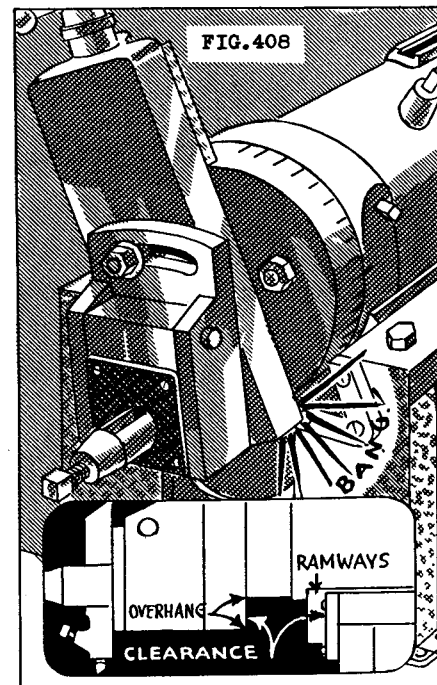

7. Use a magnifying glass to make certain that the zero mark on the ram coincides exactly with the graduation on the head. The glass magnifies any slight variation in the position of the matching lines, thereby making possible a more accurate adjustment of the markings.
8. Tighten the head lock securely after the tool head has been set in position.

NOTE: The head may be set with the aid of a protractor. The protractor is first set at the correct angle and then supported on the movable jaw of the vise, or on parallels supported on the table. The side of the tool slide is then set parallel with the edge of the protractor blade (Fig. 413). This method can be used also to check the angular setting of the head.

9. Set the clapper box over to the left as far as possible (Fig. 414). This will allow the tool to swing clear of the work on the return stroke. (Refer also to page 179.)

SETTING THE TOOL AND ADJUSTING THE SHAPER PRIOR TO OPERATION

1. Select a tool holder like the one illustrated in Fig. 209, page 155. This will hold the tool parallel (horizontal) with the shank of the tool holder, and will allow the tool to be set at a slight angle to the angular surface without interfering with the side of the tool holder (Fig. 414).
2. Place the tool holder in the tool post so that it makes an angle of about 5° to 10° with a line parallel with the side of the tool slide (Fig. 414).
3. Tighten securely the tool holder in the tool post.
4. Move the tool slide down until there is not more than 1" overhang (Fig. 408).
5. Select a tool similar to the one illustrated on page 162, Fig. 229, but ground to cut on the opposite side.
6. Estimate the distance that the tool must project beyond the holder to permit the tool holder to



FIG. 412



FIG. 413



FIG. 414

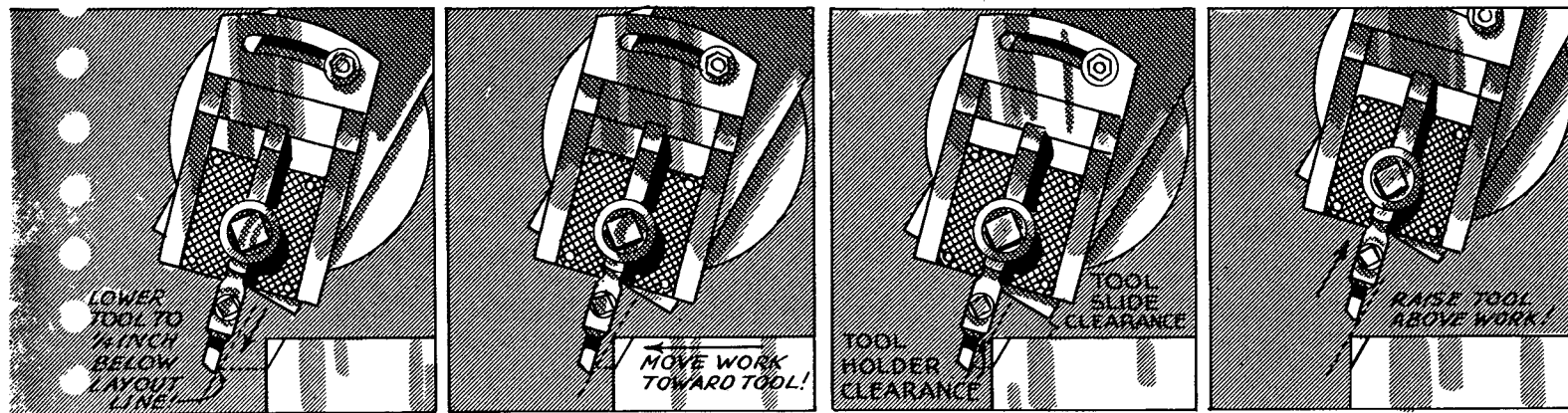

FIG. 415

FIG. 416

FIG. 417

FIG. 418

clear the surface being machined (Fig. 417).

7. Tighten the tool temporarily in position with the fingers because the final setting of the tool and the work is a combination of the following adjustments (Nos. 8 to 12).
8. Raise or lower the work and the table until the cutting edge of the tool is slightly lower than the bottom edge of the indicated angular cut (Fig. 415). Refer to page 77, How to Adjust the Cross Rail.
9. Move the table horizontally until the work is near the tool (Fig. 416). Refer to page 78, How to Adjust the Table Horizontally.
10. Adjust the tool holder and the tool, if necessary, so that the tool holder will clear the angular surface and the tool slide will clear the work (Fig. 417).
11. Raise the tool slide and make certain that the tool can be moved the full length of the angular surface (Fig. 418).
12. Tighten securely the tool holder in the tool post and the tool in the tool holder.
13. Be sure that the clamps on the cross rail are tightened and that the table supports are adjusted properly. (Refer to page 77.)
14. Move the ram to the forward position.
15. Adjust the ram until the cutting edge of the tool is 1/4" beyond the forward edge of the work. Refer to page 81, How to Adjust the Position of the Ram.
16. Bring the ram back to the beginning of the stroke and make sure that there is enough clearance for the tool to drop clear of the work, ready for the cutting stroke.

TAKING THE CUT

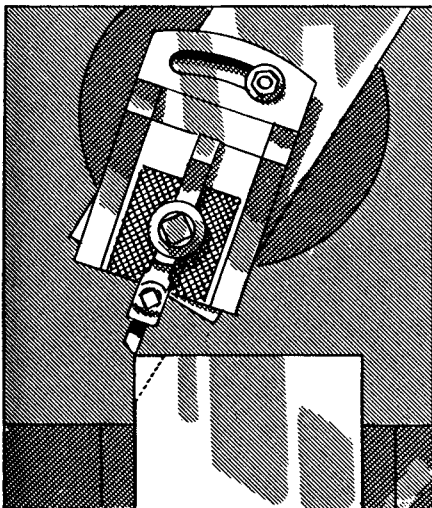

FIG. 419

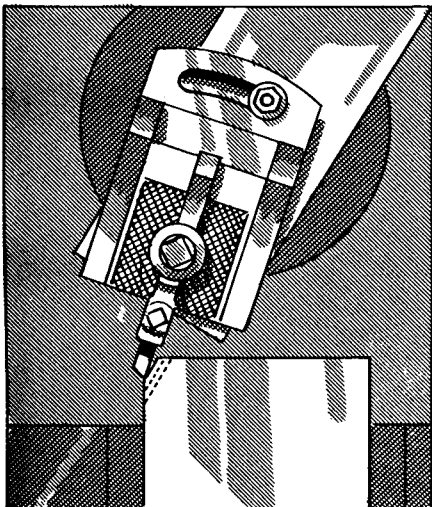

FIG. 420

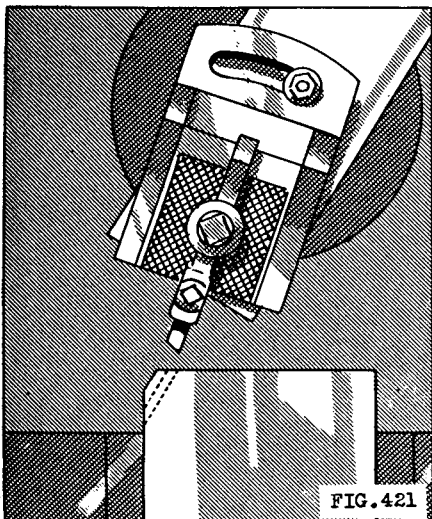

FIG. 421

1. Assume that the length of the cut is 6" and the cutting speed is 80 feet per minute for roughing steel.
2. Either calculate the strokes per minute by using the formula given on page 303 or set the strokes per minute according to the directions given on pages 82 to 88. Choose the instructions to suit the type of shaper that is being operated.
3. Move the work clear of the tool with the table cross-feed handle.
4. Start the machine.
5. Shift the position of the table until the corner of the work is directly below the moving tool (Fig. 419).
6. Feed the tool down with the down-feed crank during the interval when the tool drops clear of the work and before it starts to cut on the forward stroke.
7. Feed the tool down a few thousandths at a time for each cut until the tool stops cutting (Fig. 420).
8. Raise the tool above the work.
9. Move the work about 1/8", or 125 thousandths on the graduated dial, in a direction toward the tool (Fig. 421).
10. Continue to take a number of roughing cuts until about 1/32" is left for finishing.

NOTE: The last of the roughing cuts can be a semifinishing cut and may be used to check the angular setting of the tool head.

11. Stop the machine.
12. Check the angular surface of the work with a protractor as shown in Fig. 422).
13. If the angular surface is incorrect, the head may be adjusted by first loosening the head

lock and then tapping the head in the required direction with the hand or a soft mallet.

14. Tighten the head lock.
15. Start the machine and take a trial cut.
16. Repeat the procedure given in Nos. 11 to 15 until the angular setting of the tool head is correct.

TAKING THE FINISHING CUT

1. Select a finishing tool similar to the one illustrated in Fig. 229 A, page 162.
2. Stone the cutting edge of the tool (page 325).
3. Remove the roughing tool and replace it with the finishing tool.
4. Adjust the tool and the tool holder so that the tool makes an angle of 5° or less with the angular surface, and so that the tool holder and tool slide will have clearance when the tool is at the lower edge of the cut (Fig. 420).
5. Start the machine.
6. Raise the tool and move the work horizontally until the tool just scrapes the edge of the work (Fig. 423).
7. Raise the tool until it is above the top surface of the work.
8. Move the work over the estimated distance for the finishing cut.
9. Take a trial cut by moving the tool down a few thousandths at a time until the tool has moved down far enough to show whether or not it is cutting to the line.

NOTE: As the tool leaves the work, it should split the layout line (Fig. 425). If

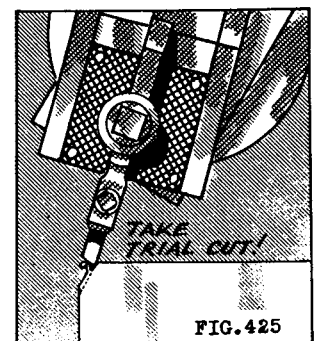
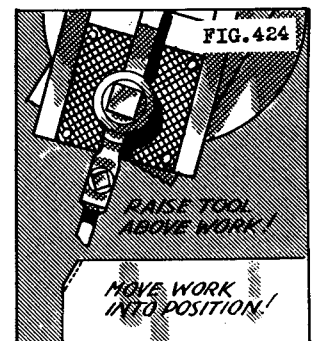
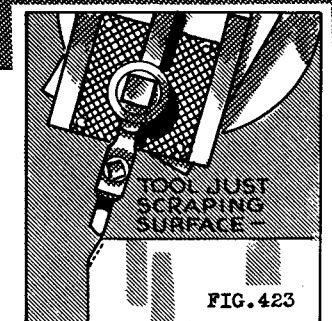
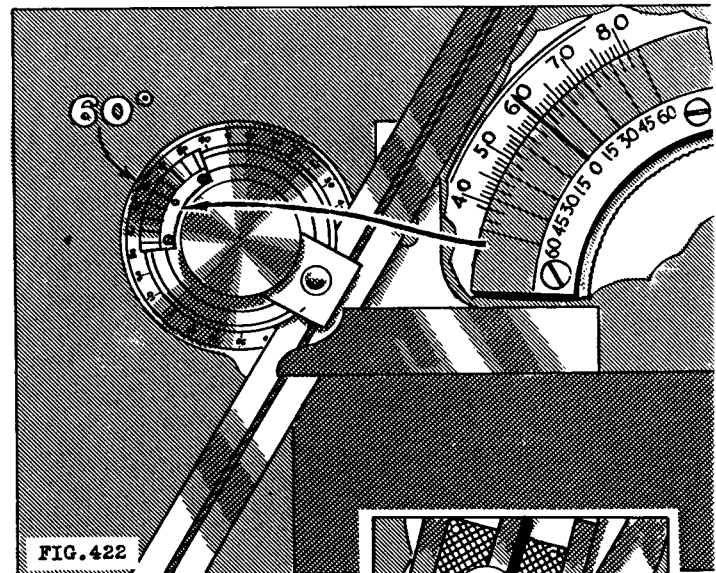

the tool is not cutting to the line, move the work over slightly, but be careful not to cut below the line.

10. Add a little coolant to the surface with a brush, and complete the cut.
11. Stop the machine.

NOTE: The same procedure will be used to cut the angular surface on the opposite side of the work. The head, however, will be swiveled to the left instead of to the right; the clapper box will be moved to the right instead of to the left; and a left-cut tool will be used instead of a right-cut tool. Fig. 426 shows the correct setting of the head in relation to the angular surface of the work.

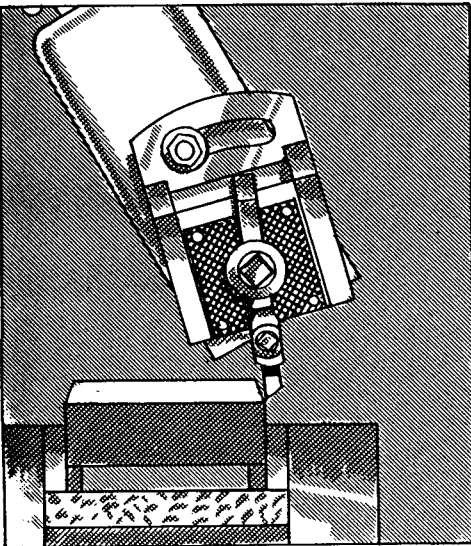
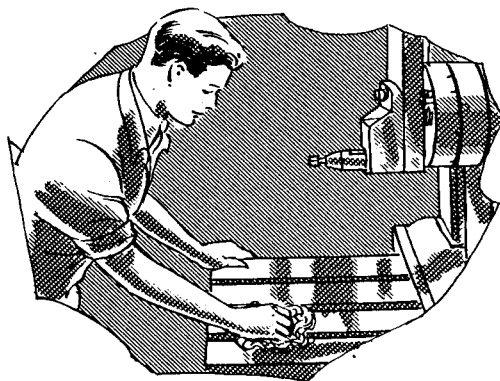

FIG. 426

12. Remove the work from the vise after all operations have been completed.
13. Carefully remove the burrs from the work with a file, and clean the work with a cloth.
14. Remove and clean the parallels, remove the tool from the tool holder, and return each part to its proper place.
15. Brush the chips from the vise and table, and absorb with waste the coolant from the vise and the table.



DESCRIPTION OF SLOTTING • SERRATING SIMPLE FORM CUTTING

Unit 1-T53(C) Pages 259 to 264

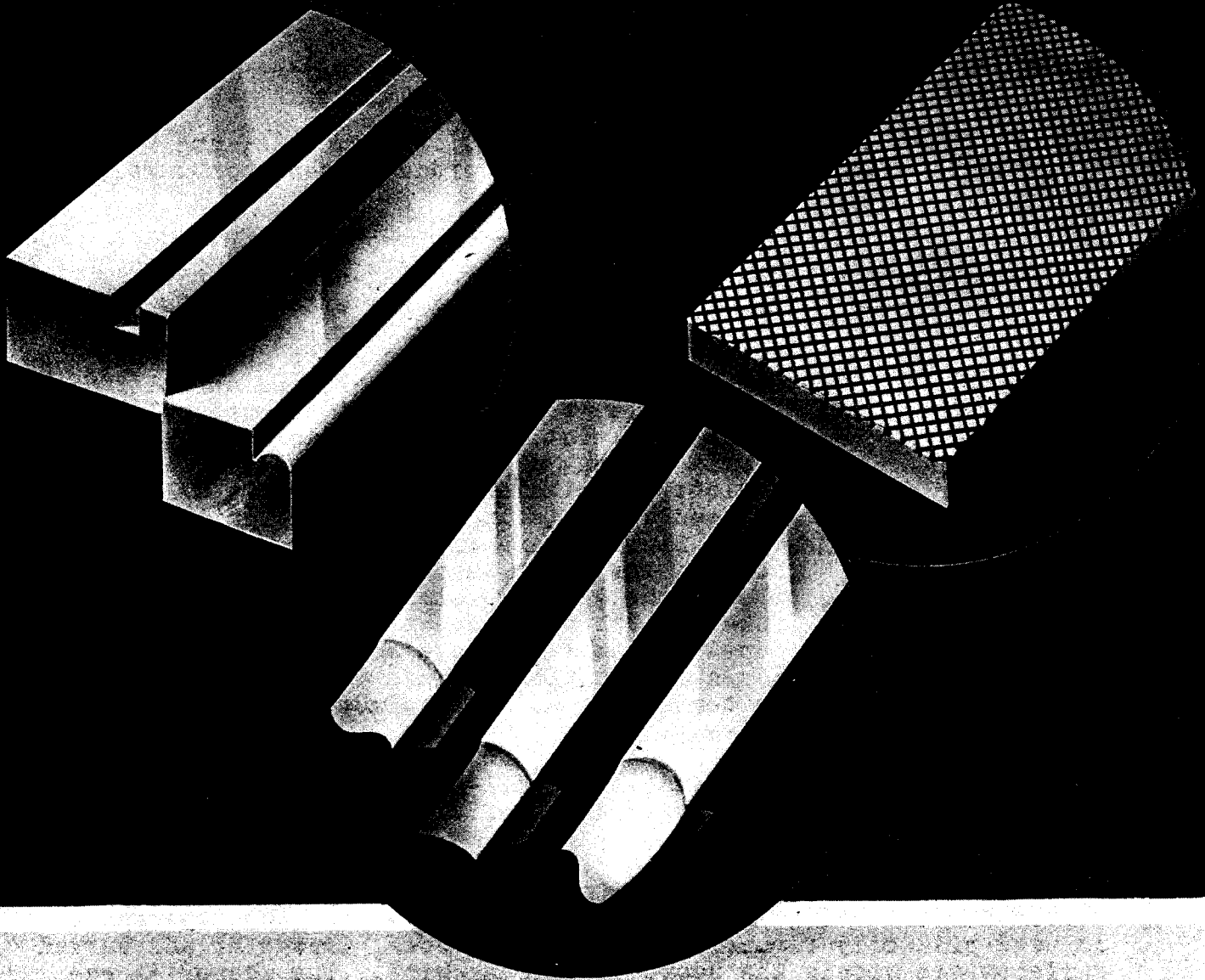

UNIVERSITY OF THE STATE OF NEW YORK
STATE EDUCATION DEPARTMENT
BUREAU OF INDUSTRIAL AND TECHNICAL EDUCATION

DESCRIPTION of SLOTTING • SERRATING • SIMPLE FORM CUTTING

OBJECTIVES OF UNIT

1. To define the processes of cutting-off, slotting, and grooving.
2. To define the process of serrating, and to explain the purpose and use of serrated surfaces.
3. To give a description of contours, or form cuts, and to explain briefly the method used to produce these contours.

INTRODUCTORY INFORMATION

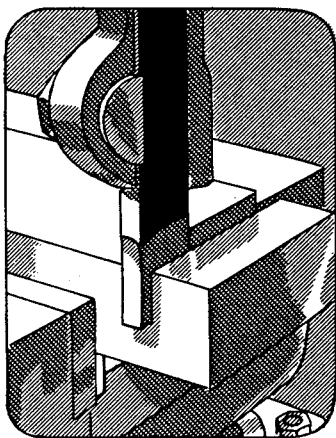

The terms parting, cutting-off, slitting, slotting, and grooving are often used synonymously and sometimes rather loosely. The definitions for these terms, it must be understood, are not all established definitions. For example, there is no established rule which says that a cut less than $3/16$ " wide is a slit or that a cut more than $3/16$ " wide is a slot; nevertheless, in this text, $3/16$ " will be used as a distinguishing and limiting factor. Similar comparisons may be made for some of the other terms in this group. Although the experienced mechanic is not confused by the different terms, the inexperienced operator may have some trouble in making a distinction between them. For use in

this text, then, these terms will be defined more specifically and applied more definitely.

Serrating, on the other hand, is a well-established term, and no difficulty should be encountered in defining the process or understanding its purpose.

Contour, or form, also is an established term which indicates a curved surface or outline. Regardless of the fact that the shaper is used primarily for producing flat surfaces, irregular and curved surfaces are within the scope of this machine. The shaper is especially convenient when an irregularly shaped surface must be machined on a few pieces and when the outline of the surface can be easily shaped by manipulating the work and the tool to form the outline. Then again, large bulky pieces which have an irregular outline often can be placed in the shaper and the contour cut in a very satisfactory manner with a single-point tool.

Parting and cutting-off are terms usually used to indicate the same operation or process. The parting or cutting-off tool is fed down vertically into the material, and each succeeding stroke of the tool cuts deeper into the metal until the parts are separated. Parting, or cutting-off, then, is the process of separating or cutting off material. Parting is not usually considered an accurate process, although pieces are sometimes cut to within a few thousandths of the desired length.

Slitting usually implies a narrow cut. The cut may be of any length, deep or shallow, and, although slitting may be understood to be a severing action, it does not necessarily mean that the metal should be completely severed. In fact, for use in this text, slitting will be limited to a cutting action which does not completely sever the parts. Slits, especially very narrow ones, should not be too deep, because of the difficulties encountered when a deep slit is being cut with a narrow tool. Slitting, therefore, implies that the cut is narrow — not over $3/16$ " wide — and does not completely sever or cut off the metal.

Slotting should be understood to indicate an opening that is wider than a slit. A slot may have one end open, both ends open, or both ends closed. The sides of the slot may be straight or sloping. A tool may be ground to the exact width of the slot and then used to cut the slot in one operation. If the slot is wider than the tool, the tool can be set to cut down one side of the slot first. When this side is cut, the tool can be raised, the work moved over the correct distance, and the tool fed down to complete the second side of the slot. If the slot is unusually wide and deep, a number of cuts can be taken with a wide tool and most of the excess metal removed. Afterwards, the sides and bottom can be finished with side-cutting tools.

Slots which are cut to a standard width and depth to receive rectangular blocks or keys, are called keyways. These keyways are cut in the same manner as slots, the only difference being that they are cut to standard sizes. A further description of keyways will be omitted here because they will be discussed fully in an advanced monograph on shaper operation.

Grooving should be considered the process of cutting a shallow slot. Such cuts may be square, rectangular, V-shaped, or circular.

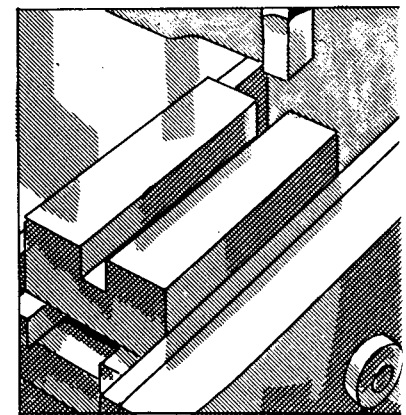
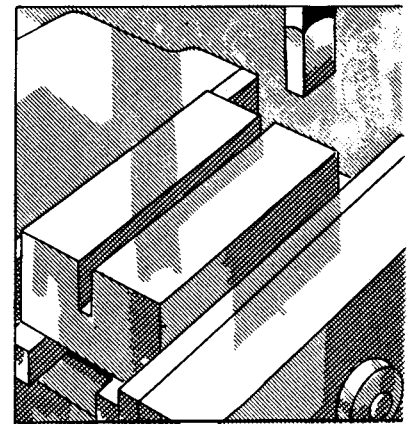
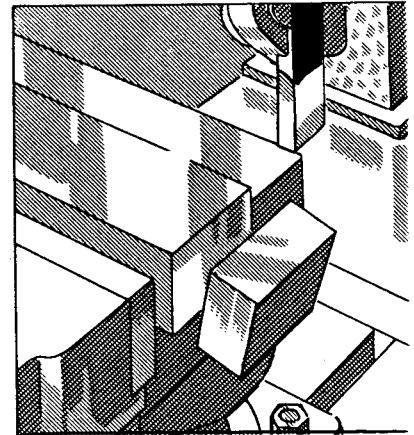

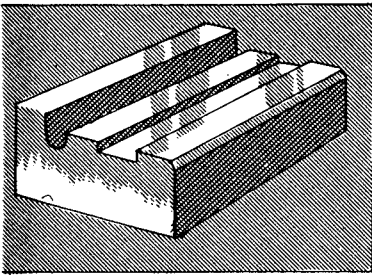

The chief difference between the groove and the slot, however, is that the groove is shallower. One important reason for having grooves in a flat surface is that they act as reservoirs for oil and as channels for the even distribution of the lubricant over areas which need it. They also may act as channels which aid in disposing of dirt and waste material. Grooves are often cut into the face of solids to provide clearance between the surfaces or to reduce slightly the area of the surfaces. Sometimes it is necessary to grind a surface close to a shoulder.

With an ordinary disk wheel, it is impossible to do this without leaving a slight radius in the corner. However, if a groove is cut next to the shoulder, the surface can be ground without approaching too close to the corner.

Serrating is the process of cutting a series of equally spaced grooves upon the surface of a piece of work. The serrating consists of two sets of grooves which cross each other and leave small regularly shaped areas between the cuts.

If a series of grooves is cut parallel with the sides of the work and then a second series is cut at 90° to the first series, small square plane surfaces will be formed, bounded by the sides of the cuts.

The grooves may also be cut at an angle to the sides of the work, and then another series cut at an angle to the first set to form either square- or diamond-shaped areas. The shape of the flat surfaces, therefore, will depend upon the angle at which the grooves cross each other. If the grooves are cut at an angle of 45° with the sides of a square or rectangular piece, the flat areas will be square but the corners will be perpendicular to the sides of the work. If, on the other hand, the grooves cross each other at an angle other than 90° , the areas will be diamond-shaped.

The purpose of serrating is to roughen the surface slightly and to increase its holding power. Although the main reason for serrating is to prevent slipping, it is frequently produced for ornamental and decorative purposes. The shapes of the grooves are not standardized. They are usually V-shaped with flat or rounded surfaces

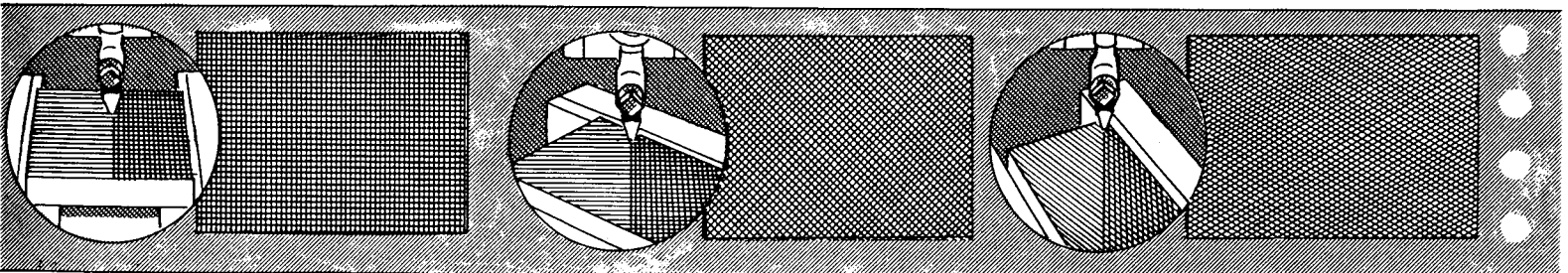

at the bottom of the two tapered sides. In addition, there is apparently neither standard depth nor distance between the grooves. The depth and distance between the grooves determine the area or size of the numerous flat surfaces.

The piece to be serrated is supported upon parallels and held in the vise. Then a horizontal cut is taken across the top of the work, or, if the surface has been previously machined, the work is leveled in the vise without taking a cut. Finally, the vise is set in position for cutting one set of grooves, and afterwards swiveled to the desired angle for cutting the other.

SIMPLE FORM CUTTING

In addition to the straight-line cuts which are made horizontally, vertically, or angularly, irregular or curved surfaces may also be produced. These curved surfaces are called contours, and, although horizontal, vertical, or angular surfaces may connect the curved parts, only the curved portion should be considered the contour proper. The curves may be single-radius contours, or they may be a combination of many curves.

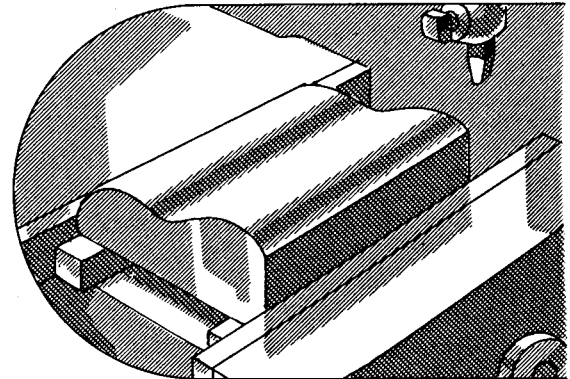

Often the form of the contour is laid out on the end of the piece, and, when this is the case, it is the duty of the operator to manipulate the work and the tool so that the finished surface conforms to the contour line. The contour may be produced in one of the following ways.

One method makes use of a single-point tool in the tool holder, and then, after each cut, the work is moved sideways and the tool vertically with the hand controls so that the path of the tool forms a curve. When this method is used, some experience and skill are required to produce a curve that is both regular and smooth.

A second method of cutting a contour is to engage the table feed so that the movement of the work is controlled mechanically while the operator controls the downward movement of the tool by hand. When this method is being used, the operator can concentrate on the downward movement of the tool. With a little experience, a very satisfactory and regular curve can be produced in this manner.

A third procedure can be followed by using a number of tool bits that have been ground to suit the different parts of the contour. The contour should be roughed out first; then each tool should be set and brought down to cut a definite part of the curve. The tools should be set so that each part of the contour joins the other in a continuous curve.

A fourth method of shaping a contour is to use a single forming tool to produce the curve. The cutter, or forming tool, may be a tool bit ground approximately to suit a simple curve, or it may be a specially made cutter accurately shaped to conform to an irregular outline and one which involves considerable time and work. The surface of the work which is to be shaped may be roughed out first with a single-point tool and then finished with a forming cutter.

Under some circumstances, the forming tool may be fed down to the proper depth before the work has been roughed out. When this procedure is used, the tool should be held with the cutting edge behind the point of support, or fulcrum, to allow the tool to spring away from the work when the pressure builds up. In addition, the speed must be reduced considerably in order to preserve the cutting edge and also to provide the increased power which is developed at the slower speeds. Furthermore, a coolant must be used with those metals which require one. The coolant not only carries away some of the generated heat, but also acts as a lubricating medium to help preserve the cutting edge of the tool.

For testing the shape of the contour, a metal gage is often used. A gage is usually a piece of sheet metal, the edge of which has been accurately shaped to conform to the exact shape of the contour. The gage is placed on the machined surface, and, by observation, the shape of the surface is compared with that of the gage. If the contour has irregular spots, they may be smoothed off by reworking the high spots with the tool. Sometimes a file may be used to level off the ridges and to smooth off the curve. In many cases, however, a smooth regular surface is not necessary and, therefore, the necessity of making a special gage to suit the contour of the surface is eliminated.

S E L E C T E D R E F E R E N C E S

- | | |
|------------------|---|
| DeLeeuw, A. L. | Metal Cutting Tools
McGraw Hill Book Co. |
| Burghardt, H. D. | Machine Tool Operation
Part II
McGraw Hill Book Co. |



HOW TO CUT SLOTS, SERRATIONS, SIMPLE CONTOURS

Unit 1-P53(C) Parts I, II, and III Pages 265 to 292

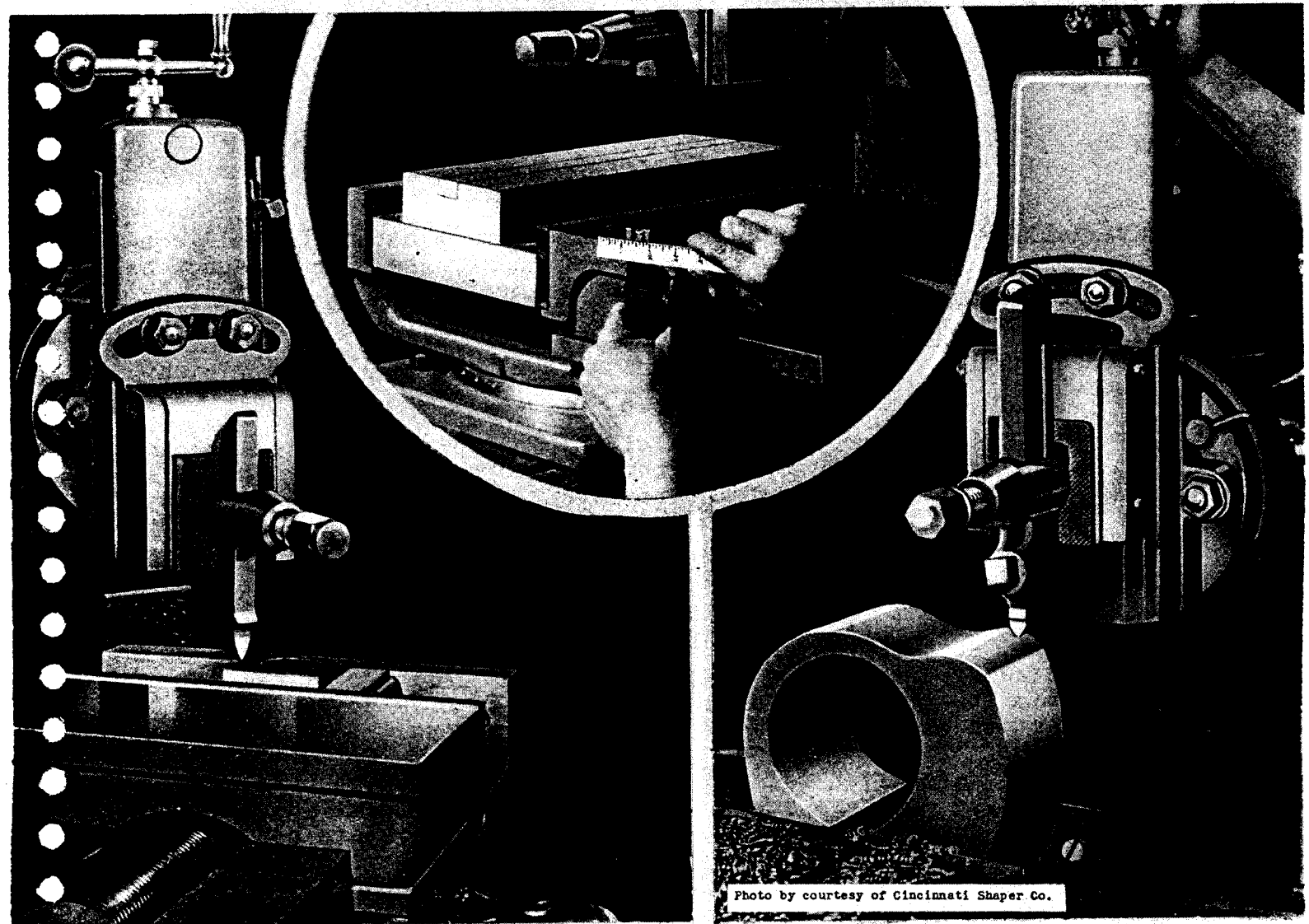

Photo by courtesy of Cincinnati Shaper Co.

UNIVERSITY OF THE STATE OF NEW YORK
STATE EDUCATION DEPARTMENT
BUREAU OF INDUSTRIAL AND TECHNICAL EDUCATION

OBJECTIVES OF UNIT

1. To explain how to cut off material and how to cut slots.
2. To explain how to cut a serrated surface.
3. To explain how to produce simple form cuts or contours.

INTRODUCTORY INFORMATION

Material is often cut off in the shaper when it cannot be held conveniently in the power saw or when the ends of the pieces cannot be finished satisfactorily and with the desired degree of accuracy by this means. For example, material which is too large for the saw vise may be clamped to the shaper table where pieces may be cut off accurately in respect to length and with a reasonably good finish on the ends.

Slots which vary considerably in width, in depth, and in shape can be cut in the shaper, and it is these factors which determine to a large extent the cutting procedure itself. For example, a single cut made with a tool ground to the exact width may be satisfactory for cutting a narrow slot, but for a wide slot, or one of irregular shape, several cuts will be more expedient.

The pattern of a serrated surface is determined by a combination of factors, such as the shape of the tool used to cut the grooves, the spacing of the grooves and, finally, the position of the job in relation to the stroke of the ram. A change in any one of these factors alters the design of the serrations.

Instructions are given for two procedures which may be used to produce simple contours or forms; in one, the vertical adjustment of the tool and the horizontal movement of the work are both controlled by hand; in the other, the work is moved horizontally by means of the automatic feed, and the vertical movement of the tool is controlled by hand. Both these methods require judgment in determining the amount of movement of the tool and the work. First attempts to shape the curve may be unsatisfactory, but with a little experience and a little care, good results should be obtained.

TOOLS AND EQUIPMENT

Shaper
Mill File
Wrenches
Coolant
Tool Holder

Measuring and Gaging Tools
Goggles or Shield
Magnifying Glass
Cutting Tools
Brush for Coolant

Brush for Chips
Rawhide Mallet
Cleaning Cloth
Slot Cleaner
Parallel Blocks

HOW TO CUT OFF AND CUT SLOTS

PROCEDURE

MOUNTING THE VISE AND THE WORK

1. If it is necessary to mount the vise on the table, follow the directions given on pages 119 to 121. Select the procedure to suit the style of the vise.
2. Set the vise at 90° to the direction of the stroke. The zero marks on the vise will coincide with the zero graduations on the base (Fig. 427).
3. Thoroughly clean the face of the jaws and the working surface of the vise.
4. Select two parallel blocks that will hold the top surface of the bar about even with the top of the vise jaws (Fig. 427). The parallels may be omitted if the bar is large enough to reach the top of the vise.
5. Clean the parallels and place them in the vise.
6. Use whatever protecting strips are necessary to safeguard the work, the top of the parallels, and the faces of the vise jaws from injury. Refer to note on page 244 for this information.
7. Place the bar on top of the parallels, allowing it to extend beyond the right side of the vise a distance about $1/4"$ more than the length of the piece which is to be cut off.
8. Hold the work down on the parallels and clamp the vise securely.
9. Tap the work down on the parallels with a lead or rawhide mallet until the pieces of paper are gripped between the bottom of the work and the top of the parallels (Fig. 427).

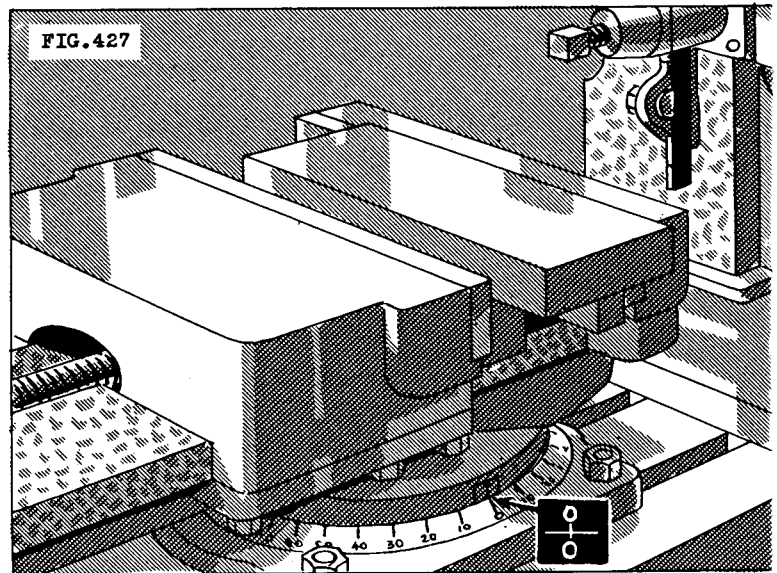

CAUTION The tap with the mallet must be heavy enough to seat the work on the parallels, but not heavy enough to cause the work to rebound from the parallels.

SETTING THE TOOL AND THE TOOL HEAD

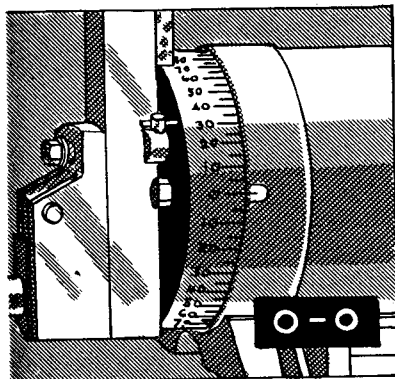

FIG. 428

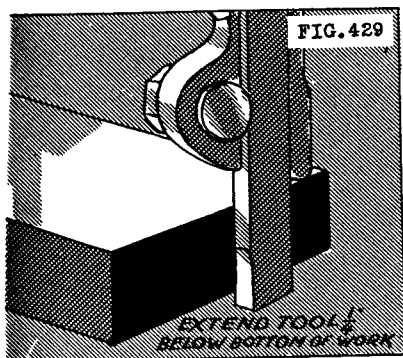

FIG. 429

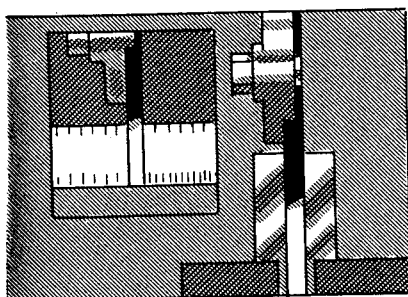

FIG. 430

1. Examine the setting of the tool head (Fig 428) and, if it is not exactly in the vertical position, make the necessary adjustment. This is important, for if the tool is not fed down in a position that is exactly perpendicular, it will bind in the slot. An alternate method of setting the tool head with a square is explained on page 213, steps No. 2 to No. 5.
2. Select a straight cutting-off tool (Fig. 210) and a blade as shown on page 166.
3. Place the assembled tool and tool holder in the tool post, being certain that the heel of the tool holder clears the plate and that the tool projects beyond the holder a distance about 1/4" greater than the height of the work (Fig. 429).
4. Manipulate the tool and work until the top surface of the work can be used to set the tool square (Fig. 430). A small square, the edge of a scale, or a small square block may be used to set the tool square with the top surface of the work. (Refer to page 172 for setting the tool square.)
5. Tighten the tool holder in the tool post and the tool in the tool holder.
6. Check the setting to make certain that the position of the tool did not change during the tightening process.

ADJUSTING THE SHAPER PRIOR TO OPERATING

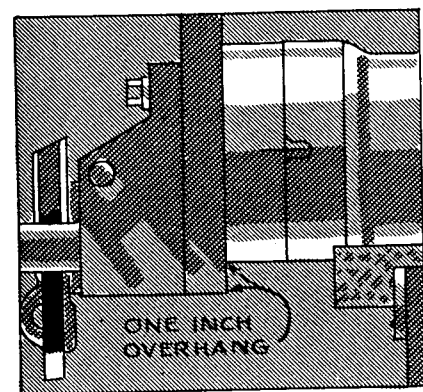

FIG. 431

1. Adjust the tool slide so that it is projecting not more than 1" beyond the bottom edge of the swivel block (Fig. 431).
2. Move the table horizontally until the side of the tool is about even with the edge of the work (Fig. 432). Refer to page 78, How to Adjust the Table Horizontally.
3. Raise or lower the table until the cutting edge of the tool is slightly below the bottom of the work (Fig. 429). Refer to page 77, How to Adjust the Cross Rail.

4. Raise the tool slide until the tool is above the top of the work (Fig. 432).
5. Adjust the stroke of the ram. Refer to page 79, How to Adjust the Stroke, and to page 92, How to Adjust the Stroke on the Hydraulic Shaper.

CAUTION Often a tool of this kind has a tendency to bind in the slot, and, as a result, it does not release from the slot on the return stroke in time to allow the tool to drop clear of the work and ready for the next cut (Fig. 436). To overcome this, $1/4"$ to $1/2"$ more than the usual $1/2"$ may be allowed between the work and the beginning of the stroke (Fig. 433). This will allow the tool to be pulled clear of the slot.

6. Adjust the position of the ram so that the cutting edge of the tool is $1/4"$ beyond the front end of the work when the ram is in the forward position (Fig. 433). Refer to page 81, How to Adjust the Position of the Ram on the Crank Shaper, and to page 92, How to Adjust the Position of the Ram on the Hydraulic Shaper.

7. Set the speed of the machine for a roughing cut. Make the necessary calculations to suit the kind of material and the length of the stroke. Refer to page 82, How to Adjust the Speed of the Crank Shaper, and to page 94, How to Adjust the Speed of the Hydraulic Shaper. (For speed calculations, refer to page 303.)

TAKING THE CUT

1. Move the ram to bring the tool directly above the work (Fig. 434).
2. Move the tool down with the down-feed crank until the tool nearly touches the work (Fig. 435).
3. Place a scale against the side of the tool and move the table horizontally until the edge of the work coincides with the graduation on the scale (Fig. 435).

HAVE ENTIRE SET-UP CHECKED BY YOUR INSTRUCTOR



Oil the shaper as directed in How to Oil the Shaper, beginning on page 47.

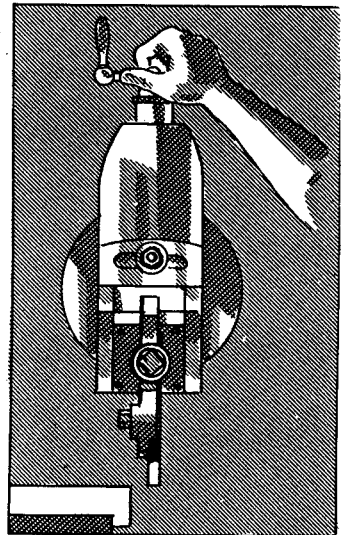

FIG. 432

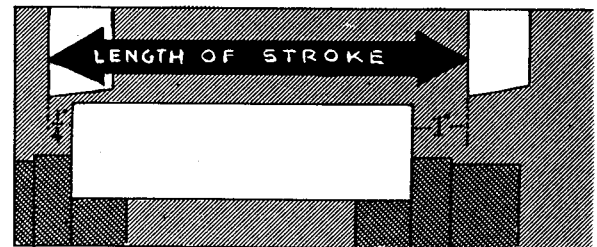
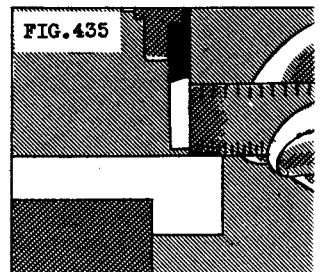
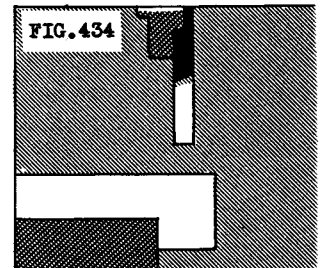

FIG. 433



4. Start the machine.

CAUTION Stand clear of the ram when the machine is started. This is merely a precautionary measure in case some adjustment has been overlooked.

5. Move the tool down a few thousandths at a time until the tool starts to cut.

CAUTION Goggles or a shield should be worn to protect the eyes from flying particles. Keep the head to one side of the tool and as far away from the work as practicable.

6. Stop the machine; check the length of the piece, and make any necessary adjustments by moving the table horizontally to the left or to the right.
7. Start the machine; apply a small quantity of coolant with a brush, and continue to move the tool down a few thousandths at the beginning of each stroke.

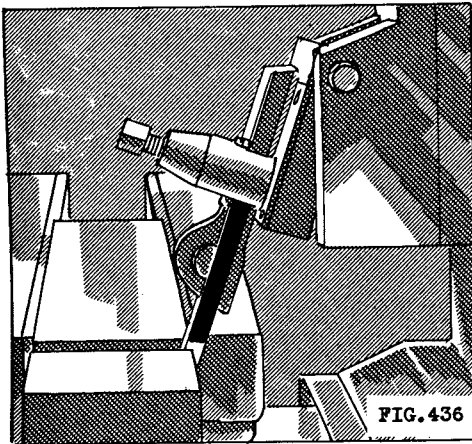

8. Observe the action of the tool as it cuts deeper into the metal. If the tool binds in the slot, look for one of the following reasons: (1) the cutting edge of the tool may be dull; (2) the tool may be incorrectly set; (3) the clearance angles of the tool may be incorrectly ground.
9. Remedy the causes of the above conditions by regrinding and resetting the tool. (Refer to page 166 for tool clearance angles.)
10. Continue cutting down until the piece has been completely cut from the bar.

CAUTION To avoid injury if the piece should fall from the bar, keep the hands and feet from underneath the part being cut off.

11. Stop the machine; raise the tool; and move the work out from the vise, ready for the next cut.
12. Remove the work from the vise after all operations have been completed.
13. Remove and clean all tools, and return each part to its proper place.
14. Brush the chips from the vise and the table.

CUTTING A SLOT

PROCEDURE

MOUNTING THE VISE AND THE WORK

1. If it is necessary to mount the vise on the table, follow the directions given on pages 119 to 121. Select the procedure to suit the style of the vise.
2. Set the vise parallel with the direction of the stroke. The zero mark on the vise will coincide with the 90° graduation on the base (Fig. 437).
3. Mount the work in the vise, being careful to follow the procedure given on page 191, How to Mount the Work in the Shaper Vise.

SETTING THE TOOL

1. Set the tool head in a vertical position by using the graduations on the swivel block, or by placing the blade of a square against the side of the tool slide (Fig. 438).
2. Select a tool holder as shown on page 155, Fig. 205.
3. Select a tool bit for slot cutting as shown on page 166, and grind it to the exact width of the slot.
4. Assemble the tool in the tool holder so that the cutting edge of the tool will be held behind the point of support (Fig. 439). Have the tool project beyond the tool holder about 1/4" more than the depth of the slot.
5. Place the assembled tool, and the tool holder, in the tool post and tighten the tool-post screw to hold the tool holder and the tool temporarily in a vertical position.

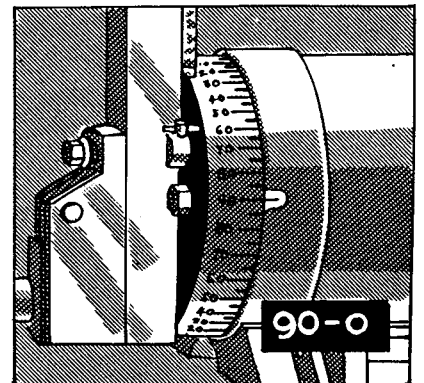
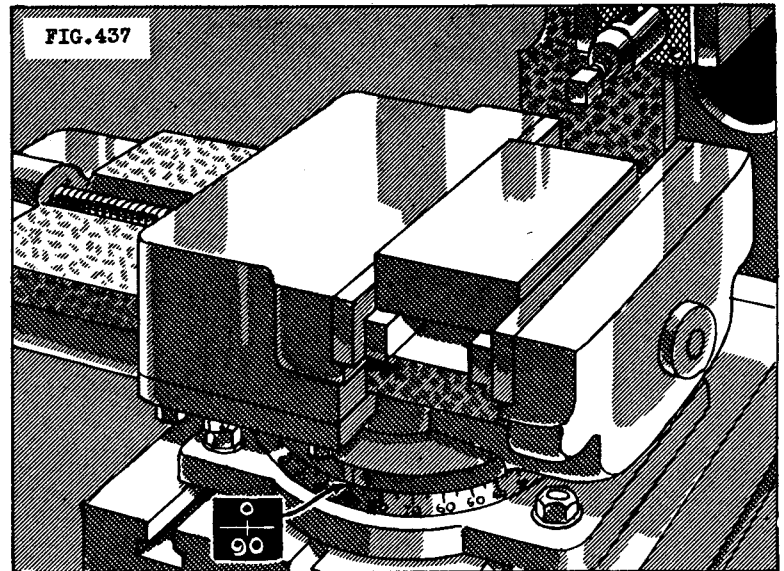

FIG. 438

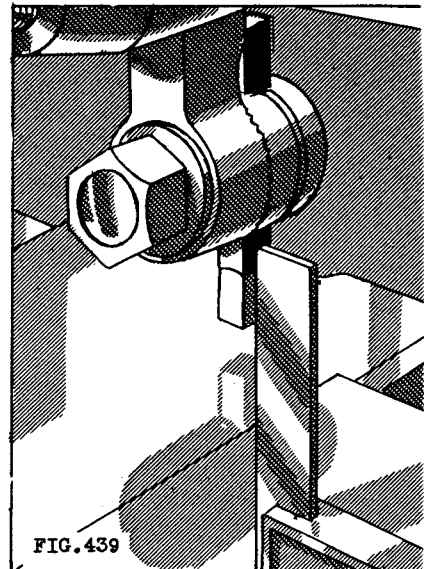

FIG. 439

6. Move the tool and the work until the top surface of the work can be used to support a gage to set the tool square (Fig. 439).
7. Use a small square, the edge of a scale, or a small square block to set the tool square with the surface (Fig. 439). (Refer also to pages 268 and 171 for setting the tool square.)

NOTE: An experienced mechanic will often set the tool square by sighting the tool with the eye. Then, if the tool should bind on one side as it feeds into the slot, a further adjustment is made. However, when the tool is set by using a squared edge, first against one side and then against the other, the trial-and-error procedure is eliminated.

8. Tighten the tool-post screw to hold the tool holder in the tool post, and tighten the tool securely in the tool holder.
9. Check the tool setting to make certain that the tool did not change during the tightening process.

ADJUSTING THE SHAPER PRIOR TO OPERATING

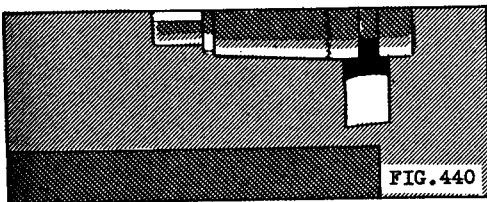

FIG. 440



FIG. 441

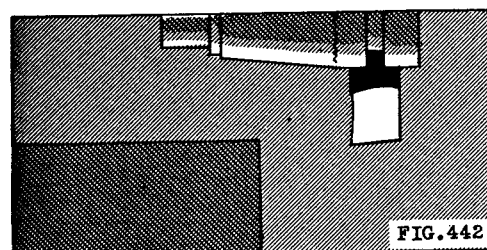

FIG. 442

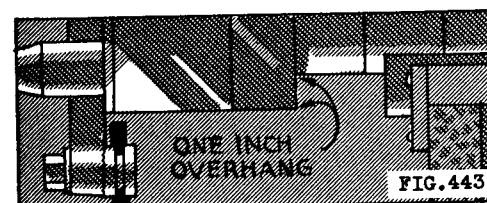
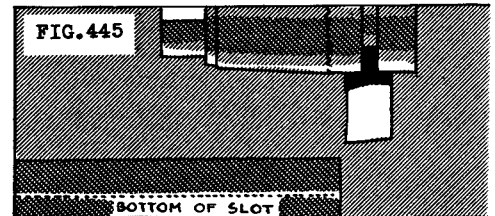
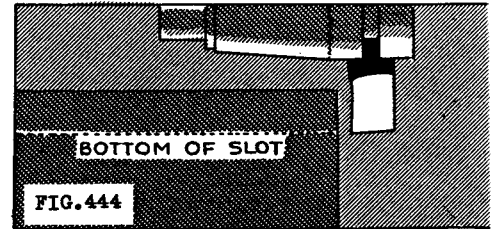

FIG. 443

1. Raise the tool slide so that the tool is above the top surface of the work (Fig. 440).
2. Adjust the stroke of the ram. Allow 1/4" for the tool to travel beyond the forward edge of the work and allow about 1" between the cutting edge of the tool and the edge of the work when the ram is at the beginning of the stroke. This 1" clearance will enable the tool to pull clear of the work if it should bind in the slot (Fig. 441). Refer to Caution on page 269.
3. Adjust the position of the ram so that the cutting edge of the tool is about 1/4" beyond the front edge of the work when the ram is in the forward position (Fig. 441). Refer to page 81 for adjusting the ram on the crank shaper and to page 92 for adjusting the ram on the hydraulic shaper.
4. Move the ram back until the tool is at the beginning of the stroke (Fig. 442).
5. Adjust the tool slide so that it is projecting not more than 1" beyond the bottom edge of the swivel block (Fig. 443).

6. Adjust the table until the cutting edge of the tool is level with the bottom of the slot (Fig. 444). The tool is now set so that it will reach the bottom of the slot without the tool slide projecting more than 1" below the bottom edge of the tool head. Refer to page 77 for adjusting the table vertically.
7. Make certain that the cross-rail clamps are tightened and that the table support is adjusted properly.
8. Raise the tool until it is above the top surface of the work (Fig. 445).
9. Set the speed of the machine for a roughing cut, basing the selection on the kind of material and the length of the piece. Refer to page 82, How to Adjust the Speed of the Ram, and to page 94, How to Adjust the Speed of the Ram on a Hydraulic Shaper. (For speed calculations, refer to page 303.)



CAUTION

Check carefully before starting the machine to see that the speed of the ram is correctly set. An excessive speed and a long stroke may damage the shaper.

CUTTING THE SLOT



Oil the shaper as directed in How to Oil the Shaper, beginning on page 47.

1. Move the ram forward until the tool is above the top of the work (Fig. 446).
2. Move the tool down until the tool touches the top surface of the work and then set the graduated collar on the down-feed screw at zero (Fig. 447).
3. Raise the tool slightly (Fig. 448) to prevent it from dragging on the surface of the work during the time the work is being moved into position.

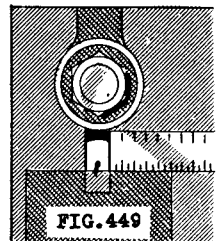
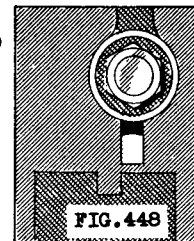
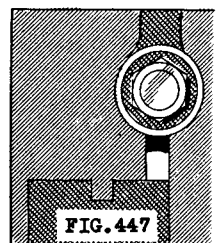
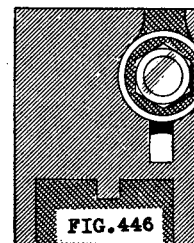

NOTE: A number of procedures may be used to set the tool: (1) the tool may be set to the layout line; (2) a scale may be used to locate the side of the tool with the edge of the slot (Fig. 449); (3) the work may be moved a distance indicated on the graduated collar that is attached to the table feed screw (Figs. 450 and 451).

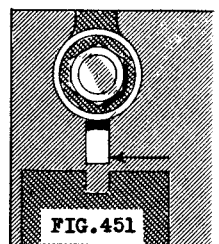
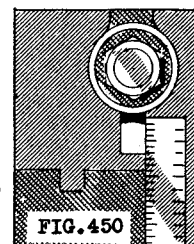

4. If the tool is set to the layout line, move the work until the sides of the tool coincide with the layout lines representing the position of the slot.
5. If a scale is used to set the tool, place the edge of the scale against the side of the tool and then move the work until the desired graduation on the scale coincides with the side of the work (Fig. 449). A magnifying glass may be used to see whether or not the side of the work and the graduation on the scale coincide.
6. If the tool is set with the aid of the graduations on the collar of the feed screw, first move the work until the side of the tool is even with the side of the work (Fig. 450); next, set the graduated dial at zero, making certain that the back lash is out of the screw; and, finally, move the work the desired distance (Fig. 451), using the graduated collar to indicate the distance the table and the work have been moved.

NOTE: An alternate method of setting the side of the tool even with the side of the work is shown in Fig. 452. When this method is being used, raise the tool after it has been set lightly against the work, and then move the work over the desired distance plus the width of the tool.

7. Check the setting.

8. Calculate the number of complete turns and the additional partial turn of the down-feed screw that must be made in order to

feed the tool down to the correct depth of the slot. For example, if the graduated collar is divided into two hundred divisions and the slot to be cut is $3/8$ " (.375") deep, the down-feed crank will be given one complete turn and one hundred seventy-five divisions on the graduated dial.

9. Start the machine and feed the tool down a few one-thousandths at a time during the interval when the tool drops clear of the work on the return stroke and before it starts again on the forward stroke.

CAUTION Do not use a coolant on cast iron.

10. Feed the tool down until the full depth of the cut has been attained. Since the graduated collar was set at zero, as instructed in step No. 2, the down-feed crank will finally make one complete turn and one hundred seventy-five divisions on the graduated collar.

11. Stop the machine and test the depth of the slot with a scale, a depth gage, or a micrometer depth gage (Fig. 453).
12. Raise the tool clear of the slot.

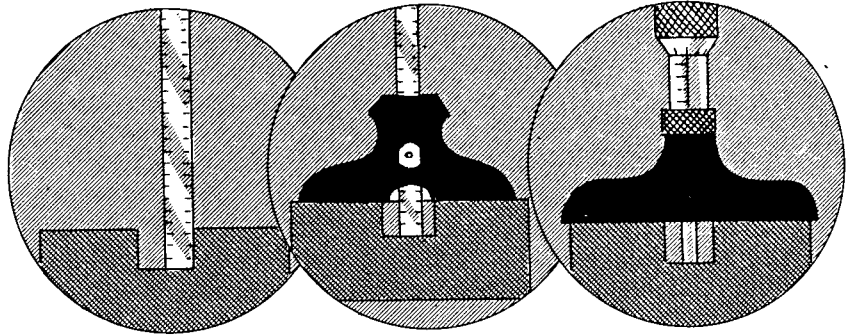

FIG. 453

NOTE: If a slot is being cut with a tool ground to the exact width, the slot will be finished when the correct depth has been obtained. When, however, a slot is to be cut wider than the width of the tool, the procedure will be the same for cutting the first side of the slot. In this case, do not change the setting of the work because this can be used as a starting position for the second cut of a slot.

CUTTING A SLOT WIDER THAN THE TOOL

1. Follow the procedure given in the preceding section for cutting the first side of the slot.
2. Subtract the width of the tool from the width of the slot (Fig. 454). For example, if the width of the slot is $3/8$ " and the width of the tool is $1/4$ ", the amount left after subtracting $1/4$ " from $3/8$ " will be $1/8$ " (.125").
3. Make certain that the back lash is out of the table feed screw; then move the work over the desired distance. Use the graduated collar to indicate the space through which the table must be moved.
4. Start the machine and take a trial cut about $1/64$ " (.015") deep (Fig. 454).
5. Stop the machine and check the width of the slot with a scale or a gage block (Figs. 455 and 456).
6. Compensate for any inaccuracy in the width of the slot by moving the table to the left

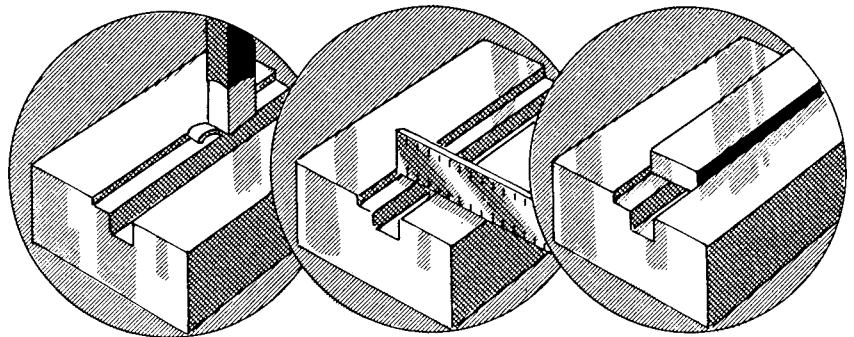

FIG. 454

FIG. 455

FIG. 456

if the slot is too wide, and by moving the table to the right if the slot is too narrow.

NOTE: If the adjustments are made carefully in the beginning, the width of the slot should be correct to within a few one-thousandths of an inch. Also, a trial cut should not be taken too far over when the width of the slot is being machined, and not cut too deep when the depth of the slot is being cut. These precautions allow the cut to be increased after the measurements have been checked.

7. Start the machine and cut down to the full depth of the slot when the tool setting is correct.
8. Stop the machine and make a final check of the depth and width of the slot.

NOTE: Sometimes the slot is wider than twice the width of the tool. When this is the case, the center may be cut out first and then the sides and the bottom of the slot trimmed afterwards.

CUTTING A SLOT WIDER THAN THE DOUBLE WIDTH OF THE TOOL

1. Cut out the material in the center of the slot, leaving about .015" on each side for trimming and the same amount at the bottom of the slot for finishing (Fig. 457). If the tool is dull, regrind it for finishing the slot.

NOTE: Use one of the methods given on page 274, starting with direction No. 4, for locating the tool the proper distance from the side of the work. If a more accurate method is required, a micrometer may be used to check the measurements, and the following procedure should be used.

2. Move the tool until it is in a position so that it just touches the top surface of the work and then set the down-feed dial at zero (Fig. 458).
3. Move the work so that the side of the tool is set to trim lightly the right side of the roughed-out slot (Fig. 459).
4. Take a trial cut; then stop the machine and measure the distance A (Fig. 460) with a micrometer. The distance must be

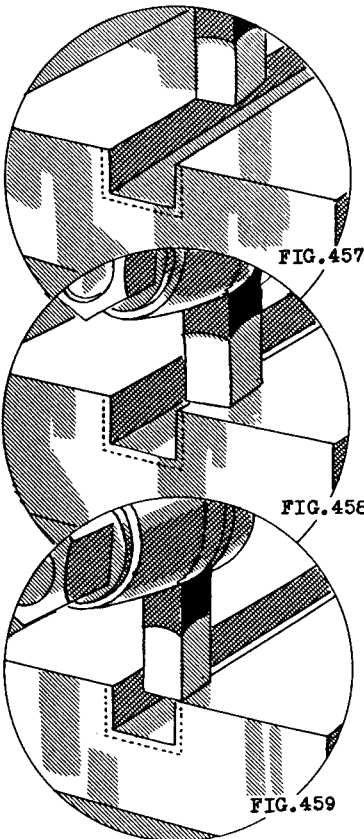

greater than the required dimension because it is used as an approximate distance to gage the final cut.

5. Check the distance at the front A and at the back B of the slot (Fig. 460) in order to test the parallelism of the slot with the side of the work. If the slot is not parallel with the side of the work, proceed as follows.
6. Loosen slightly the nuts on the base of the vise; then tap the vise to the right if the distance A is the greater, or to the left if the distance B is the greater (Fig. 460).

NOTE: If preferred, an indicator may be used to determine the distance the vise must be swiveled either to the right or to the left.

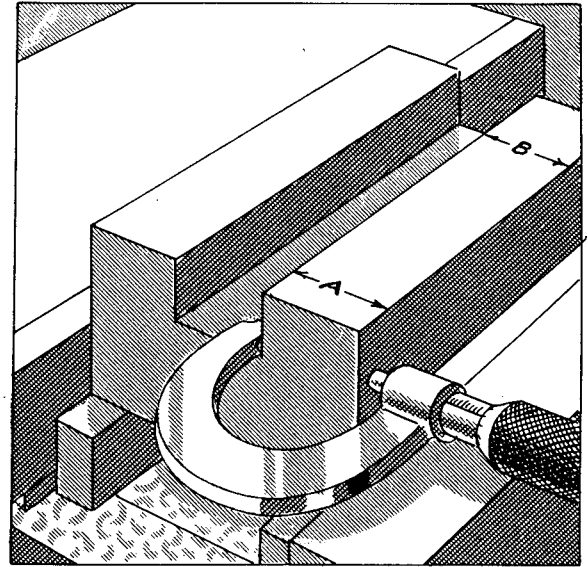

FIG. 460

7. Tighten the nuts on the vise.
8. Move the work to the left two or three one-thousandths of an inch.
9. Take another trial cut and stop the machine.
10. Check the distances A and B again. Then, when the cut is parallel with the side of the work, determine how many one-thousandths of an inch the work must be moved to locate the edge of the tool at the correct distance from the side of the work.
11. Make certain that the back lash is out of the table feed screw; then move the work to the left the desired number of one-thousandths, using the graduated collar to indicate the distance.
12. Start the machine and move the tool down a few one-thousandths at a time, trimming the side within about .003" of the full depth of the slot (Fig. 461).
13. Stop the machine and set the tool to trim the opposite side of the slot (Fig. 462).
14. Start the machine and take a trial

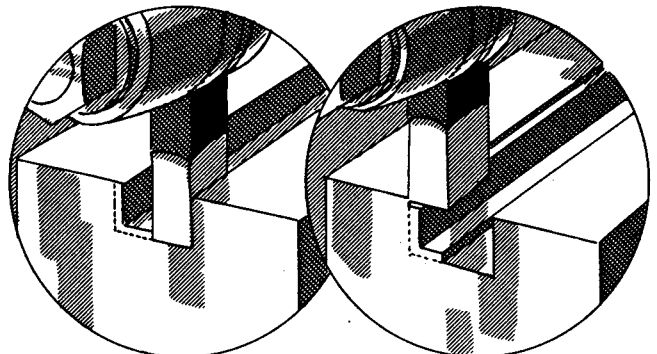

FIG. 461

FIG. 462

cut about $1/64$ " deep (Fig. 462).

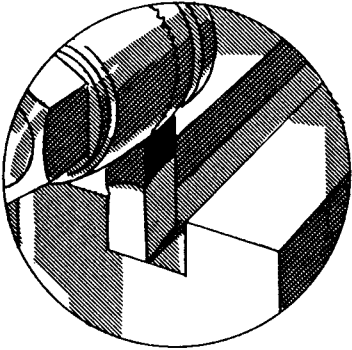

FIG. 463

15. Stop the machine. Use a scale or a gage block to measure the width of the slot, and, when the correct setting of the tool has been obtained, cut down to within about $.003$ " of the full depth of the slot (Fig. 463).

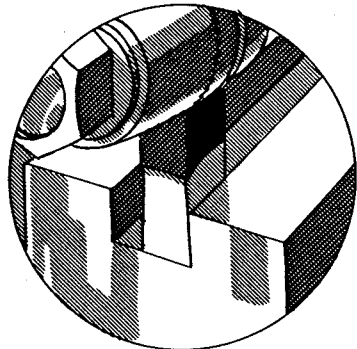

FIG. 464

16. Without changing this setting, move the work to the left with the table feed screw a few one-thousandths at a time until the tool has passed to the other corner of the slot (Fig. 464).

17. Stop the machine and measure the depth of the slot with a depth micrometer. Note how many one-thousandths more the depth of the slot must be cut.

18. Move the ram so that the tool is clear of the cut.

19. Move the tool down the required distance, using the graduated collar to indicate, in one-thousandths of an inch, the distance moved.

20. Start the machine; then carefully feed the work to the right until the tool has cut to the opposite corner of the slot (Fig. 465).

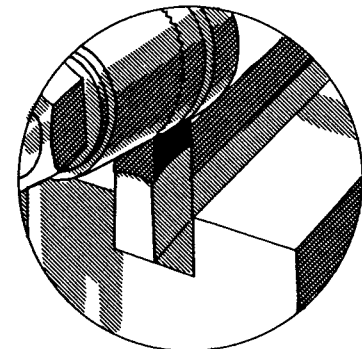

FIG. 465

21. Make a final check of the width and the depth of the slot.

NOTE: An alternate method of cutting the slot is shown in Fig. 466. The two sides are first cut down to the full depth of the slot; then the excess metal is cut out and the bottom of the slot is cut to the proper depth.

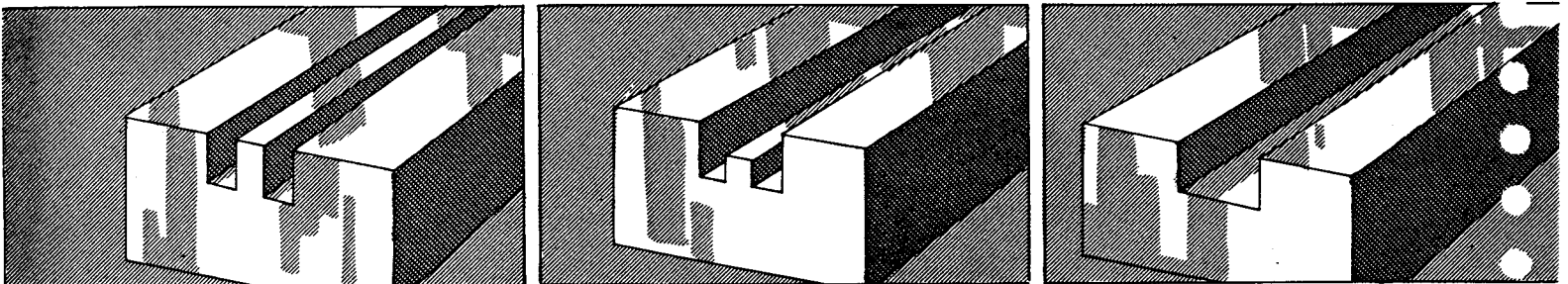

FIG. 466

HOW TO CUT SERRATIONS

AT RIGHT ANGLES TO SIDES OF THE WORK

PROCEDURE

MOUNTING THE WORK IN THE VISE

1. Set the vise at 90° to the direction of the stroke. The zero mark on the vise will coincide with the zero mark on the base (Fig. 467).
2. Mount the work in the vise, following the procedure given on page 191, How to Mount the Work in the Shaper Vise.

SETTING THE TOOL

1. Set the tool head in a vertical position, using the graduation on the head to indicate when the head is in a vertical position (Fig. 468).
2. Select a tool holder as shown on page 155, Fig. 209.
3. Use a tool bit ground as shown in Fig. 474.

NOTE: Since it is not necessary to have a sharp corner at the bottom of the groove, a flat of about $1/64$ " should be ground on the extreme point of the tool as illustrated in Fig. 469.

4. Place the tool in the tool holder so that the point of the tool projects about $1/2$ " beyond the end of the tool holder (Fig. 468).
5. Tighten the tool-holder set screw just enough to hold the tool in position.
6. Place the assembled tool and tool holder in the tool post in a vertical position and have the end of the tool holder project about $1-3/4$ " beyond the bottom of the clapper box (Fig. 468).

NOTE: If greater accuracy is required when the tool is being set, a center gage may be used to square the point of

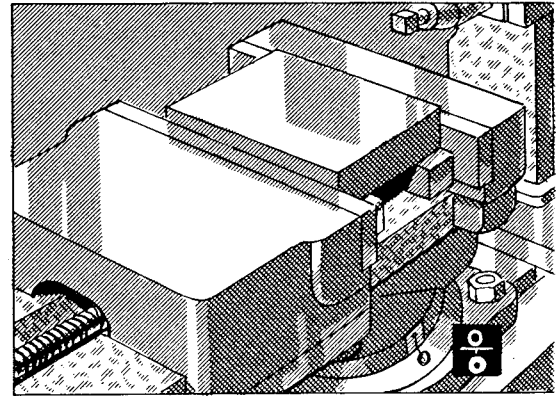

FIG. 467

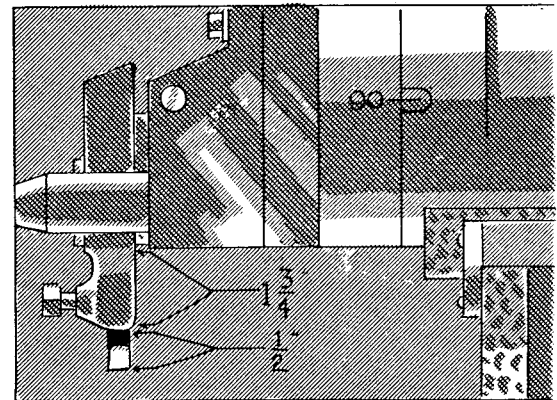

FIG. 468

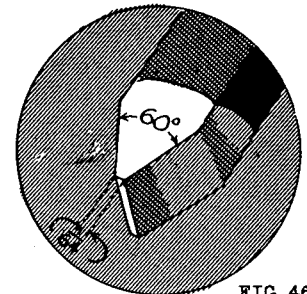

FIG. 469

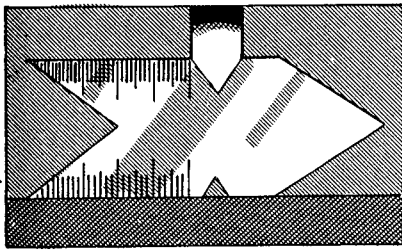

FIG. 470

the tool with the surface of the work (Fig. 470). This, however, as a general rule, is not considered necessary.

7. Tighten the tool-post screw to hold the tool holder securely in place.
8. Tighten the tool-holder set screw to hold the tool securely in the tool holder.
9. Adjust the tool slide until it is about even with the bottom of the tool head (Fig. 468).

ADJUSTING THE SHAPER PRIOR TO OPERATING

1. Adjust the stroke of the ram so that it is 1" longer than the length of the work. Refer to page 79 for adjusting the stroke on the crank shaper, and to page 92 for adjusting the stroke on the hydraulic shaper.
2. Position the ram so that the cutting edge of the tool extends 1/4" beyond the work when the ram is at the extreme forward position. Refer to page 81 for adjusting the ram on the crank shaper, and to page 92 for adjusting the ram on the hydraulic shaper.
3. Adjust the table vertically until the point of the tool is slightly above the level of the surface of the work. Refer to page 77, How to Adjust the Cross Rail.

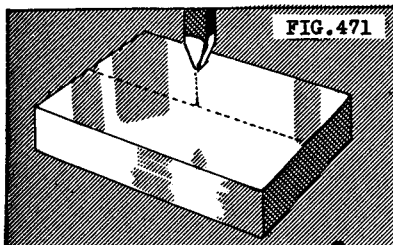

FIG. 471

4. Move the ram until the tool is directly above the top surface of the work (Fig. 471).
5. Move the tool down until the point of the tool touches the top surface of the work (Fig. 472).
6. Set the graduated collar on the down-feed screw at zero.

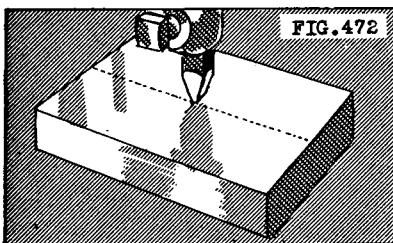

FIG. 472

7. Raise the tool slightly by lifting the clapper box, and, at the same time, move the table until the work is to the left of the tool (Fig. 473).
8. Lower the clapper box.

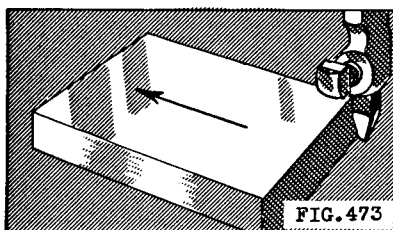

FIG. 473

NOTE: Whenever it is possible, the serrations should be cut to their full depth with one setting of the tool. This is a much simpler process than beginning by cutting the serrations to a partial depth. If the serra-

tions are cut to a partial depth, it becomes necessary to re-set the tool for a deeper cut and to rearrange the feed so that the tool cuts exactly in the path of the first cut.

9. Calculate the speed of the machine for rough planing the surface; then set the speed for one or two speeds slower than would be used for roughing.

NOTE: When the serrations are machined in one cut as suggested in the preceding note, the tool cuts on both sides at the same time. This kind of cutting action requires a slower speed than usual and needs considerably more power than ordinary cuts that are taken with one side of a tool. The speed suggested in step No. 10 should be approximately correct, unless the cut is a heavy one. A good procedure, however, is to start with a slow speed and increase the speed in accordance with the depth of the cut, the power of the machine, and the finish required.

10. Assume that a tool with a 60° point (Fig. 474) is used and that the width of the groove is $3/64$ " wide. Assume also that the distance between the grooves is $1/16$ " (Fig. 475).

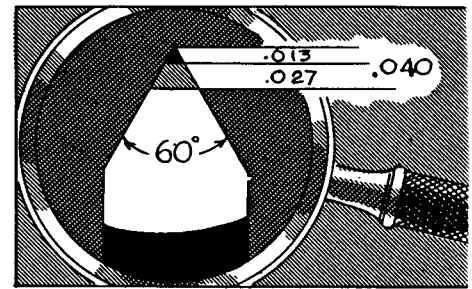

FIG. 474

11. Calculate the distance the tool must be moved down to cut a groove $3/64$ " wide. Since the height of a 60° triangle is .866 of the base, the height of a triangle having a base equal to $3/64$ " is $.866 \times 3/64$ ", or $.866 \times .0468$ ", or $.040$ ".

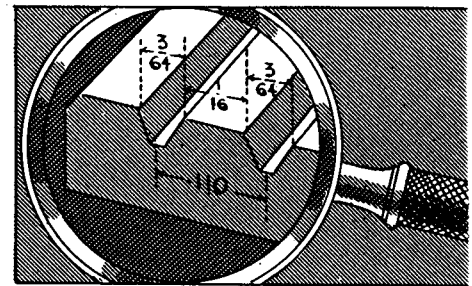

FIG. 475

If the $.013$ " which has been ground off the point of the tool (Fig. 474) is subtracted from the height of the triangle ($.040$ " - $.013$ "), the remainder ($.027$ ") will be the distance the tool must be moved down.

12. Move the tool down for a cut of $.027$ " (Fig. 476).
13. Calculate the distance between the grooves by adding the width of the flat surface to the width of the groove (Fig. 475). For example, $1/16$ " + $3/64$ " = $.0625$ " + $.0468$ " = $.1093$ ", or approximately $.110$ ".
14. Set the feed for $.110$ ", or as near to this as possible. Refer to page 90 for setting

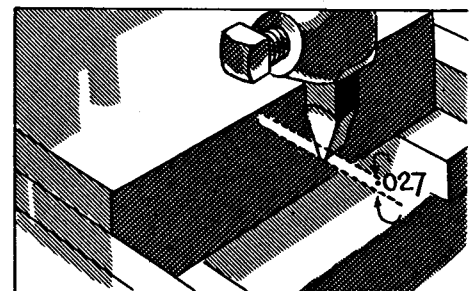

FIG. 476

the feed on the crank shaper, and to page 95 for setting the feed on the hydraulic shaper.

NOTE: On some shapers it may not be possible to set the table feed at exactly .110". As a rule, however, it is not important to have the distance between the grooves particularly accurate, and a few thousandths of an inch more or less will not affect the purpose for which a serrated surface is used. Nevertheless, it is very important that time enough is allowed between the moment when the tool drops clear of the work and the instant the tool again starts to cut, for the work to move over and stop feeding. Unless the adjustment is properly made, the beginning of each groove will be cut at an angle and an unnecessary strain will be placed upon the feeding mechanism.

15. Check the feed as illustrated on page 90.

CAUTION Make certain that the work is moved over far enough to the left so that the tool does not strike the work when the feed is being checked.

16. Make a final check of all adjustments before starting the machine.

TAKING THE FIRST SERIES OF CUTS



Oil the shaper as directed in How to Oil the Shaper, beginning on page 47.

1. Start the machine.
2. Apply with a brush a small amount of lard oil or other suitable coolant to the surface to be cut.
3. Engage the feed.

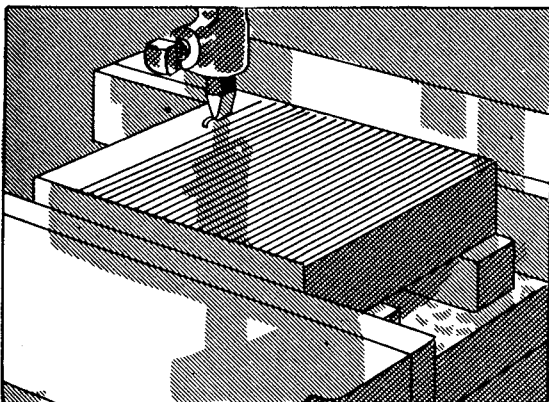

FIG. 477

4. Allow the tool to cut the first series of grooves over the entire surface of the work (Fig. 477).
5. Stop the machine.
6. Raise the clapper box and move the table until the work is again to the left of the tool. The clapper box is raised instead of the tool slide in order to keep the same setting of the tool for the next series of cuts.

TAKING THE SECOND SERIES OF CUTS

1. Set the vise parallel with the direction of the stroke. The vise and the work will then be moved through an angle of 90° and will allow the second series of cuts to be made at an angle of 90° to the first series (Fig. 478).
2. Make any necessary adjustments in the length of the stroke and the position of the ram. This is necessary because the changed position of the vise will affect the position of the work in relation to that of the stroke, and, also, because the width and the length of the work are frequently not the same.
3. Start the machine and engage the feed.
4. Apply a small amount of lard oil or other suitable coolant and allow the tool to cut the second series of grooves. The spaces between the grooves will now be in the form of small squares with the sides of the squares parallel with the sides of the work (Fig. 479).

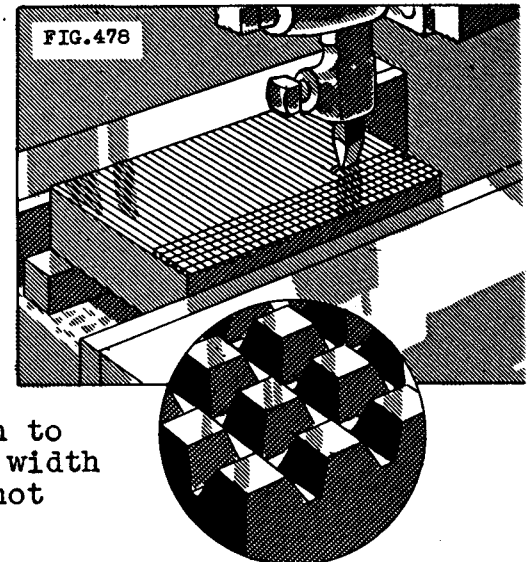

FIG. 479

AT AN ANGLE OTHER THAN 90° TO THE SIDES OF THE WORK

NOTE: The pattern of a serrated surface will vary according to the position in which the vise is set. If the vise is first set at 45° to the left and a series of grooves cut and then set at 45° to the right and a series of grooves cut, the areas between the grooves will be square. The corners of the squares, in this case, will be perpendicular to the sides of the work (Fig. 480), instead of the sides of the squares lying parallel with the sides of the work as in Fig. 478. Again, if the vise is set at an angle other than 45° or 90° to the direction of the stroke and a series of grooves cut at each setting, the areas between the cuts will be diamond-shaped (Fig. 481). The spacing of the grooves also may be regulated by hand. Although this method consumes more time, regulating the distance between the grooves with the aid of the graduated cross-feed dial is sometimes advisable, especially when a second or third cut must be taken.

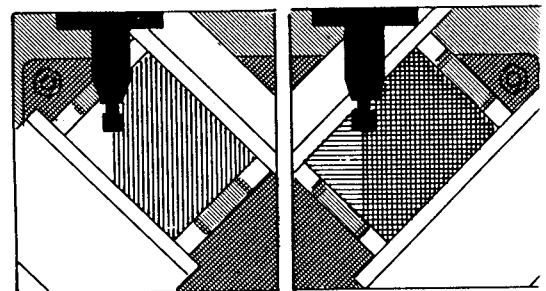

FIG. 480

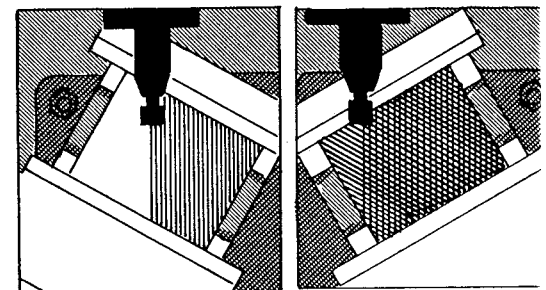

FIG. 481

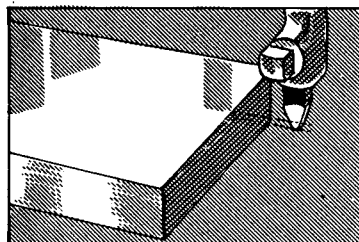

FIG. 482

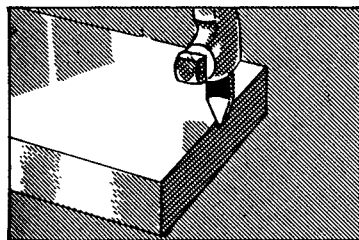

FIG. 483

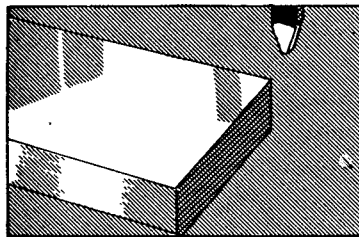

FIG. 484

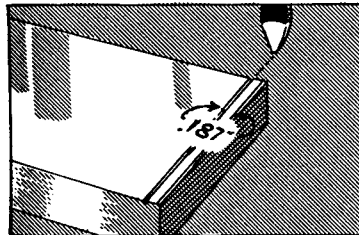

FIG. 485

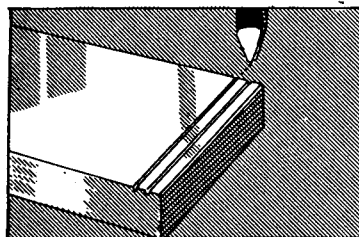

FIG. 486

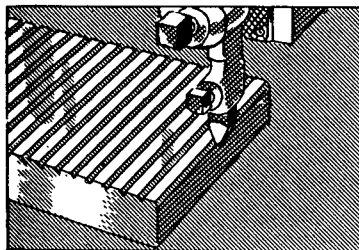

FIG. 487

REGULATING THE DISTANCE BETWEEN THE GROOVES BY USING THE HAND TABLE FEED

1. Be certain that the work is moved to the left of the tool and that the tool is set to the desired depth (Fig. 482).
2. Start the machine.
3. Move the work over until the edge of the tool scrapes the work (Fig. 483).
4. Stop the machine when the tool is at the beginning of the stroke (Fig. 484).
5. Be certain that the back lash is out of the table feed screw and then set the graduated collar at zero.
6. Move the work $.187''$ to the right as shown in Fig. 485. (This is an assumed distance between the grooves.)
7. Apply with a brush a small amount of lard oil or other suitable coolant to the surface to be cut.
8. Start the machine and cut the first groove (Fig. 485).
9. Stop the machine at the beginning of the stroke and move the work to the right another $.187''$ (Fig. 486).
10. Cut the second groove.
11. Repeat instruction No. 9 after each cut until all grooves have been machined.
12. Stop the machine and move the work to the left of the tool.

TAKING A SECOND CUT OVER THE GROOVES BY USING THE HAND TABLE FEED

1. Start the machine and move the table until the tool scrapes the edge of the work. The tool is now set in the same position it occupied when the first cut was taken (Fig. 487).
2. When the tool is at the beginning of the stroke

and the machine is running, move the work a few one-thousandths to take the second cut, and then set the graduated collar at zero.

CAUTION When it is necessary to cut the groove deeper, it is preferable to set the work first to cut the groove a little wider; then, afterwards, move the tool down to cut the groove a little deeper. A tool with tapered sides, if fed vertically downward, has a tendency to build up pressure and produce a rough cut. A smoother cut can be produced by the former method.

3. Stop the machine when the tool is at the beginning of the stroke.
4. Move the work to the right .187", and take the second cut.
5. Repeat the operations No. 3 and No. 4 until a second cut has been taken over the complete series of grooves.
6. Swivel the vise to the desired angle, and cut the second series of grooves, following the same procedure given on the preceding page, Regulating the Distance Between the Grooves by Using the Hand Table Feed.
7. Remove the work from the vise after all operations have been completed.
8. Remove and clean the parallels; remove the tool from the tool holder, and return each tool to its proper place.
9. Brush the chips from the vise and the table, and absorb with waste the coolant from the vise and the table.

HOW TO SHAPE SIMPLE CONTOURS

PROCEDURE

MOUNTING THE VISE AND THE WORK

1. Set the vise at 90° to the direction of the stroke. The zero mark on the vise will coincide with the zero mark on the base.
2. Select suitable parallels so that when the work is placed in the vise and upon the parallels, enough of the work will project above the vise jaws to allow the tool to cut to the contour line (Fig. 488).

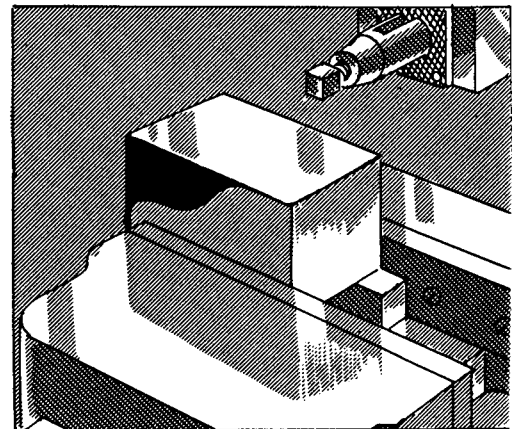
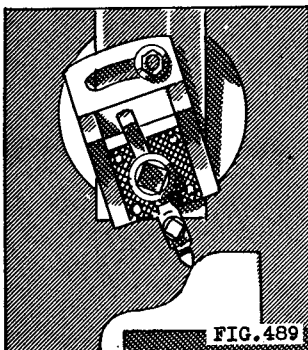

FIG. 488

3. Clean both the vise and the parallels before placing the parallels in the vise.
4. Place strips of paper, if necessary, on the parallels, and then place the work centrally in the vise and upon the parallels.
5. Place protecting strips between the vise jaws and the work, and tighten the work securely in the vise.
6. Tap the work down with a lead or rawhide mallet until the strips of paper are gripped between the top of the parallels and the underside of the work. Refer also to page 191, How to Mount the Work in the Shaper Vise.

SETTING THE TOOL



1. Check the position of the tool head. It should be set in the vertical position.
2. Set the clapper box to the left as in Fig. 489.

NOTE: If the curve of the contour is shallow (Fig. 490), the clapper box should be set in a vertical position. If the curve is steep, the clapper box should be set either to the left or to the right according to the direction in which the curve slopes. For example, the tool is cutting on the left-hand side of the work in Fig. 489 and the clapper box is set to the left.

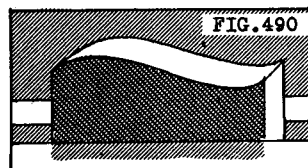

3. Select a tool holder as illustrated on page 155, Fig. 209.

4. Select a tool similar to the one illustrated on page 161, Fig. 228 C.

5. Grind the tool to cut on the left hand-side of the work and have approximately a 1/16" radius on the point.

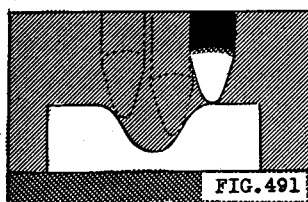

NOTE: A smaller radius on the point of the tool may be necessary to allow the tool to be manipulated around a small or steep radius without the work interfering with the side of the tool. An example of this is shown in Fig. 491. In addition, the operator must estimate the distance the tool must project beyond the end of the tool holder to reach the bottom of the curved surface without the tool holder interfering with the other surfaces of the contour.

6. Allow the tool to extend 3/4" beyond the tool holder if the calculated distance that the tool should project beyond the holder is less than 3/4". This distance is not excessive and, in addi-

tion, it will permit the operator to observe the point of the tool more easily.

7. Place the assembled tool and tool holder in the tool post with the sides of the tool holder parallel with the sides of the clapper box (Fig. 489), and the end of the tool holder projecting 1-3/4" beyond the bottom edge of the clapper box.
8. Tighten the tool-post screw securely.
9. Tighten the tool securely in the tool holder.

ADJUSTING THE SHAPER PRIOR TO OPERATING

1. Move the tool slide down until it projects about 1" beyond the bottom edge of the swivel block (Fig. 492).
2. Move the work over to the right of the tool (Fig. 493).
3. Raise the work and the table until the tool is even with the lowest point of the surface to be cut (Fig. 494). Refer to page 77 for adjusting the table vertically. Make certain that the cross rail is properly clamped and that the table support is properly adjusted.
4. Adjust the stroke of the ram so that it is about 3/4" longer than the length of the cut. Refer to page 79 for adjusting the stroke on the crank shaper and to page 92 for adjusting the stroke on the hydraulic shaper.
5. Adjust the position of the ram so that the cutting edge of the tool is 1/4" beyond the front edge of the work when the ram is in the forward position. Refer to page 81 for adjusting the ram on the crank shaper and to page 92 for adjusting the ram on the hydraulic shaper.
6. Raise the tool slide until the cutting edge of the tool is above the top surface of the work (Fig. 495).
7. Set the speed of the machine for a roughing cut, basing the calculation on the kind of material and the length of the stroke. Refer to page 82, How to Adjust the Speed of the Ram, and to page 94, How to Adjust the Speed of the Ram on the Hydraulic Shaper. (For speed calculations refer to page 303.)

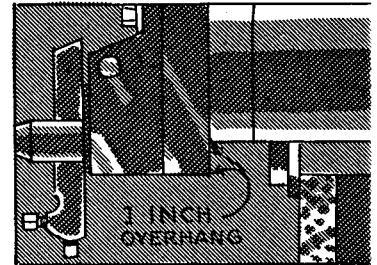

FIG. 492

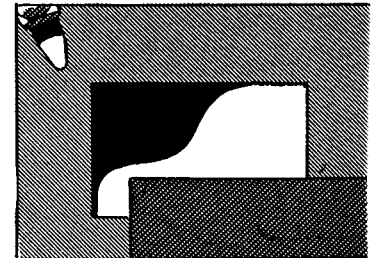

FIG. 493

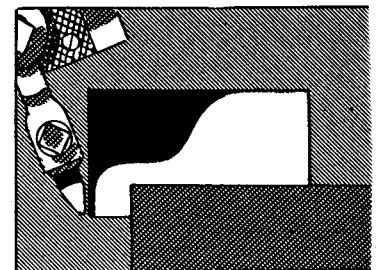

FIG. 494

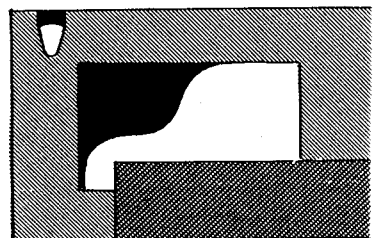

FIG. 495

CAUTION

Check carefully before starting the machine to

see that the speed of the ram is correctly set. Excessive speed and a long stroke may damage the shaper seriously.

CUTTING THE CONTOUR BY USING THE AUTOMATIC TABLE FEED TO CONTROL THE MOVEMENT OF THE WORK AND BY MOVING THE TOOL DOWN BY HAND

NOTE: Sometimes irregularly shaped pieces are cast in the foundry or are forged from steel bars. The purpose of this is to save metal and also the time which would be consumed when the part is being machined. Whenever a casting or a forging is to be machined, usually enough metal is allowed to machine the parts to size and shape. There are times, however, when the part must be shaped from the solid piece. When this is the case, it is frequently necessary to remove a considerable amount of metal.

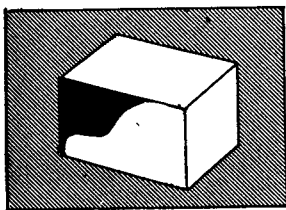

FIG. 496

1. Study the blueprint to visualize the contour to be formed. Figure 496 shows a typical job to be machined from a solid piece.

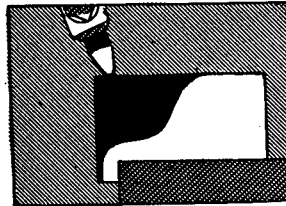

FIG. 497

2. Move the work over and the tool down until the top of the tool touches the work (Fig. 497).

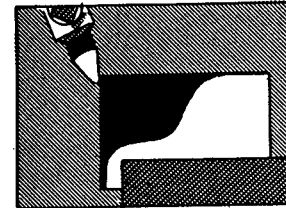

FIG. 498

3. Move the work to the right of the tool; then move the tool down $1/8"$ to $1/4"$ according to the desired depth of cut (Fig. 498).

4. Set the feed for about $.010"$ to $.015"$.

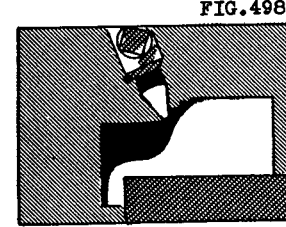

FIG. 499

NOTE: The purpose of roughing out is to remove metal; therefore, the cut should be as deep as possible and the feed should be consistent with the power of the machine to remove metal. The operator should start with a fine feed, and then increase the feed in accordance with the rigidity of the work and the power of the machine to stand the increase.



Oil the shaper as directed in How to Oil the Shaper, beginning on page 47.

5. Start the machine.
6. Engage the feed and allow the tool to make a horizontal cut to within $1/8"$ of the contour line. Then, disengage the feed and move the work by hand until the tool is within $1/16"$ of the contour line (Fig. 499).
7. Move the work to the right of the tool.
8. Take a series of horizontal cuts until the excess material has been removed and the job appears as in Fig. 500.

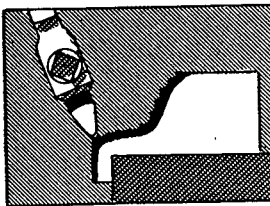
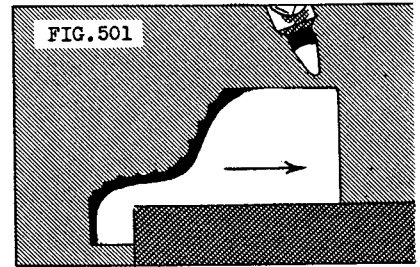

FIG. 500

9. Stop the machine and move the work and the tool until they are in the position shown in Fig. 501.
10. Set the controls (or adjust the feeding mechanism) for the finest feed.
11. Set the direction of the feed so that the work moves to the right, or away from the tool, after each stroke of the ram (Fig. 501).



NOTE: With this arrangement there is less possibility of cutting below the contour line. The operator, of course, must be careful not to feed the tool down too much after each stroke. This is especially important when the curve takes the form of a slight incline. The downward movement of the tool, then, will vary with the slope of the curve, a steeply inclined curve requiring a greater downward movement of the tool for each movement of the work than would a curve with a slight incline.

12. Start the machine.
13. Move the tool down and the work sideways until the tool scrapes at a point $1/32$ " to the left of where the curve drops away from the horizontal line (Fig. 502).
14. Engage the feed, and observe carefully the path of the point of the tool, moving it down so that a machined surface is cut $1/32$ " from, and parallel with, the contour line (Fig. 503).
15. Disengage the feed.
16. Use this semifinish cut as an experimental cut, making the curve as regular and as smooth as possible. (If the part were a casting or a forging, this cut would take the place of the roughing cut.)
17. Raise the tool and move the work to the left (Fig. 504).
18. Move the tool down and the work sideways until the point of the tool scrapes exactly at the place where the curve drops away from the horizontal line (Fig. 505).
19. Engage the feed; then move the tool down to follow the curved line, watching closely and increasing the downward movement of the tool when

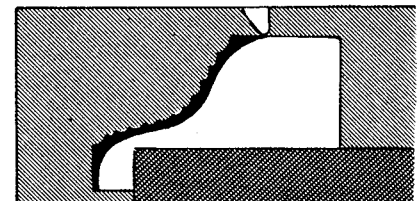

FIG. 502

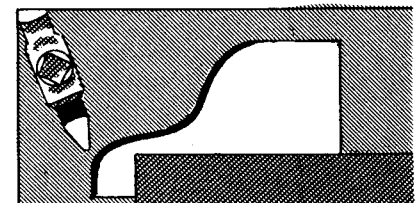

FIG. 503

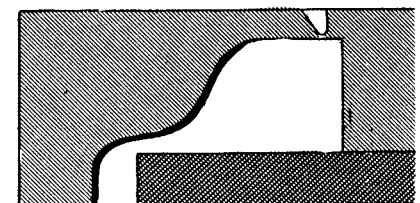

FIG. 504

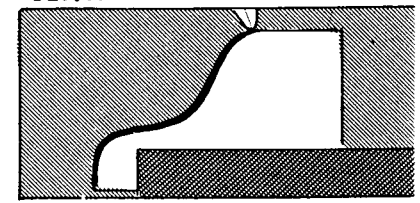
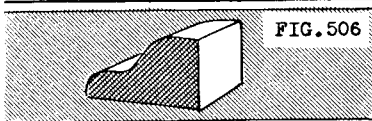

FIG. 505



the curve is steep, and decreasing the downward movement of the tool when the curve is slightly inclined (Fig. 506).

CUTTING A CONTOUR BY CONTROLLING THE CROSS FEED AND THE DOWN FEED BY HAND

NOTE: Cutting a contour by operating the table feed screw with one hand and controlling the downward movement of the tool with the other hand requires a little experience and judgment to produce a smooth, regular curve or contour. Moreover, the relative positions of the down-feed crank and the table feed screw increase slightly the difficulty of operating the hand controls when a contour is being followed. To overcome this, some machines are equipped with a hand-feed control shaft which is situated at the front of the table. When a handcrank is placed on this shaft, the table, with the work attached, can be moved with the left hand, and, at the same time, the tool can be moved with the right hand. This arrangement, in addition to allowing the operator to be in the most natural position to reach the controls, also allows him to observe clearly the progress of the tool in relation to the contour line.

1. Assume that the length of the work is the same as that of the preceding piece, and that the settings of the ram, the stroke, and the speed are identical.
2. Set the clapper box in a vertical position.
3. Set the tool holder in a vertical position.
4. Substitute a left-cut tool for the right-cut tool used in the preceding job. Theoretically, two tools should be used, one to cut on the right side of the curve, and the other to cut on the left side of the curve. Usually, however, one is selected according to the side which requires the most cutting and then used to take a continuous cut around the curve.
5. Allow the tool to project beyond the tool holder about $3/4$ ".
6. Assume that the table is equipped with a front hand-feed table control.
7. Stand at the machine, or sit on a stool at the right-front corner of the table (Fig. 507).

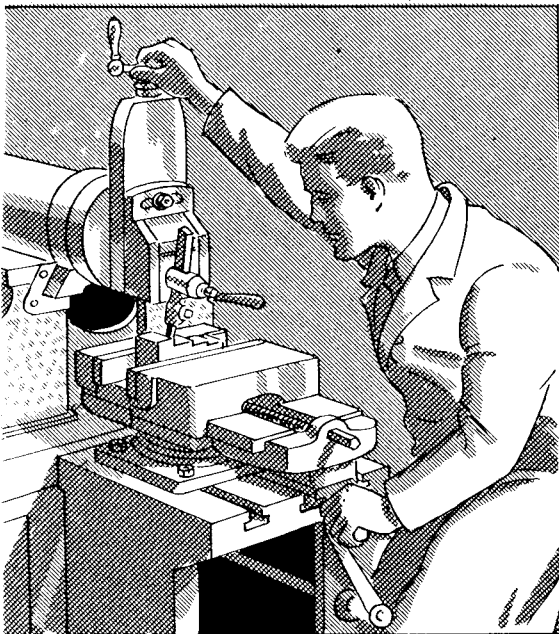

FIG. 507

8. Start the machine.
 9. If the work is a solid piece, it should be partially roughed out first (Fig. 508) by taking a series of horizontal cuts as instructed in step No. 6, page 288.
 10. Stop the machine.
 11. Use the hand control located at the front of the machine for moving the work.
 12. Move the work and the tool until the point of the tool is about $1/16$ " from the place where the curve drops from the horizontal line (Fig. 509).
 13. Start the machine. Move the tool down until it scrapes the surface of the work.
 14. Cut a curved surface by moving the work to the right with the front hand-feed control, and, at the same time, move the tool down for each stroke that the tool makes. When the tool reaches the point where the curve inclines upwards, it must be raised slightly for each stroke of the tool (Fig. 510).
- NOTE:** The distance the work must be moved sideways and the distance the tool must be moved downwards and upwards depend upon the slope of the curve. The ability to judge the correct movement of the work in relation to the changing position of the tool must be acquired by the operator in order to produce a correct and smooth curve.
15. Continue to take a series of cuts, starting at the right side of the work, and manipulating the tool and the work until the metal is cut to within $1/16$ " of the curved line (Fig. 511).
 16. Move the work until the tool is in the position to cut the left-hand side of the contour (Fig. 511).
 17. Move the tool down and the work to the right before each stroke, and take a series of roughing cuts, leaving about $1/16$ " of metal parallel with the curved line (Fig. 512).

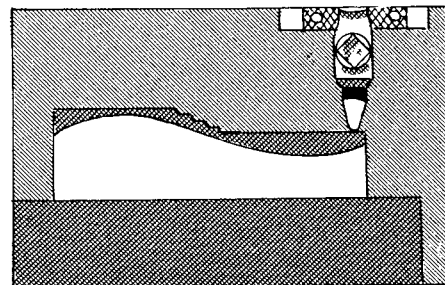

FIG. 508

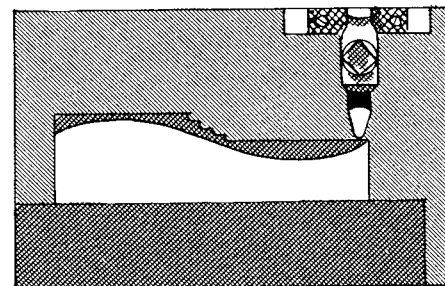

FIG. 509

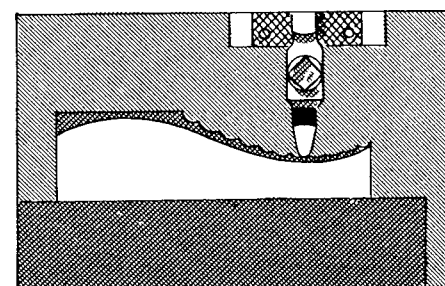

FIG. 510

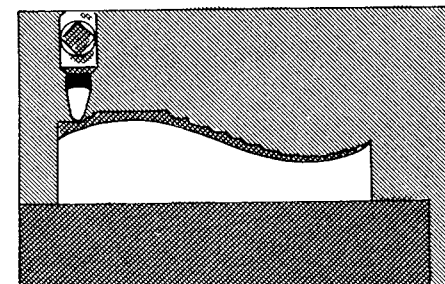

FIG. 511

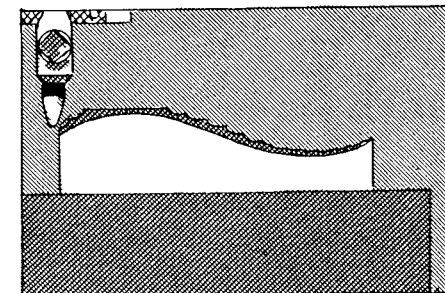

FIG. 512

TAKING THE FINISHING CUT

NOTE: Roughing out the curve may leave the surface rough and irregular. In this case a semifinish cut may be taken within $1/32"$ of the finish line, and then a final cut taken to remove the remaining $1/32"$. The operator may start at the top of the curve and cut down to the lower point. This procedure may be followed whether the curve slopes to the right or to the left. On the other hand, some may prefer to start at the right of the curve and continue around the curve until the cut has been completed.

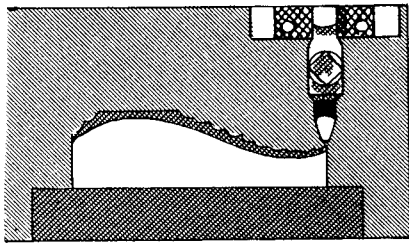

FIG. 513

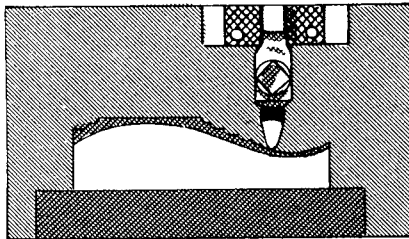

FIG. 514

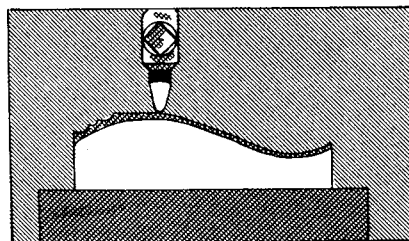

FIG. 515

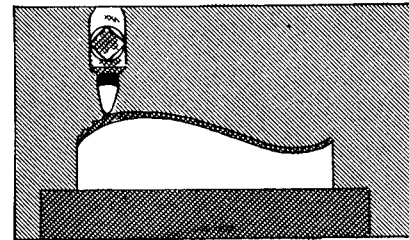

FIG. 516

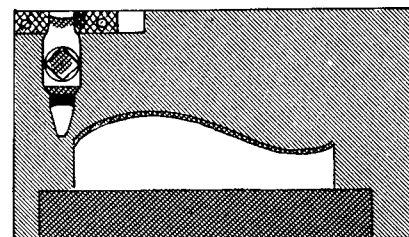

FIG. 517

1. Take a semifinish cut starting at the right of the curve (Fig. 513).
2. Move the tool down and the work to the right, cutting down to the bottom of the curve and machining the surface parallel with, and to within $1/32"$ of, the contour line (Fig. 514).
3. Observe that when the tool has reached the bottom of the curve (Fig. 514), it must be raised while the movement of the work continues toward the right. Observe also that the back lash must be taken out of the down-feed screw before the tool will move upwards. (Refer to page 66.)
4. Continue the process until the tool has reached the top of the curve (Fig. 515).
5. Continue to move the work to the right until the tool is $1/32"$ beyond the point where the contour line drops away from the horizontal line (Fig. 516).
6. Direct the cut downward on the left of the curve (Fig. 517).
7. Take a final cut. Start at the right of the work and manipulate the tool in conjunction with the movement of the work, carefully following the contour line with the point of the tool and making certain that a smooth and even contour is being formed (Fig. 518).

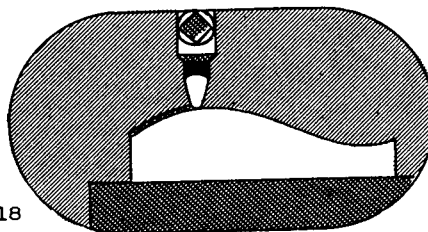
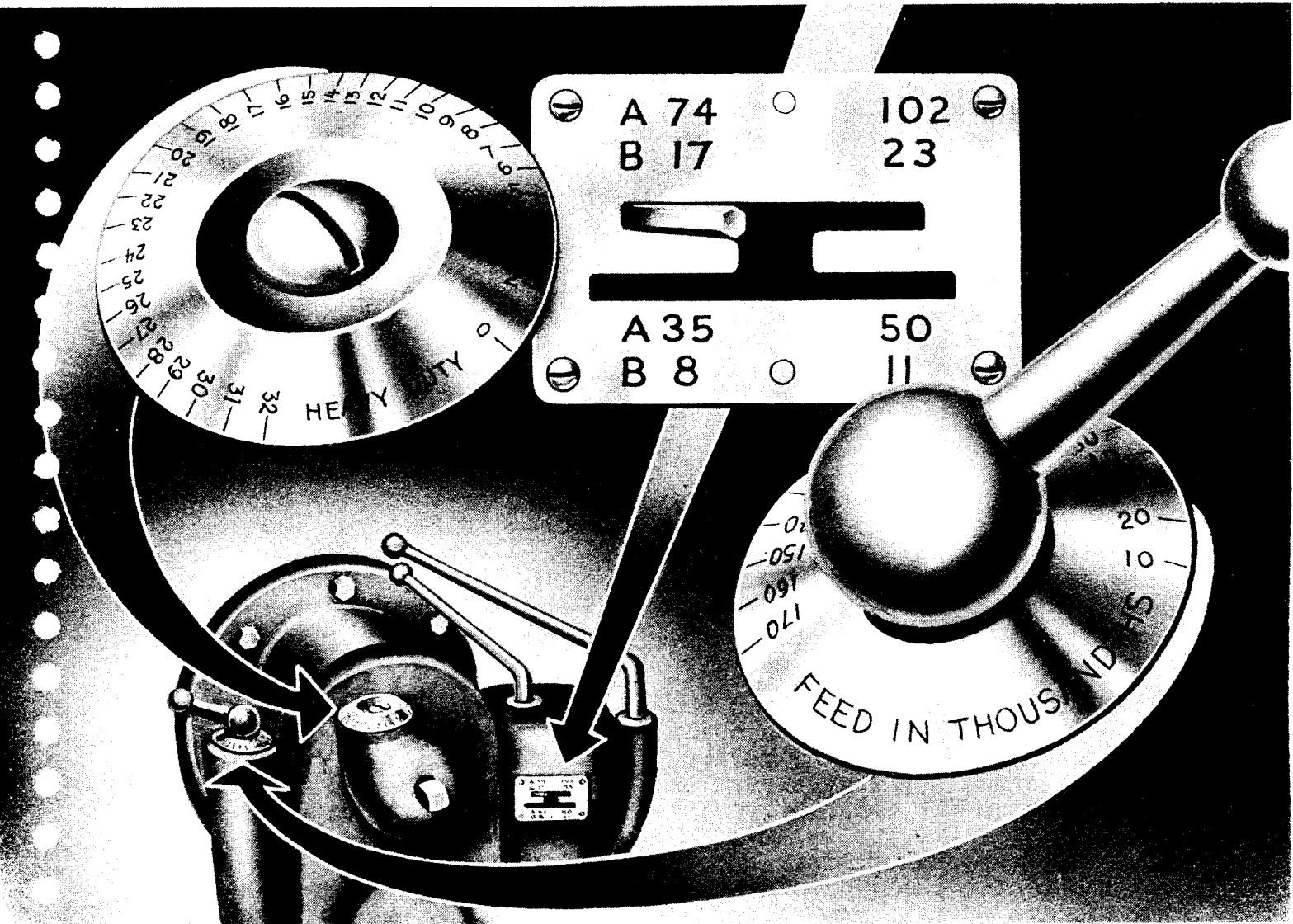

FIG. 518

DESCRIPTION OF SPEEDS & FEEDS

Unit 1-T53(D) Pages 293 to 308



UNIVERSITY OF THE STATE OF NEW YORK
STATE EDUCATION DEPARTMENT
BUREAU OF INDUSTRIAL AND TECHNICAL EDUCATION

DESCRIPTION *of* SPEEDS *and* FEEDS

OBJECTIVES OF UNIT

1. To explain the meaning of speeds and feeds as related to shaper work.
2. To explain the principles governing the selection and the application of shaper speeds and feeds.
3. To explain how shaper speeds and feeds are calculated.

INTRODUCTORY INFORMATION

The rate at which metal can be removed from the surface of the job determines to a considerable extent the amount of time required to produce a finished piece of work in the shaper. Therefore, in order to operate the shaper efficiently, the worker should have an understanding of those factors and conditions which have the greatest influence in establishing, and, at the same time, controlling this rate.

Outstanding among these factors are the following: the cutting speed at which the tool operates, the rate of feed per stroke, and the depth of the cut.

Each of these factors in turn is affected by many conditions, such as the kind of material in the job and the material in the tool. Because of the wide variation in these conditions, it becomes impossible to give a definite rule for determining which combination of these factors — the cutting speed, the rate of feed, and the depth of cut — can be applied to the work, inasmuch as all of these factors must be varied to suit the nature of the job and the operation. The best results in any situation will be obtained only when all the factors involved are properly coordinated.

The beginner will find it helpful to refer to existing and well-established tables of cutting speeds and feeds which are based on average cutting conditions, and to use the recommendations in these tables as a general guide for determining both the amount of metal which can be removed per stroke and the rate of speed best suited to a given cutting material.

The knowledge resulting from judicious use of these tables, combined with the experience gained in applying this information to the job, should enable the operator to distribute his time equitably between the roughing and the finishing cuts to the end that the job may be planed in the shortest time possible, consistent with the amount of metal to be removed and the kind of finish specified.

DESCRIPTION OF THE SHAPER SPEEDS

The term speed, as used in connection with shaper work, has two distinct denotations — one to the speed of the machine, and the other to the average rate of speed at which the cutting tool moves over the surface of the work during the cutting stroke.

The speed of the machine (on the crank shaper) is indicated as the number of cutting strokes made by the ram during one minute of the shaper's operation and is determined by the speed of the main driving gear or bull wheel.

The speed of the cutting tool, more specifically known as the cutting speed, is the average rate of speed the tool attains when the shaper has been adjusted to make a given number of cutting and return strokes of a given length in one minute. The cutting speed is determined by the total distance the tool travels during the cutting strokes made in a minute and by the ratio of cutting-stroke time to return-stroke time.

This information gives us the two factors — time and distance — which are needed for determining the rate of speed; the fractional part of a minute required for the cutting stroke represents the elapsed time; the total length in feet of the cutting strokes made in this period represents the distance.

The speed of the shaper, that is, the number of strokes made by the ram in one minute, remains constant for a given speed of the driving gear, whether the stroke is long or short.

The cutting speed in the crank shaper changes, however, whenever the stroke is made longer or shorter, for distance is one of the factors affecting the rate of speed. Obviously then, if the speed of the machine remains constant, the distance traveled by the tool in one minute increases or decreases in direct proportion to the change in the length of the stroke. For example, when the stroke length is increased from 3" to 6", the resultant cutting speed will be doubled, inasmuch as the tool travels twice as many feet in one minute when it is operating at the longer stroke than it does when it is operating at the shorter one.

Conversely then, if the cutting speed of the tool is to be maintained at the same rate for the six-inch stroke as for the three-inch stroke, it will be necessary to reduce the speed of the shaper

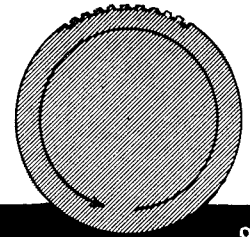

MACHINE SPEED IS DETERMINED BY THE SPEED OF THE MAIN DRIVING GEAR —

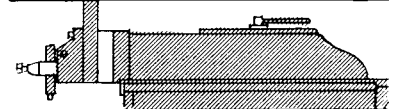

CUTTING SPEED IS THE SPEED OF THE RAM DURING THE CUTTING STROKE —

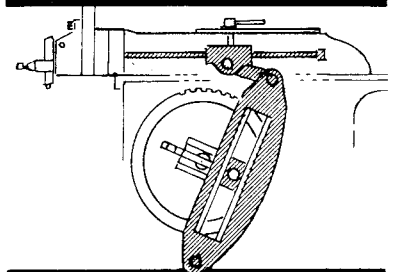

CHANGES IN CUTTING SPEED ARE EFFECTED BY CHANGING THE RATE AND THE AMOUNT OF ROCKER ARM MOVEMENT

— the number of strokes per minute — by one half. Only in this way will the total distance traversed by the tool in one minute be the same for both of these stroke-lengths. Therefore, inasmuch as the cutting speed for a given material remains the same, a change in the length of the stroke must be accompanied by a corresponding change in the speed of the shaper.

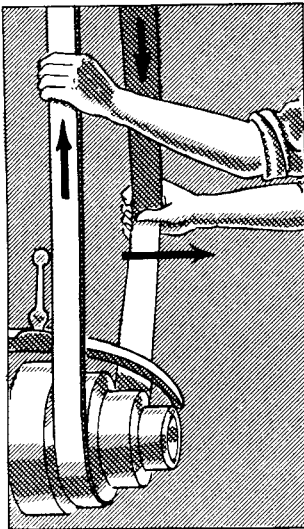

CONE PULLEY

It is for this reason, and for the additional reason that all materials cannot be planed at the same rate of speed (refer to page 308), that the shaper has been provided with several speeds. Then, by changing the speed of the shaper, the cutting speed of the tool can be maintained at established rates even though the length of the stroke and the material in the job may vary considerably.

In the shaper with the cone-pulley drive it is necessary only to change the location of the belt, moving it from one step to another on the pulley in order to change the speed of the machine. The method used to change the speed on a shaper using this type of device has been fully explained on page 83.

In the hydraulically driven shaper the cutting speed for which the machine has been adjusted can be ascertained immediately and at all times, simply by noting the position of the indicator with relation to the figures on the speed-index plate. A change in the cutting speed of a shaper using this type of drive can be made only by changing the position of the speed indicator. The relationship between the position of the speed indicator and the functioning of the flow-control valve to which it is attached has been explained on page 42.

In the shaper with the single-pulley drive, speed changes are effected by changing the positions occupied by the back gears and by the sliding gears located within the transmission case. Eight different speeds are usually provided, four direct speeds and four back-gear speeds.

A sectional view of the transmission on a Cincinnati shaper is shown in Fig. 519. The gear arrangement is typical of that employed in other shapers having a sliding-gear transmission. The eight machine speeds available are indicated as ram strokes per minute on the speed indicator shown on page 293. Any one of the speeds on this plate becomes available when the back gears and the sliding gears have

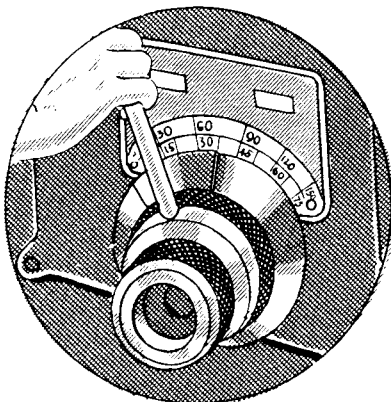

HYDRAULIC DRIVE

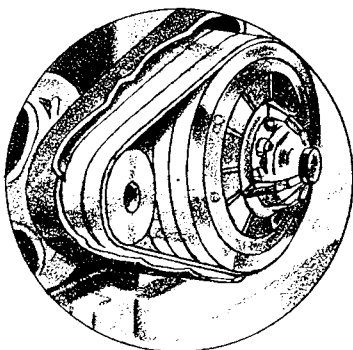

SINGLE PULLEY

been correctly arranged by means of the gear-shift levers. Thus, when the back gears — numbered 9 and 10 — are engaged and occupy the positions shown, any one of the slower series of speeds can be used by shifting one of the sliding gears on the lower shaft into mesh with the gear intended for its use on the shaft above.

For example, when sliding gear number 1 has been shifted to the left so that its teeth mesh with those on gear number 8 just above it, the main drive gear will rotate at its slowest speed, and, consequently, the ram too will make the fewest number of strokes per minute possible (eight per minute) on this shaper.

The shafts and the gears utilized in transmitting power through the transmission for this slow speed, have been shown in black in Fig. 520. By means of this gear arrangement, power from the drive pulley is transmitted first to gear number 1; then it is transmitted successively through the gears numbered 8, 9, and 10, and by their connecting shafts; and then, finally, the pinion sets the main drive gear in motion.

It should be noted that in each pair of gears, the driver — gear number 1, gear number 9, and the pinion — is the smaller with the result that a reduction in speed occurs in each set of gears in use. This accounts for the reduction in speed from approximately 500 R.P.M. of the drive pulley to 8 R.P.M. of the crank gear and 8 strokes per minute of the ram. Additional and progressively faster speeds in the back-gear series can be obtained by shifting, in the order mentioned, gear number 2, number 3, or number 4, into mesh with the proper one on the shaft above.

Any one of the four faster speeds indicated on the speed plate becomes available when the back gears have been disengaged and motion is transmitted directly through the transmission.

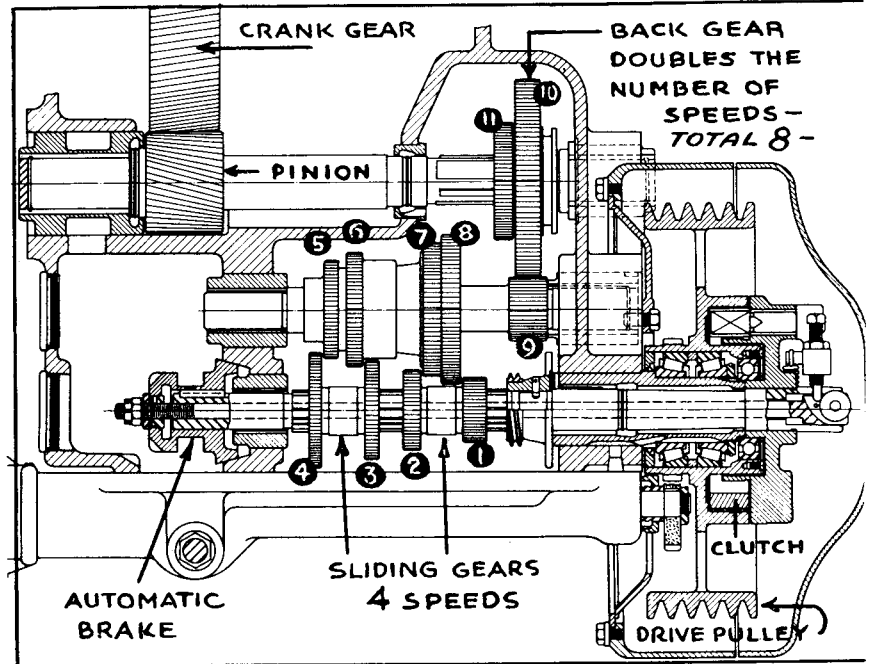

FIG. 519

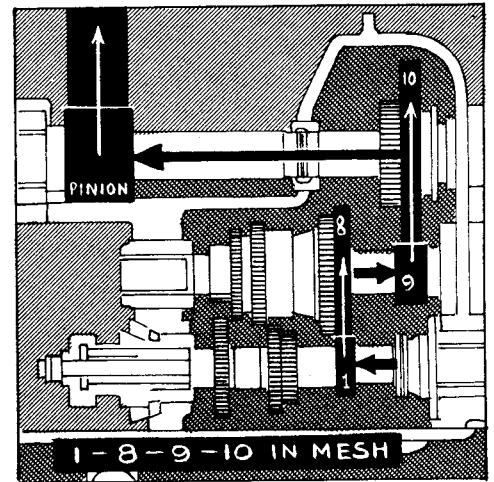

FIG. 520

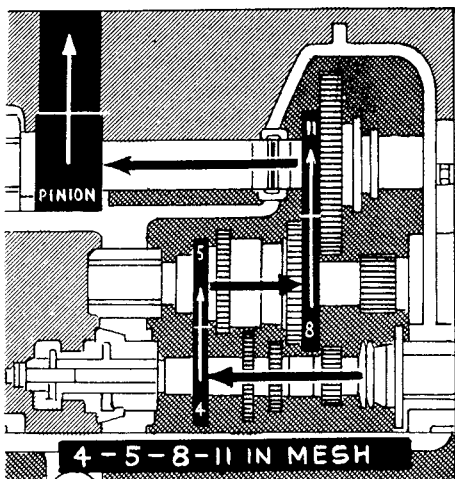

FIG. 521

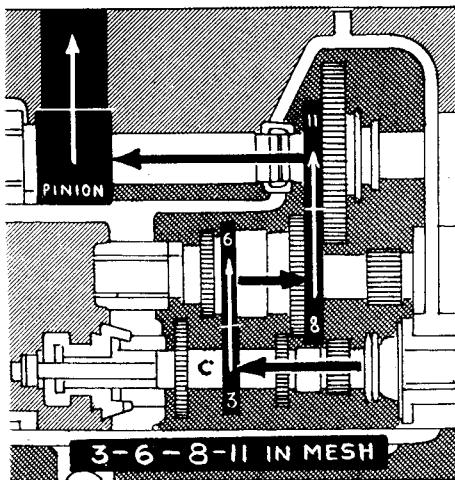

FIG. 522

The change from back-gear drive to direct drive is made by moving the back-gear lever from its position B to its position A, causing the gears numbered 10 and 11 to be shifted to the left. As a result of this shift, gear number 8 now turns the pinion shaft directly through gear number 11, instead of indirectly through the back gears as formerly.

For example, when sliding gear number 4 on the lower shaft has been moved to the right and meshed with gear number 5 on the shaft above, the main drive gear will make the greatest number of revolutions per minute possible on this machine and, as a result, the ram will make the greatest number of strokes per minute possible (102 strokes per minute).

The gears and shafts used in this example of direct drive have been shown in black in Fig. 521. Power applied to the drive pulley is now transmitted through the clutch to gear number 4 on the lower shaft and successively to the gears numbered 5, 8, and 11, and then, finally, by means of the pinion, to the main drive gear. It should be noted that now, the driving gears numbered 4 and 8 are larger than the gears numbered 5 and 11 which they drive. Consequently, there is an increase in speed in both pairs of gears, for the relative speed of a pair of gears is directly proportional to their diameters.

Another example of direct drive which produces a somewhat slower speed of the shaper has been indicated in Fig. 522. Now, cluster gear C has been shifted to the left instead of to the right. With this gear arrangement, gear number 3 on the drive shaft transmits power to gear number 6 on the countershaft and then to the main drive gear as in Fig. 521. Inasmuch as the difference in the diameters of this pair of gears is not as great as that of gears number 4 and number 5, which were utilized in Fig. 521, the main drive gear will not make as many revolutions per minute as before, and, consequently, the ram will make fewer strokes per minute also.

It follows then, that still slower speeds will result when a smaller drive gear, number 2 or number 1, is shifted into mesh with the proper gear on the countershaft.

The four speeds indicated opposite B on the speed chart on page 293 are made available by first engaging the back gears and then shifting the proper sliding gear as for the direct series of speeds.

DESCRIPTION OF CUTTING SPEED

Cutting speed for the shaper has been defined as the rate of speed attained by the tool as a result of its making a given number of strokes of a given length in one minute.

This speed is the average rate and not a constant rate at which the tool travels over the work's surface, for it takes into account the slower movement of the tool at the beginning and at the end of each stroke. Moreover, owing to the construction of the driving mechanism in the crank shaper, the tool does not operate at a constant rate at any time during the entire stroke of the ram. Instead, the cutting speed changes continually, for the tool travels at a slow rate near the beginning of the stroke when the rocker arm is in an angular position, and at a rate which increases steadily as the tool nears the center of the cut and the rocker arm moves from its angular to a vertical position. Then, as the tool passes the center of the cut and continues to move toward the end of the cutting stroke, its speed again diminishes gradually, for after passing the center of the stroke, the rocker arm gradually assumes an angular position similar to the one it occupied at the beginning of the stroke. (Refer to Fig. 523.)

An even greater variation in speed occurs during the return stroke than occurs during the cutting stroke. At this time the crank pin which causes the oscillating movement in the rocker arm, rotates nearest the pivot shaft where a given movement of the crank pin produces the greatest movement of the rocker arm as has been explained in the Description of the Quick Return Mechanism on page 19.

The diagram of a typical full stroke of the ram (Fig. 523) indicates graphically (by the use of lines) the relative rates of speed attained by the cutting tool at various points during each forward and each return stroke. It also illustrates why the cutting speed must be given as the average speed.

The horizontal line in the velocity diagram represents the length of the ram stroke. The vertical lines extending upward from the horizontal

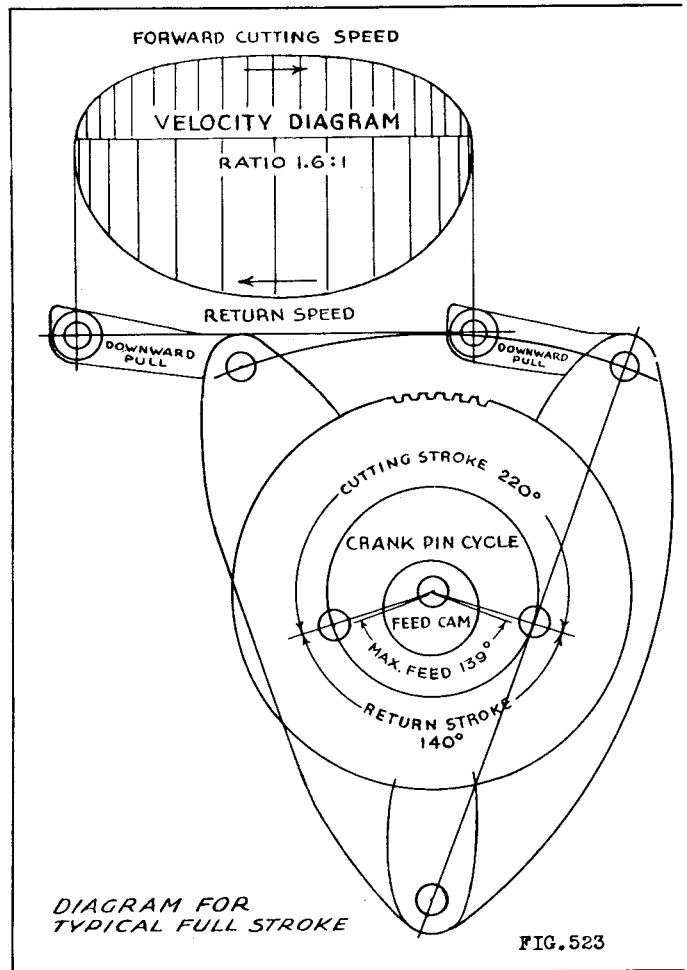

line represent the cutting speeds attained at various points during the forward stroke. At this time the crank pin rotates in a clockwise direction through that portion of its cycle marked "cutting stroke" and moves the rocker arm from its position at the left in the diagram to that shown at the right.

The vertical lines extending downward represent the various rates of speed attained by the tool during the return stroke. Now the crank pin, still rotating in a clockwise direction and in that portion of its cycle marked "return stroke," moves the rocker arm back to its original position at the left. At this point the crank pin has made one complete revolution, and, as a result, the ram has made a forward and a return stroke.

Above the horizontal line, the curve formed when the outer ends of the vertical lines are connected, indicates the fluctuation which occurs in the cutting speed from end to end of the cutting stroke; below the horizontal line, the curved line, more pronounced than the one above, indicates the greater fluctuation in speed occurring during the return stroke. As a consequence of this variation, the only speed which can be given is an average of that attained at the various points during the stroke.

In addition to indicating the speed of the ram by their lengths, the vertical lines in the velocity diagram indicate by their spacing the relative distance which the ram is caused to move for every 10° rotation of the crank pin throughout one complete cycle. Thus, the 22 spaces above the horizontal line represent the 220° through which the crank pin rotates during the cutting stroke while the rocker arm moves from the position shown at the left to the one at the right in Fig. 523. The 14 spaces below the line represent the 140° through which the crank pin rotates while returning the rocker arm to the position it occupies at the beginning of the stroke.

It should be noted in this connection that the vertical lines are most closely spaced near the ends of the stroke. At this time the rocker arm is in an angular position wherein a 10° rotary movement of the crank pin produces a smaller amount of movement in the rocker arm (and in the ram) than does a similar movement of the crank pin when the rocker arm occupies a more nearly vertical position.

Inasmuch as 220° of the crank-pin cycle are utilized while the tool is making the cutting stroke and only 140° remain in which it can make the return stroke which is of equal length, the tool must travel at a proportionately faster rate during the return stroke than it does during the cutting stroke.

HOW TO DERIVE AND USE THE FORMULAS FOR CALCULATING THE CUTTING SPEED FOR THE SHAPER

The method of calculating the cutting speed for the shaper differs

somewhat from that used for calculating the cutting speed for machines in which the tool cuts continuously. To begin with, the shaper tool cuts only during the forward stroke and, moreover, the return stroke is faster than the cutting stroke.

It is necessary, first of all, therefore, to ascertain the ratio of the cutting-stroke time to that of the return-stroke time, in order that a proportionate amount of the total time required to make one full stroke can be assigned to each phase of the stroke.

Since the crank pin makes a constant number of revolutions per minute, the time required to make the cut is to the time required to make the return stroke as the distance traveled by the crank pin during the cutting stroke is to the distance traveled by the crank pin during the return stroke. In Fig. 523 the distance traveled by the crank pin is given as 220° and 140° respectively for the cutting and for the return strokes. The relationship these numbers bear to each other, therefore, establishes the ratio of the cutting-stroke time to the return-stroke time and can be found in the following manner.

Distance traveled by the crank pin during the cutting stroke = 220°
Distance traveled by the crank pin during the return stroke = 140°

Let the missing term be expressed by X.
Then,

$$\begin{aligned} \text{Let } X &= \text{the ratio} \\ 220 : 140 &= X : 1 \\ 140 X &= 220 \\ X &= 1.57 \end{aligned}$$

The ratio can then be expressed as

$$220 : 140 = 1.5 : 1 \text{ or } 3 : 2.$$

This means that the ratio of the cutting-stroke time to the return-stroke time is as 3 : 2, and that it takes approximately $1\frac{1}{2}$ times as long to make a cutting stroke as it does to make a return stroke.

The sum of the terms of this ratio (3 : 2) equals 5 and represents the time required to make one complete stroke; $\frac{3}{5}$ of this time equals the time of the cutting stroke and the remainder, $\frac{2}{5}$, equals the time of the return stroke.

Two factors necessary for calculating the cutting speed, represented as C.S. in the formula, are usually known or else they can be ascertained very readily by referring to the proper dials on the shaper. These factors are

1. the number of the strokes per minute, represented by N;
2. the length of the stroke in inches, represented by L.

The product of these factors, $N \times L$, equals the number of inches cut during one minute of shaper operation. Since the cutting speed is expressed in feet, this product must be multiplied by $1/12$ to reduce it to feet cut per minute. The partial formula thus far reads

$$N \times L \times \frac{1}{12}$$

As explained previously, the actual time for cutting this distance is $3/5$ of a minute. Therefore, in order to determine the cutting speed, the formula above must be divided by $3/5$ or multiplied, instead, by the inverted fraction $5/3$, for distance divided by time equals rate. The completed formula for finding the cutting speed then appears as

$$C.S. = N \times L \times \frac{1}{12} \times \frac{5}{3}$$

Since it is necessary in each problem to multiply by $1/12$ to reduce to feet, the distance traveled by the tool during the cutting stroke, and then by $5/3$ to establish the rate of speed, this formula can be simplified somewhat by multiplying these factors ($1/12 \times 5/3$) and using the result as a constant in the formula.

Thus, $\frac{1}{12} \times \frac{5}{3} = \frac{5}{36} = .14$. The formula in its simplified form will

then read

$$C.S. = .14 N L$$

Below is an illustration of the use of the formula in solving a problem.

PROBLEM: What is the cutting speed of the tool when the shaper makes 60 strokes per minute, 12 inches long?

FORMULA: $C.S. = N \times L \times \frac{1}{12} \times \frac{5}{3}$

SUBSTITUTION: $C.S. = 60 \times 12 \times \frac{1}{12} \times \frac{5}{3}$

CANCELLATION: $C.S. = \overset{20}{\cancel{60}} \times \overset{1}{\cancel{12}} \times \frac{1}{\cancel{12}} \times \frac{5}{\cancel{3}} = 100$ feet per minute. Ans.

The solution of the same problem by means of the simplified formula is shown below.

FORMULA: $C.S. = .14 N L$

SUBSTITUTION: $C.S. = .14 \times 60 \times 12 = 100$ feet per minute. Ans.

HOW TO DERIVE AND USE THE FORMULA FOR DETERMINING THE NUMBER OF STROKES PER MINUTE REQUIRED FOR OBTAINING A SPECIFIED CUTTING SPEED

Two factors must be known in order to determine the number of strokes per minute the shaper is to make. They are

1. the required cutting speed of the tool, represented by C.S.;
2. the length of the ram stroke in inches, represented by L.

The cutting speed recommended for planing various materials can be obtained from the table of Allowable Cutting Speeds — Feet Per Minute on page 308, and the length of the stroke can be ascertained by consulting the proper dial on the shaper. When these factors are known, the number of strokes per minute, represented by N, can be found by transposing (changing about the terms) the cutting speed formula.

FORMULA: $C.S. = .14 N L$

TRANSPOSITION: $N = \frac{C.S.}{L \times .14} = \frac{C.S. \times 1.00}{L \times .14}$

CANCELLATION: $\frac{C.S. \times \overset{7.2}{\cancel{1.00}}}{L \times \underset{1}{\cancel{.14}}} = \frac{C.S. \times 7}{L}$

An example showing the use of the formula in solving a problem follows:

PROBLEM: How many strokes per minute are required to take a roughing cut on cast iron with a high-speed steel tool with a stroke 12" long? Note: In the table on page 308, a cutting speed of 60 feet per minute is recommended for roughing cuts on cast iron.

FORMULA: $N = \frac{C.S. \times 7}{L}$

SUBSTITUTION: $N = \frac{60 \times 7}{12}$

CANCELLATION: $N = \frac{\overset{5}{\cancel{60}} \times 7}{\underset{1}{\cancel{12}}} = 35$ strokes per minute. Ans.

The above calculations need not be made when a hydraulically driven shaper similar to the one shown on page 33 is being operated. In a machine of this type the range of cutting speeds in feet per minute

has been indicated on the speed-index chart which forms a part of the flow-control and overload-relief valve. The particular speed in use is determined by the position the speed indicator occupies in relation to this chart, for it regulates the control valve. Therefore, once the cutting speed has been determined on the basis of the material in the job and the material in the tool, and after this speed has been set by the adjustment of the speed indicator to the desired figure on the speed-index chart, the cutting speed will not change even though the stroke is made longer or shorter.

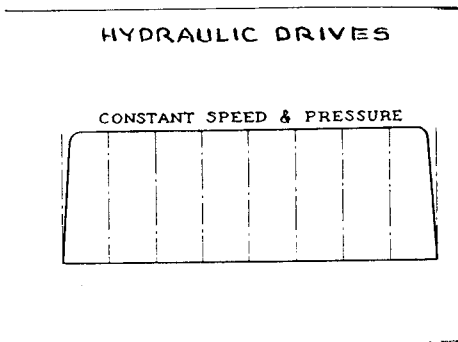

FIG. 524

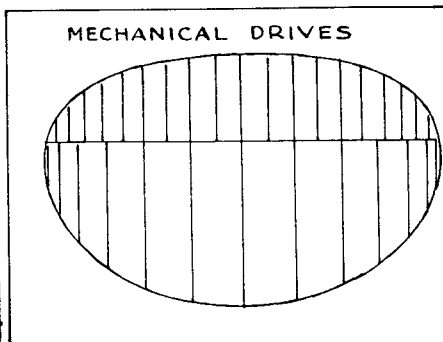
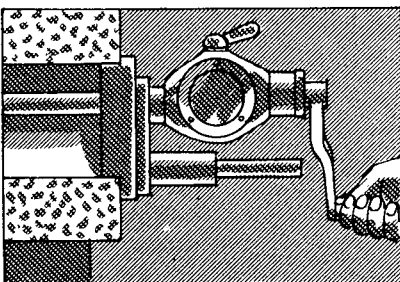
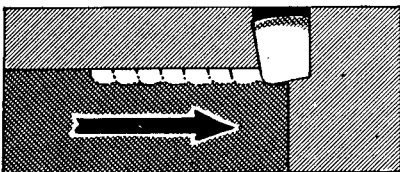

FIG. 525

The speed of the hydraulic shaper during its cutting stroke has been shown graphically in Fig. 524. A comparison of this diagram with the velocity diagram for the crank shaper (Fig. 525) reveals considerable difference in their shapes. This dissimilarity is due to the difference between

the driving mechanisms of these two types of shapers, for the curve in each diagram is formed by connecting vertical lines representing the cutting speed of the ram at various points during the cutting stroke. In the hydraulic shaper, for example, the ram attains its speed almost immediately after beginning the cut and continues at a constant rate throughout almost the entire stroke as the upper straight line in the diagram above indicates; but in the crank shaper the ram speed changes continually as revealed by the upper curved line in Fig. 525.



DESCRIPTION OF THE SHAPER FEED

When considered in connection with horizontal cuts, the feed on the shaper is defined as the distance that the work is moved toward the cutting tool for each forward stroke of the ram. For example, a .020" feed means that the table is moved toward the tool twenty thousandths of an inch each time the ram makes a cutting stroke. The feeding may be done either by hand or by an automatic feeding mechanism which functions in a manner quite similar to that of one of the mechanisms described in the section beginning on page 23, the type varying according to the make and age of the shaper.

The amount of feed used is an important factor in determining the time required to complete the work. Furthermore, this factor has considerable influence on the finish obtained. If the feed is doubled, that is, if the work is fed over .040" per stroke instead of .020", the time required to take a cut from a surface of a given width is cut in half, providing the speed of the shaper remains constant. Obviously then, a coarse feed should be used whenever practicable on account of the saving in time effected.

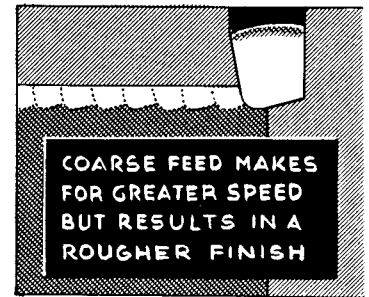

The selection of the rate of feed, however, is governed by certain equally important factors that limit the amount of feed per stroke which can be used, for the pressure of the cut increases as the rate of feed increases. The design of the job which is to be planed is one of the factors which influences the rate of feed, for if its shape prohibits its being clamped securely either in the vise or onto the table, a coarse feed cannot be used at this time.

The character of the metal also influences the rate of feed which can be used to best advantage on the job. For example, if the material in the job is soft cast iron or steel, and the job can be clamped solidly in the machine in one way or another, a reasonably coarse rate of feed can be used; on the other hand, if the metal is somewhat harder, or if it is tough, a reduced rate of feed will be advisable because of the inability of the tool, and sometimes the machine also, to withstand the strains resulting from cutting these materials using a coarse feed. Some grades of tool steel, for instance, offer considerable resistance to being cut, and, consequently, when this type of material is being planed, a fine feed will be required.

From the foregoing it might be assumed that a coarse feed can be used for planing some of the nonferrous metals, such as brass and aluminum and their alloys, inasmuch as metals of this type offer comparatively little resistance to cutting. Actually, however, this is not the case, for since the thick chips resulting from a coarse feed do not pass freely from the tool, the surface of the work becomes torn and rough.

The depth of the cut, too, affects the rate of feed which can be used. A limited amount of metal, for example, can be removed in a shaper of a given size, providing the job is capable of withstanding the pressure exerted upon it by the cutting tool. This amount of metal can be removed in one of two ways, either by taking a heavy cut with a fine feed, or by taking a lighter cut with a coarser feed per stroke. The use of a very coarse feed is objectionable, frequently, because of the rough surface condition resulting from a feed of this kind. Then, instead of the usual single finishing cut, several may be necessary in order to remove the tool marks left by the roughing tool used with a very coarse feed.

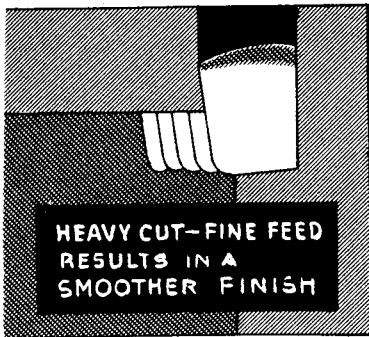

Usually, therefore, a heavy cut with a finer feed is preferred to the lighter cut and the coarser feed. The recommended procedure is to set a rate of feed which will result in the kind of finish desired, and then to take the greatest depth of cut possible, giving consideration, also, to the rigidity of the setup and the nature of the material in the job.

Finally, the rate of feed is influenced also by the angle the cutting edge of the tool makes with the surface being planed, in that the thickness of the chip is affected by this angle. For example, throughout the illustrations in Fig. 526, the depth of the cut D and the rate of feed F are the same, but because of the difference in the angle at which the cutting edge approaches the cut, the chip varies in thickness T , the chip becoming thinner as the angle is increased.

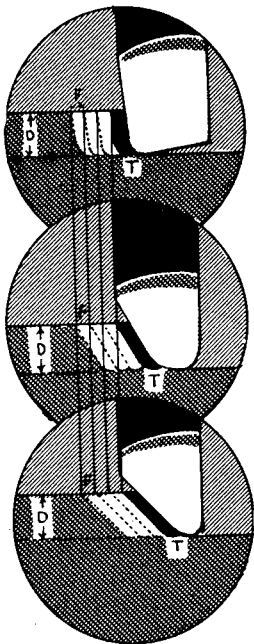

FIG. 526

Best results in roughing out ferrous metals have been obtained when the cutting edge of the tool assumes an angle of about 20° with the work's surface. This angular approach of the cutting edge to the work can be obtained in two ways: (1) by the preferred method of setting the tool holder vertically in the tool post and then grinding the tool bit to the desired angle; or (2) by the method wherein the position of the tool holder in the tool post is changed to obtain the desired 20° setting of the cutting edge. The last method, however, becomes objectionable when it is necessary to set the tool holder at such an angle that it points into the cut; for if the tool holder shifts from this position, as it is likely to do from cutting pressure, the cut will become deeper than intended.

HOW TO CALCULATE THE TIME REQUIRED TO TAKE A CUT IN THE SHAPER

The time required to take a cut depends on three factors, namely: the number of strokes the tool makes per minute; the rate of feed per stroke of the tool; and, finally, the width of the surface which is to be planed.

The values assigned to these factors differ for each job and therefore must be determined before a computation of cutting time can be made. For example, the number of strokes per minute is dependent on the cutting speed which it is advisable to use, the rate of feed selected is dependent on the factors discussed on the pages immediately preceding this section, and, obviously, the width of the cut is dependent on the width of the surface to be planed.

When the values for these three factors have been established, the time required for taking a cut can be determined by dividing the width of the surface in inches by the product of the feed per stroke and the number of strokes per minute.

A formula for this computation follows:

$$T = \frac{W}{F \times N}$$

in which

- T = the time required to make the cut
- W = the width of the surface to be planed
- F = the feed in inches per stroke
- N = the number of strokes per minute.

HOW TO USE THE FORMULA FOR CALCULATING THE TIME REQUIRED TO MAKE A CUT

PROBLEM: How much time will be required to take a cut from a cast-iron plate 7" wide and 12" long, with a high-speed steel tool and a feed of .020" per stroke? Note: Refer to the problem on page 303 for calculating the number of strokes per minute.

FORMULA:

$$T = \frac{W}{F \times N}$$

SUBSTITUTION:

$$T = \frac{7}{.02 \times 35}$$

CANCELLATION:

$$T = \frac{7 \cdot 2}{.02 \times \underset{1}{\cancel{35}}} = \frac{.2}{.02} = 10$$

ANSWER:

10 minutes .

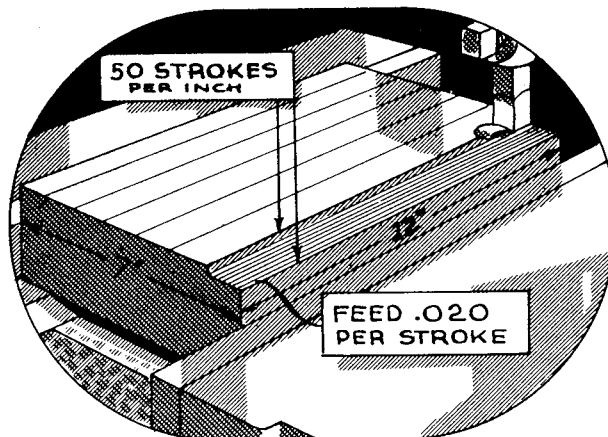

ALLOWABLE CUTTING SPEEDS - FEET PER MINUTE

Material to be Planed	<u>MATERIAL IN TOOL</u>			
	High-Speed Tool Steel		Carbon Tool Steel	
	Cutting Speed in Feet Per Minute			
	Roughing Cut	Finishing Cut *	Roughing Cut	Finishing Cut *
Aluminum	150	Max. Safe Speed	100	150
Brass	150	Max. Safe Speed	100	150
Bronze (Hard)	60	100	30	50
Cast Iron	60	100	30	50
Machine Steel	80	120	40	60
Annealed Tool Steel	50	60	25	35

* These cutting speeds are not recommended for wide finishing tools.

S E L E C T E D R E F E R E N C E S

Burghardt, Henry D.
Machine Tool Operation,
Part II

Colvin & Stanley
American Machinists' Handbook

DESCRIPTION OF BENCH *or* FLOOR GRINDER

DESCRIPTION OF GRINDING WHEELS

Unit 1-T54 Parts I and II Pages 309 to 314

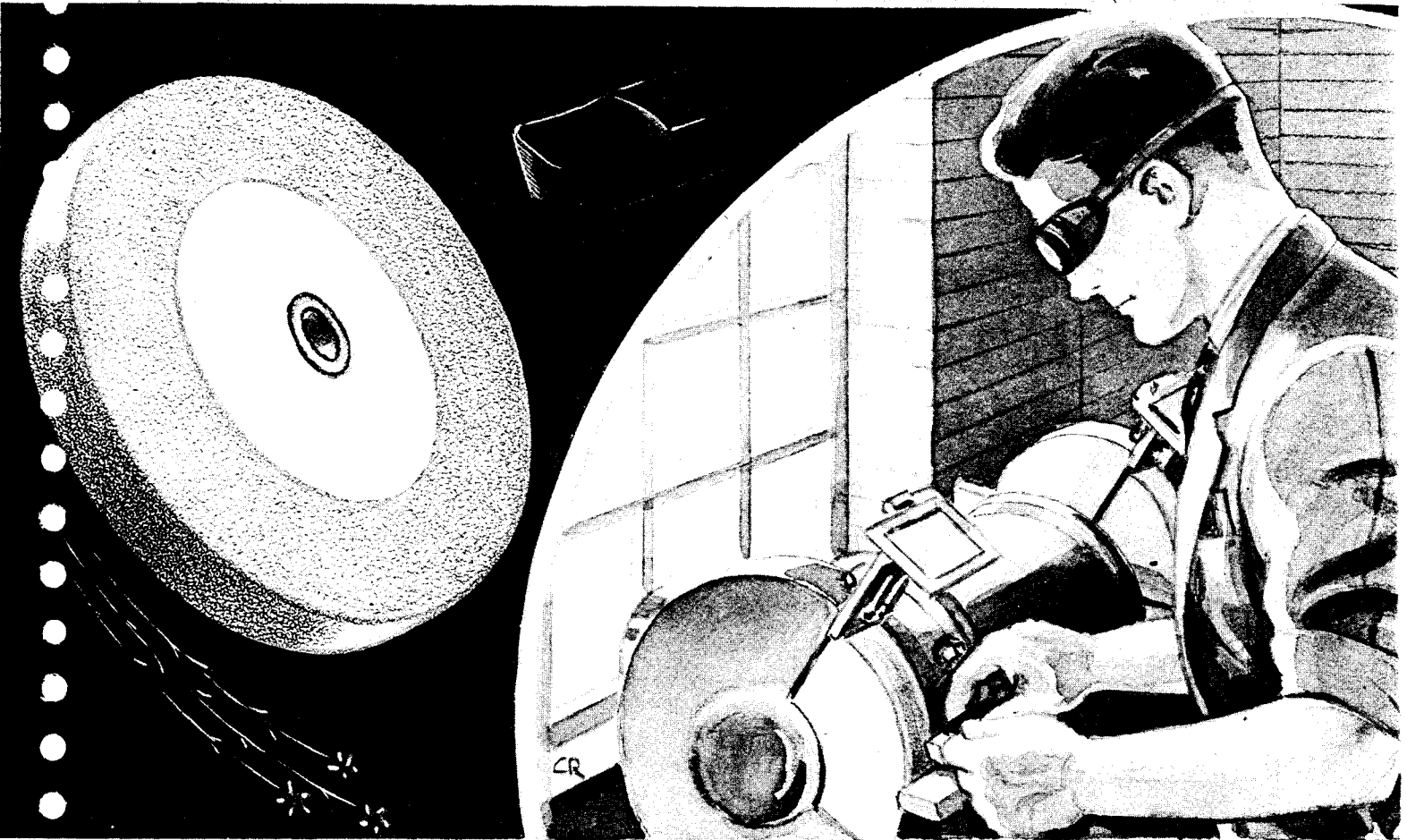

UNIVERSITY OF THE STATE OF NEW YORK
STATE EDUCATION DEPARTMENT
BUREAU OF INDUSTRIAL AND TECHNICAL EDUCATION

DESCRIPTION of BENCH or FLOOR GRINDER

OBJECTIVES OF UNIT

1. To give a general description of the principal parts of the bench or floor grinder.
2. To give a description of the grinding wheels used on the bench or floor grinder.

INTRODUCTORY INFORMATION

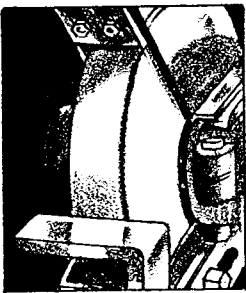

Bench and floor grinders are especially designed to hold and revolve the grinding wheel and at the same time to steady the hand of the operator and give support to the tool while it is being ground.

Inasmuch as the grinder operates at high speed, usually between 5000 feet and 6000 feet per minute, various protective devices are provided to guard the worker against wheel breakage and flying particles caused by the grinding process.

These protecting devices include wheel enclosures, or guards, safety-glass eye shields, and, frequently, an exhaust system to remove fine particles of abrasives from the air in the vicinity of the wheel.

The grinding wheel which is mounted on the grinder is made up of small, hard, irregularly shaped granular particles with sharp edges, called the abrasive, and a substance which holds the particles together, called the bond.

The ingredients are thoroughly mixed and then placed in molds of various shapes and sizes to form wheels. Subsequently the wheels are subjected to a process of fusing the bonding material in order to hold the particles together and to withstand the stresses due to the grinding procedure. Afterwards, the wheels are trued in a lathe, and the arbor hole is bushed with lead. Finally, the wheels are tested and graded.

DESCRIPTION OF THE BENCH OR FLOOR GRINDER

The bench grinder (Fig. 527) is designed primarily to be used on a bench. The same grinder, however, can be mounted on a pedestal and converted into a floor type (Fig. 528). The grinder, then, can be placed in any convenient location where it will be accessible easily from all sides. Although tool grinders of the belt-driven style are still in use, they are being replaced rapidly by

the ball-bearing, motor-driven type.

Grinders may be purchased with motors of 1/4 HP upwards, but for general tool grinding the machine should be equipped with at least a 1 HP motor. The motor shaft, or spindle, extends beyond each side of the motor. It is upon these extensions that the two wheels are mounted.

The wheels are held between two flanged collars, or discs, (Fig. 529) with blotting-paper washers between the sides of the wheel and the collars. The blotting-paper washers will absorb any unevenness in the wheel and will lessen the danger of setting up strains which might cause the wheel to crack. The grinder spindle has a right-hand thread on the right end and a left-hand thread on the other. When a grinder is viewed from the right-hand end (Fig. 531), the small arrow on the spindle indicates the direction that the spindle is turning; the middle arrow indicates the direction that the nut must be turned to tighten the wheel to the spindle. When the tool is being ground, the pressure against the grinding wheel tends to force the wheel in the direction of the third arrow. Since the wheel and the nut have a tendency to turn in the same direction, any movement of the wheel will turn the nut also and will cause it to tighten.

Conversely, when the grinder is observed from the left side, the shaft turns in a clockwise direction (Fig. 530). Since the pressure of the grinding process tends to turn the wheel counterclockwise, as indicated by the outer arrow, the nut also will be turned in the same direction. If this end of

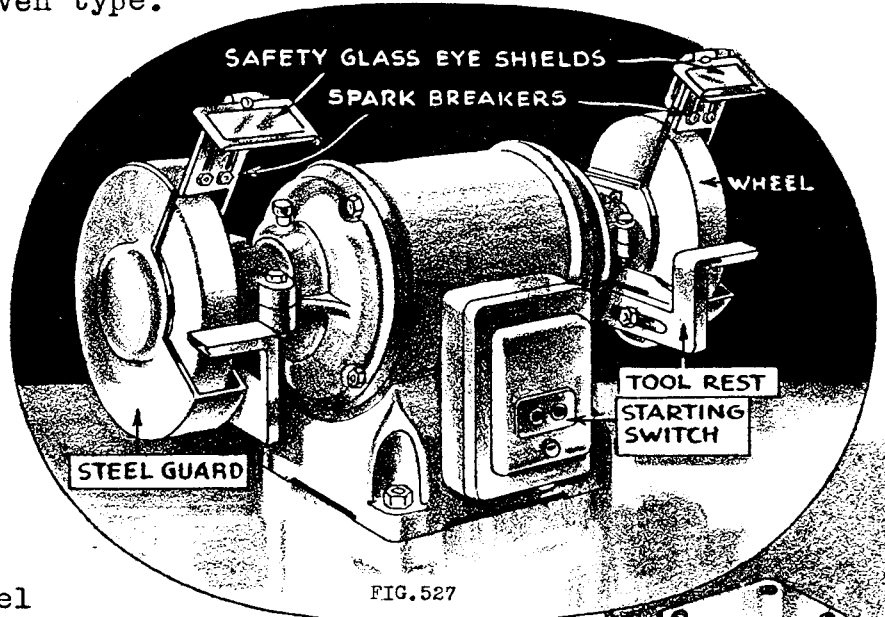

FIG. 527

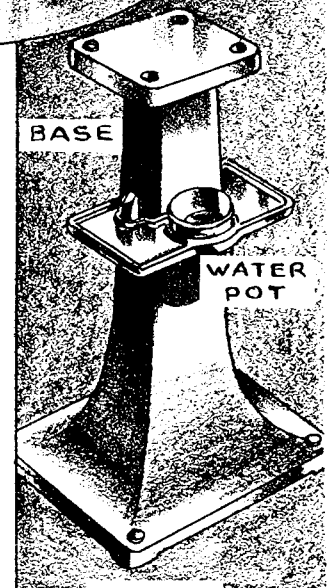

FIG. 528

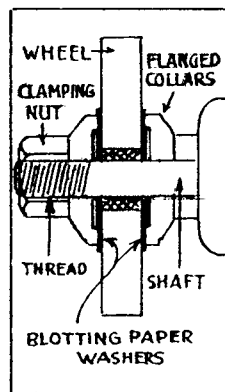

FIG. 529

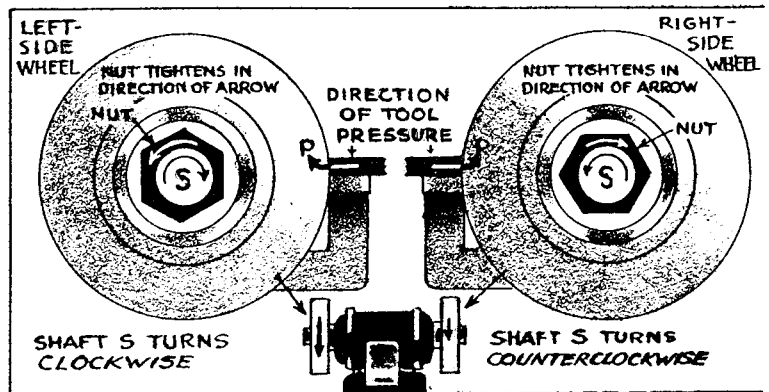
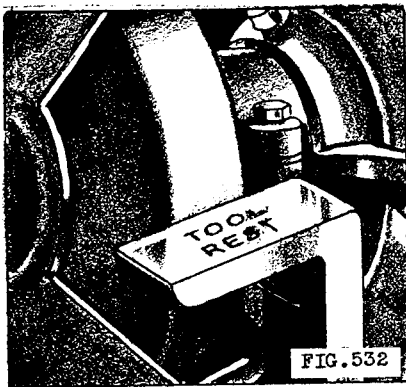

FIG. 530

FIG. 531

the shaft had a right-hand thread, the nut would loosen, and the wheel would slip on the shaft. The thread and the nut on the left-hand side of the grinder are always left-handed, thus causing the nut to tighten if the wheel should slip or turn slightly.

The wheels are encased in steel or semisteel guards (Fig. 527) as a protection against flying particles or larger pieces which might injure the operator if the wheel should break. An opening in the front of the guard is provided to allow the tool to be held against the wheel. The sides of the guards are hinged or detachable to allow the wheels to be mounted or removed from the spindle. The newer grinder guards are equipped with outlets to which an exhaust system is attached. The exhaust draws the grinder dust away from the wheel, thereby safeguarding the health of the operator and protecting other equipment. Exhaust systems which can be attached to individual pedestal grinders are now available from many of the leading manufacturers of grinding equipment.



A tool rest (Fig. 532) is provided for each wheel so that tools may be steadied while they are being ground. Most tool rests are adjustable for height and may be moved in toward the spindle to compensate for the wear of the wheel.

The operator's eyes are protected against flying abrasive materials and ground metal by safety-glass eye shields (Fig. 527). Adjustable spark breakers (Fig. 527) which are attached to the upper portion of the guard, provide additional protection for the operator's eyes. They prevent particles from being carried around by the wheel and from rebounding from the tool rest. These also may be adjusted to compensate for the wear of the wheel.

A water pot is usually furnished on pedestal grinders so that the operator can plunge the tool into the water when it becomes heated by grinding. Safe, handy, and quick methods of starting and stopping the grinder are essential as safety factors. These requirements are best satisfied by providing the grinder with a push-button or toggle switch conveniently located near the hand of the operator.

DESCRIPTION of GRINDING WHEELS •

The grinding wheel must be considered as an integral part of the bench and floor grinder. The development of the modern grinding wheel is the inevitable result of the demand for wheels which are uniform in quality and capable of grinding the harder metals and alloys which have been introduced during the last few decades.

This development was made possible by the discovery and use of artificial abrasives to replace the natural abrasives which previously had been used in wheel manufacture.

Natural abrasives, such as emery and corundum, are the products of the forces of nature. They are not uniform in character and contain a considerable percentage of impurities. These impurities impair the cutting qualities of the wheel. The artificial abrasives, on the other hand, are produced by subjecting certain minerals, such as bauxite, coke, etc., to intense electrical heat. This process yields a substance of uniform character and quality which, when crushed, produces a tough, hard, sharp abrasive grain.

Artificial abrasives are grouped under two general headings: aluminum oxide and silicon carbide. Those wheels that are made with an aluminum oxide abrasive are best suited for grinding hardened steels, high-speed steels, and other materials of high tensile strength; the silicon carbide wheels are used for grinding material of low tensile strength, such as cast iron, aluminum, etc.

The grain or grit of a wheel denotes the size of the particles of abrasive. The grain size is determined by the smallest size screen through which the grains will pass. For example, if a screen has sixty openings per linear inch, the grain number would be sixty.

The bond is the material used to bind the abrasive particles together in the form of a wheel. There are several types of bonding material, each having its own particular characteristics. One method of bonding, known as the vitrified process, is generally employed in the manufacture of wheels used on the bench and floor grinder. The bond, in this process, is a clay which, when fused or vitrified in a kiln, or oven, is converted into a glasslike substance which holds the abrasive grains securely together.

The grade of a grinding wheel is the degree of strength with which the particles of abrasives are held together. Wheels may be grouped in three general classifications: hard, medium, and soft. These terms do not refer to the degree of hardness of the abrasive itself, but to the holding power, or strength of the bond which holds the abrasive together. In other words, if the particles are easily dislodged from the face, the wheel is termed "soft"; in contrast, those wheels which hold the particles more securely are termed "hard."

Manufacturers designate the grade of grinding wheels by using letters or numbers, and sometimes a combination of both, to designate the grades. Unfortunately, there is, at present, no absolute grading system for grinding wheels. The alphabetical method of designating the grades is used by the majority of manufacturers for vitrified bonds, but, even then, some use the letters at the beginning of the alphabet to indicate wheels of the hardest grade, while

others use the beginning letters of the alphabet to designate wheels of the softest grade. The American Standard System of using the letters "S," "M," and "H" in combination with figures is expected, however, eventually to replace the alphabetical system.

The following is an example of two grading systems used by two leading manufacturers. The comparisons are approximate.

<u>Hard Range</u>	<u>Medium Range</u>	<u>Soft Range</u>
D E F G H	I J K L M N O	P R S T U V W
Z W U T S R Q	P O N M L K J	I H G F

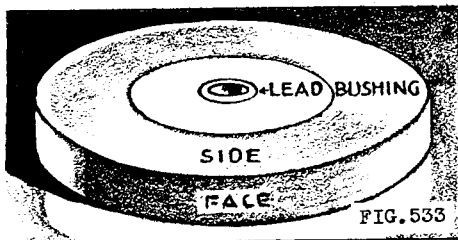

The shape of the wheel used on the bench or floor grinder is the straight or disk wheel (Fig. 533). There are eight other standard shapes used in industrial grinding operations, but the disk wheel with straight sides is the one most commonly used when single-point tools are being ground.

Wheels recommended for bench or floor grinders are as follows:

Carborundum Company	Norton Company
Coarse-36-J-30 Aloxite (Vitrified)	Roughing 36 O Alundum (Vitrified)
Range 24 to 40 Grit, H to K grade.	Finishing 60 N Alundum (Vitrified)
Fine-60-J-30 Aloxite (Vitrified)	
Range 50 to 80 Grit, J to M grade.	

Wheels of similar grade made by other manufacturers can be selected from a comparative wheel-grade chart. These charts indicate the system of marking used by various manufacturers and give an approximate comparison of the wheel grades of one manufacturer with those of another.

When in doubt, however, regarding the selection of the wheel or its performance, write to the manufacturer. The data should include the speed of the wheel, its size and shape, the nature of the work, and the material to be ground. The manufacturer may be able to suggest some slight change either in the conditions under which the wheel is used or in the selection of the wheel itself, that will greatly increase the efficiency and the life of the wheel.

S E L E C T E D R E F E R E N C E S

Abrasive Company	Grinding Wheel Data Book
Carborundum Company	Carborundum Grinding Bulletins
Norton Company	Lectures on Abrasives and Grinding

HOW TO USE *the* BENCH *or* FLOOR GRINDER

HOW TO GRIND SHAPER TOOLS

Unit 1-P54 Parts I and II Pages 315 to 326

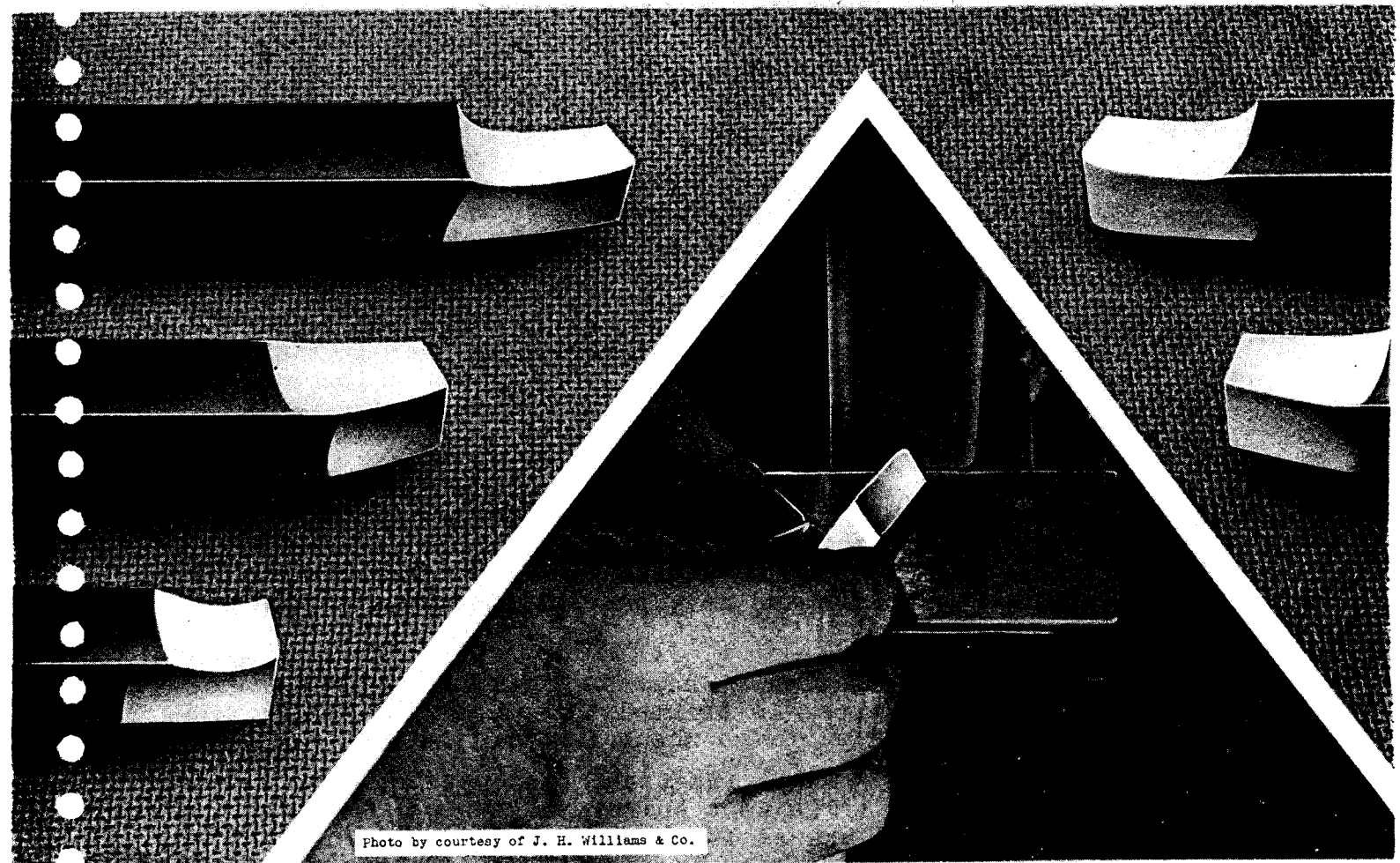

UNIVERSITY OF THE STATE OF NEW YORK
STATE EDUCATION DEPARTMENT
BUREAU OF INDUSTRIAL AND TECHNICAL EDUCATION

HOW TO USE *the* BENCH *or* FLOOR GRINDER

OBJECTIVES OF UNIT

1. To explain how to mount a grinding wheel.
2. To explain how to make preliminary adjustments prior to grinding.
3. To explain how to dress a wheel.
4. To explain how to grind shaper tools.

INTRODUCTORY INFORMATION

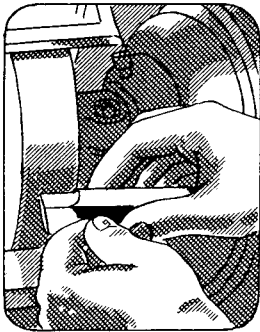

Bench and floor grinders are used for all kinds of general grinding and for the sharpening of drills, chisels, tool bits, and other small tools.

This grinding process is often called "off-hand grinding" to distinguish it from cutter- and tool-grinding processes in which the cutter is held in some type of holding device.

All wheels must be tested for cracks and closely inspected before they are placed on the spindle. Great care should be exercised when the wheel is being mounted in order to prevent setting up any undue strains which might cause the wheel to break. A wheel which breaks in use will probably damage the machine and may, possibly, seriously injure the operator.

After a wheel has been mounted, it must be "trued." Truing means, in this case, that the wheel is trimmed to run concentrically on its axis and that the face of the wheel is straightened.

In addition to having the wheel run true, the operator must see that the face of the wheel is kept sharp and in good condition. A wheel that is properly graded for a particular job is considered self-sharpening; that is, when the particles of abrasive that are present on the face of the wheel become dulled, they are dislodged by the pressure of work against the wheel, thereby exposing the new and sharp particles of abrasive. These conditions, however, are not always obtainable when a wheel is used for general grinding purposes. Under these conditions the abrasive particles are often retained on the face of the wheel after they have become dulled, or "glazed," and, in addition, the open spaces between the particles may become "loaded" with small pieces of metal. When a wheel is in this condition, it requires "dressing."

"Dressing" is the process of restoring the sharpness of the grinding wheel by breaking away the dulled abrasive crystals or by removing the glazed, or loaded, surface of the wheel with a dressing tool. Dressing should not be confused with truing which means shaping or trimming the wheel to run true. When a wheel on a bench or pedestal grinder is being dressed, the dressing tool is held against the wheel by hand. The hand steadies the dressing tool but does not hold it in a fixed relation to the wheel. On the other hand, when the wheel is being trued, the dressing tool must be held and guided in a fixed relation to the wheel.

In our school machine shops, truing the wheel is usually considered the responsibility of the instructor, and, therefore, the instructions for truing the wheel are not given in this unit.

Tool-bit grinding is an operation which requires considerable skill and experience. The function of the cutting tool is to remove metal. The tool should do this easily, at maximum speed and feed, and should retain its cutting qualities as long as possible. To enable the tool to do this efficiently, its angles and clearances must be correctly and skillfully ground.

The underlying principles governing the shapes, the cutting angles, and the clearances of tools are described in Unit 1-T52(C), page 157. These principles not only should be thoroughly understood but the angles and shapes also should be clearly visualized so that the operator can grind tools without the aid of too many gages.

Tools should be roughed out on a coarse wheel and finish ground on a fine wheel. When, however, the tool is required to produce a smooth surface, a further refinement of the cutting edge, termed "stoning," is necessary. "Stoning" is accomplished by hand smoothing the cutting edge of the tool with a fine abrasive stone until the grinding marks of the wheel have been eliminated. A tool ground and then stoned in this manner will, under proper operating conditions, produce an excellent finish.

TOOLS AND EQUIPMENT

Bench or Floor Grinder	Cleaning Cloth
Grinding Wheels	Safety Goggles
Scraper	Grease
Wheel Dressers	Oil Can
Necessary Wrenches	Cloth or Glove
Protractor	Left-Cut Roughing Tool for Steel
Bevel Gage	Grooving or Cutting-Off Tool
Surface Plate	Four 3/8" Tool Bits
Parallel Block	Side-Cutting and Squaring Tool
Sharpening Stone	Round-Nosed Tool for Bronze or Brass

PROCEDURE

HOW TO MOUNT AND DISMOUNT A GRINDING WHEEL

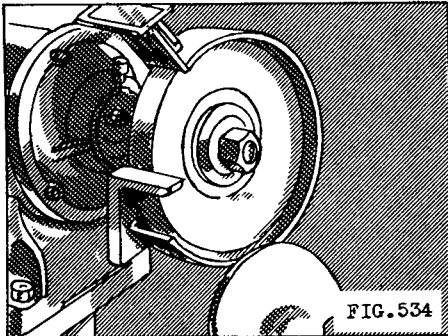

FIG. 534

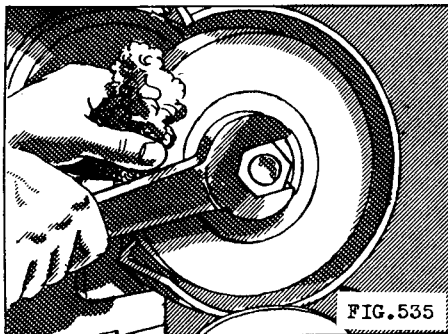

FIG. 535

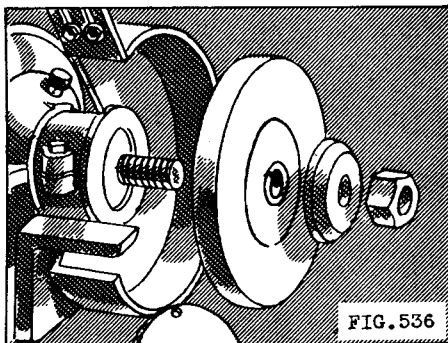

FIG. 536

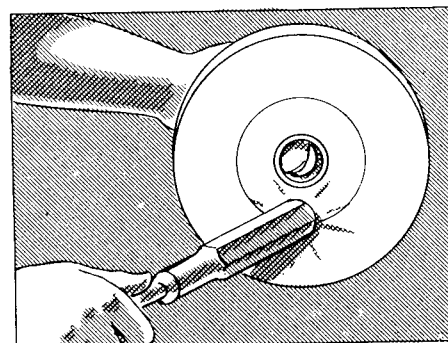

FIG. 537

1. Remove or open the sides of the wheel guards.
2. Hold the rim of the wheel, which is located on the right-hand side of the grinder, with the left hand. Use a cloth or glove to protect the hand and to prevent the wheel from slipping (Fig. 535).
3. Loosen the nut by giving the wrench a sharp jerk downwards. If the nut fails to loosen or the wheel slips in the hand, place a wooden wedge between the wheel and the tool rest to hold the wheel securely. The nut then can be loosened easily (Fig. 535). Loosen the nut on the left-hand end of the spindle. Follow the directions given in the two preceding steps, with the exception that the right hand will be used to hold the wheel and the left hand will be used to pull on the wrench.
4. Remove the nuts, the outer flanges, and the wheels from both ends of the wheel spindle. Wheels of this type have blotting-paper washers glued to the sides (Fig. 536).
5. Place the dismantled wheels in a storage rack. Loosen the nuts or screws which hold the tool rests and the spark breakers, and move them out as far as possible from the center of the spindle.
6. Select a wheel to suit the style and size of the grinder, and of the correct grade, grit, bond, and grain. (Refer also to page 314.)
7. Suspend the wheel on the finger (Fig. 537), or, if the wheel is too heavy to hold on the finger, place it on the bench and tap it gently with a light wrench or the handle of a screw driver. If the wheel is sound, it will emit a clear ring; if the sound is flat, examine the wheel for cracks.
8. Inspect the wheel carefully for flaws and imperfections.
9. Be certain that the lead bushing is tight in

the wheel and that the ends of the bushing do not project beyond the sides of the wheel. This may be easily checked by placing a scale across the ends of the bushing (Fig. 538).

10. Clean the spindle and the face of the flange. The flange which is next to the bearing is a snug fit and keyed on the spindle. Therefore its removal from the spindle is not necessary (Fig. 539).
11. Slip the wheel over the spindle. If the spindle has a tendency to bind in the lead bushing, remove the wheel from the spindle and scrape the inside of the bushing (Fig. 539). Enough metal must be scraped from the hole to allow the wheel to slip freely over the spindle.
12. Clean and replace the outer flange on the grinder spindle, and replace the nut on the spindle end (Fig. 541).
13. Use a cloth or a glove to protect the hand when the wheel is being held.
14. Hold the wheel securely with the one hand and tighten the nut with a wrench held in the other (Fig. 542). The nut must be tight enough to hold the wheel, but not tight enough to crush it.

NOTE: The pressure exerted at the center of the flange by the nut is applied at a greater distance from the center of the wheel by the outer edge of the flange. For this reason, it is not necessary to tighten the nut with the same amount of force as would be required if the wheel were held by a small surface such as a washer near the center of the wheel.

15. Replace the side of the guard (Fig. 543).
16. Mount the wheel on the left side of the grinder.

NOTE: Observe that in order to tighten the nuts, they must be turned in a direction opposite to the rotation of the spindle. Refer also to the description on page 311.

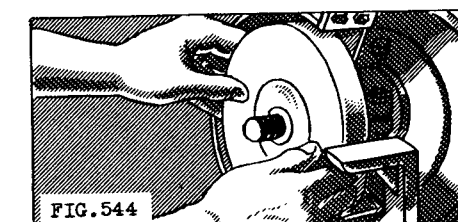
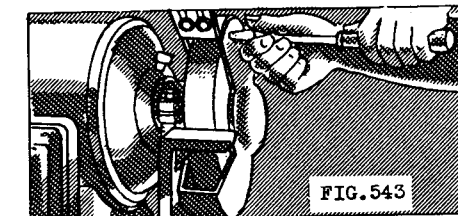
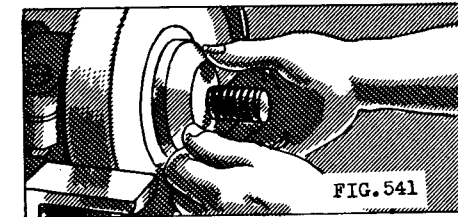
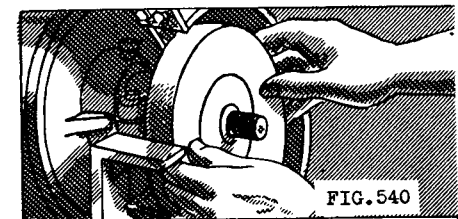
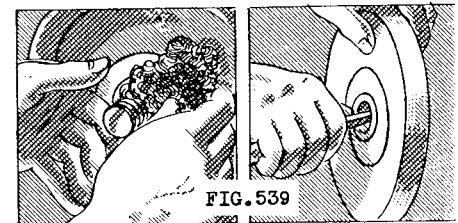
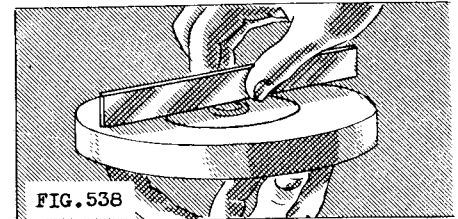

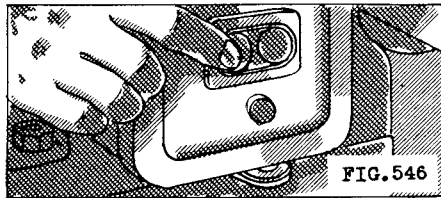
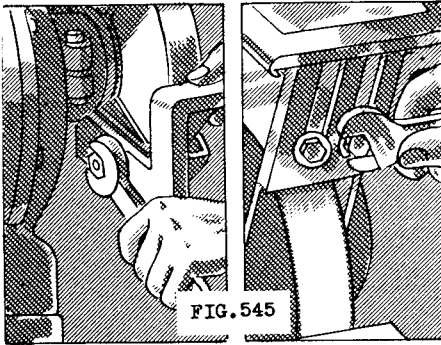

17. Adjust the tool rests and the spark breakers as near to the wheels as possible without touching the wheels (Fig. 545).

CAUTION Be certain that all adjustments are properly made and that the guards are securely in place before starting the machine.

18. Stand clear of the grinder and start the machine.
19. Observe the wheels, and, if they run out, have them trued by the instructor.
20. Finally, check the adjustment of the spark breakers, the tool rests, and the safety-glass shields.

HOW TO ADJUST THE GRINDER PRIOR TO OPERATING

1. Be certain that the grinder is properly lubricated. Follow the manufacturer's instructions or use one of the following procedures.

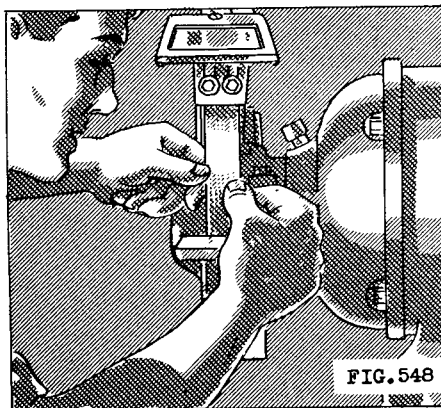
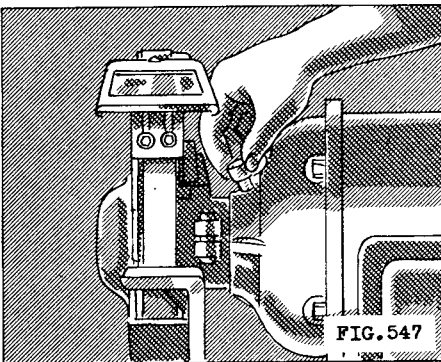

- a. When the grinder is provided with oil holes, oil the grinder daily.
 - b. When the grinder is provided with oil or grease cups, fill them regularly with oil or grease.
 - c. When the grinder is provided with sealed ball bearings, grease the bearings every six months.
2. Observe the condition of the wheels. The faces should be straight and square with the wheels. The grains in the wheel faces must be sharp and not glazed, and the spaces between the grains must be free of ground material.
 3. Stand to one side of the grinder, start the machine, and observe whether or not the wheels are running true.
 4. Decide whether the wheels need truing or dressing. If the wheels need truing, consult the instructor; if the wheels need dressing, proceed as instructed on page 321.

5. Examine the tool rests and make certain that they are set at the required heights, that they are set as close as possible to the wheels without touching, and that the rests are securely fastened in position (Fig. 545).
6. Inspect the position of the spark breakers and, if necessary, adjust the edge of the breakers as near to the faces of the wheels as possible (Fig. 545).
7. Adjust the safety-glass shields on the grinder to permit a clear vision of the part to be ground and, at the same time, to protect the operator from flying particles (Fig. 549).

CAUTION Wear goggles if the grinder is not equipped with safety-glass shields. Each person should use his own individual goggles as a precaution against the spread of eye diseases and skin infections (Fig. 550).

HOW TO DRESS A GRINDING WHEEL

1. Select a suitable dressing tool from those that are available.

NOTE: Two of the common types of wheel dressers are the abrasive-stick type (Fig. 551) and the star-wheel type (Fig. 552). Usually the star-wheel type with hardened steel circular discs which revolve when pressed against the wheel, is the one most frequently used. The points of the discs tend to pick the metal out of the wheel without dislodging too much of the abrasive from the face.

2. Adjust the glass shields on the machine so that the dressing process can be plainly observed (Fig. 553).
3. Use goggles as an additional protection for the eyes.
4. Use coveralls or a shop coat to keep the dust from the clothing (Fig. 554). (Exhaust outlets are provided on the newer bench and floor grinders; this indicates that the use of exhaust systems for all types of grinding is steadily becoming standard practice.) If

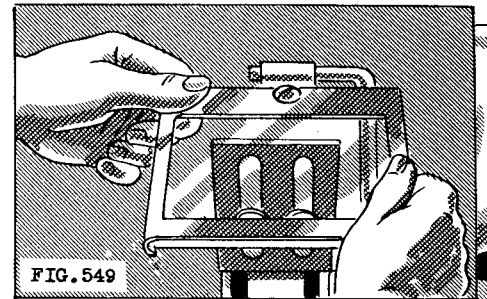

FIG. 549

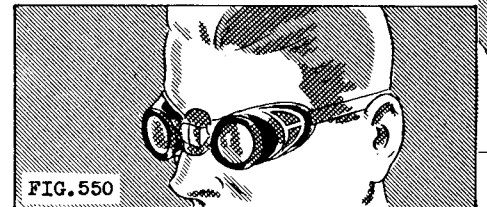

FIG. 550

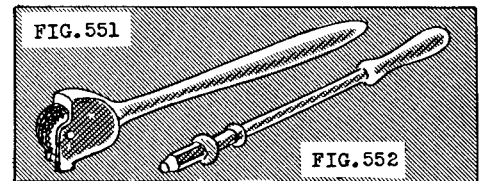

FIG. 551

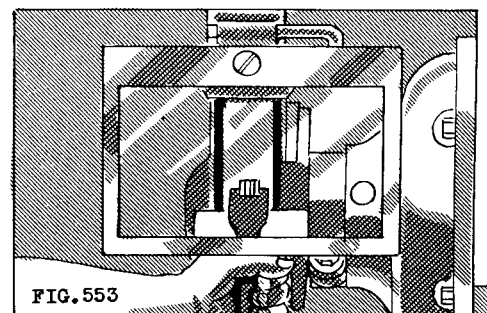

FIG. 553

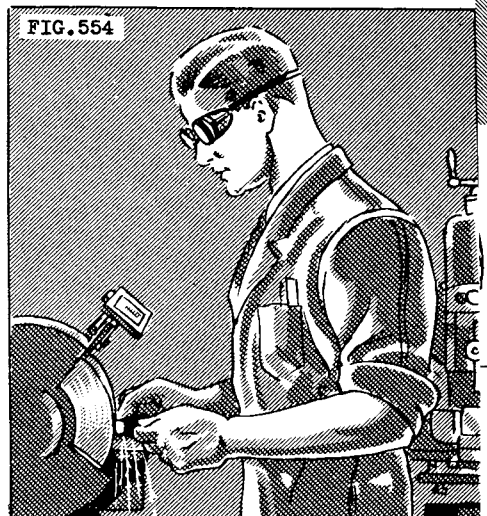

FIG. 554

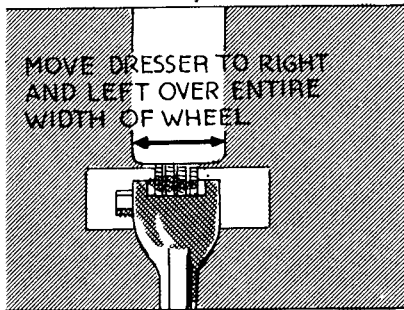

FIG. 555

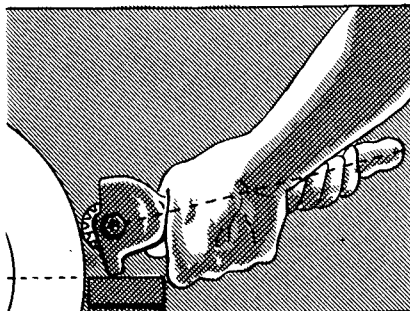

FIG. 556

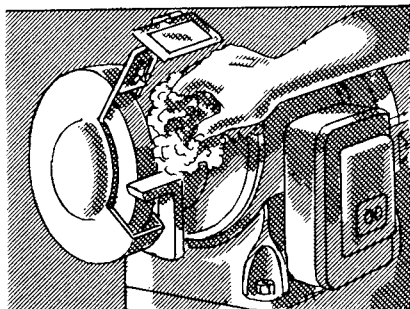

FIG. 557

no exhaust system is used and much dressing has to be done, a respirator may be worn to prevent inhalation of dust.

5. Support the dresser on the tool rest and, if necessary, adjust the height of the tool rest until the point of contact of the dresser is slightly above the center of the grinding wheel. The purpose of this is to prevent the dresser from being drawn into the wheel (Fig. 556).
6. Start the grinder.
7. "Cant" the dresser slightly upward to prevent chatter. Chatter is caused by the tendency of the revolving wheel to force the dresser away from the wheel face and the inability of the hand to maintain an even pressure against the wheel (Fig. 556).
8. Slowly press the dresser against the face of the revolving wheel until it "bites." Then, move the dressing tool back and forth across the wheel to obtain a straight surface. Hold the dresser rigidly to retain the trueness of the wheel when the face is being dressed (Fig. 555).
9. Stop the machine; brush the dust from the machine and clean the safety-glass eye shields; then, finally, check the adjustment of the tool rests. Refer to step No. 5 on page 321.

HOW TO GRIND SHAPER TOOLS

HOW TO GRIND A LEFT-CUT ROUGHING TOOL

GRINDING THE SIDE RELIEF, OR SIDE CLEARANCE

1. Read the description of tools on page 157 in order to become familiar with the shapes and the terminology of shaper tools.
2. Prepare the tool grinder as instructed on page 320.

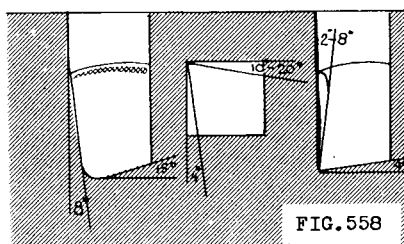

FIG. 558

3. Observe the shape, the angles, and the clearances of the left-cut tool as illustrated in Fig. 558. The angles and clearances are for tools whose bases are held at 90° to the surface being machined. In this case, the tool is held parallel to the base of the tool

holder. (Refer to page 154 for the description of tool holders.)

4. Start the grinder.

CAUTION Stand to one side before starting the grinder.

5. Use the coarse wheel for rough grinding the tool.
6. Hold the tool bit in the right hand and support it with the left hand (Fig. 559).
7. Hold the tool at an angle of about 8° with the face of the wheel to give the necessary side-cutting-edge angle (Fig. 559) and, at the same time, tip the top of the tool outwards from the wheel to produce a side relief, or side clearance, of about 4° (Fig. 560).
8. Press the tool firmly against the wheel and move it back and forth across its face. The purpose of the back-and-forth movement is to wear down evenly the whole width of the face of the wheel.
9. Cool the tool by immersing it in the water pot when it becomes quite warm to the touch.

NOTE: An experienced operator is able to judge with a fair degree of accuracy the shapes, angles, and clearances for tool grinding. The inexperienced operator, on the other hand, should have some method of checking them. Either a correctly shaped tool with the proper angles and clearances may be used for comparing the angles, or the tool angles may be checked with a protractor or a bevel gage which has been set and compared with a protractor.

10. Place the tool and the pattern together and by observation check the ground angle of the tool with that of the pattern (Fig. 560), or check with a protractor set at the correct side-relief angle (Fig. 561).

11. Correct the side-relief angle when the tool is being ground by increasing the pressure with the fingers toward the top if the clearance is too much, and by increasing the pressure toward the bottom if the clearance is insufficient. This

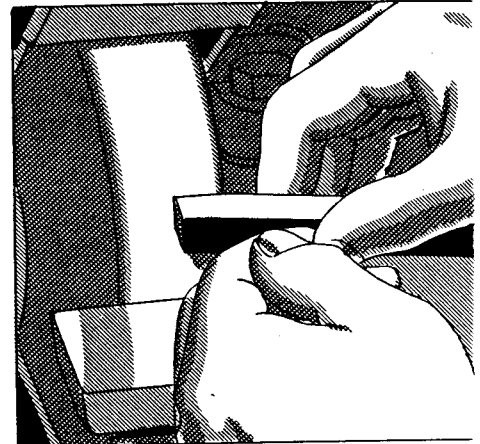

FIG. 559

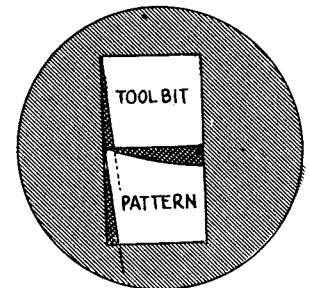

FIG. 560

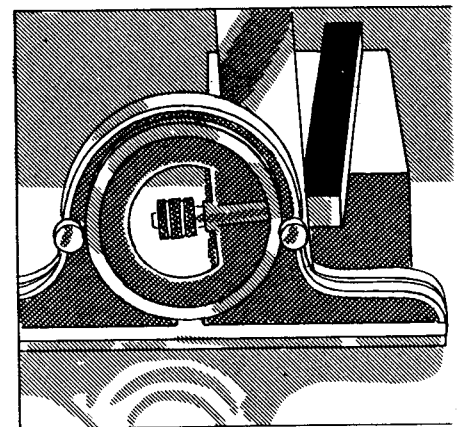
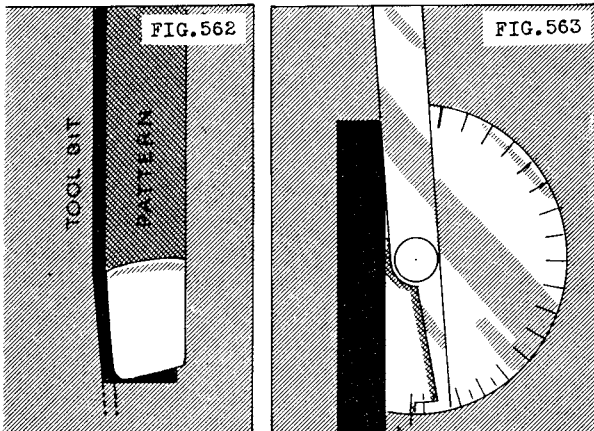

FIG. 561



ability, when the tool is being ground, to judge where the pressure is being applied in order to change the shape or to modify the tool angles, is acquired after a little practice and is called the "feel" of the wheel.

- Continue grinding until the angle and the length of the ground side compare with those of the pattern (Fig. 562), or check with a protractor (Fig. 563).

GRINDING THE END RELIEF OR END CLEARANCE

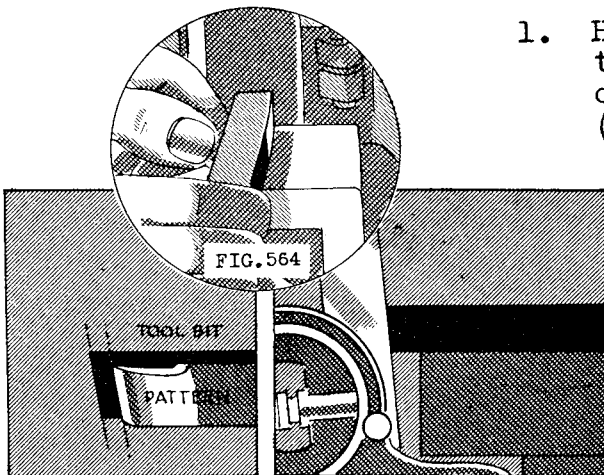

- Hold the tool at an angle of about 75° to the face of the wheel and incline the front of the tool upward at an angle of about 4° (Fig. 564).

- Press the tool firmly against the wheel, and, at the same time, move the tool back and forth across the entire face of the wheel.

- Check by observation the end-relief angle by placing the pattern in front of the tool (Fig. 565), or by using a protractor as illustrated in Fig. 566.

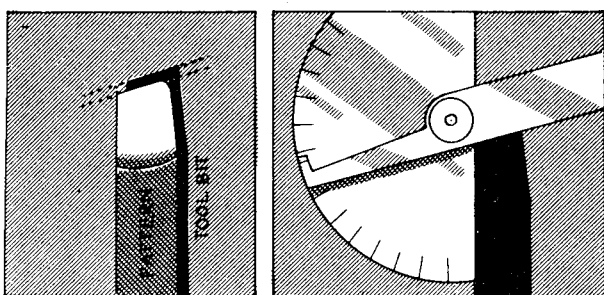

- Check the end-cutting-edge angle by placing the pattern on top of the tool (Fig. 567), or by using a protractor as illustrated in Fig. 568.

- Continue grinding the tool until the end-cutting-edge angle is ground to the proper length and to the desired angle. At the same time be certain that the end-relief angle is correct.

CAUTION A tool should be ground carefully because no more metal than is absolutely necessary should be ground away. Unnecessary grinding wastes valuable time and expensive material.

GRINDING THE SIDE AND BACK RAKE

- Hold the face of the tool at an angle of

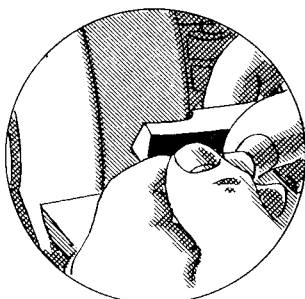
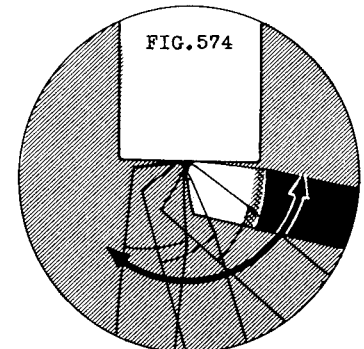
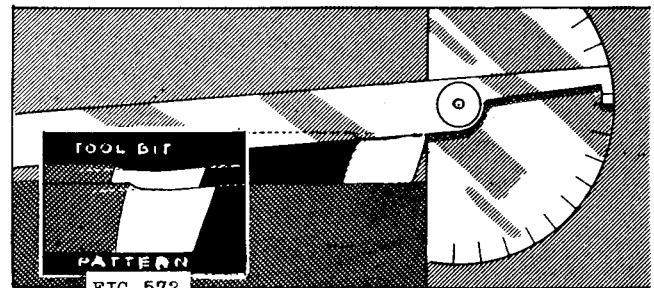
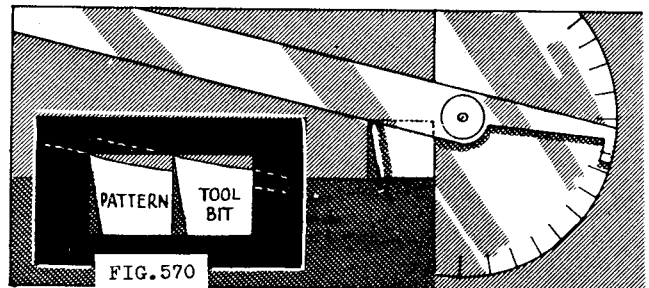

FIG. 569

about 2° to 8° with the face of the wheel, and, at the same time, tip the tool forward to obtain a side slope of 10° to 20° (Fig. 569).

2. Press the tool firmly against the wheel and grind the face of the tool.
3. Place the tool and the pattern together as shown in Fig. 570 and compare the side slope of the tool with that of the pattern, or use a protractor as shown in Fig. 571.
4. Compare also the back slope of the tool with that of the pattern (Fig. 572), or check it with a protractor (Fig. 573).
5. Compensate for any inaccuracy of the side rake by applying slightly more pressure to the top or to the bottom of the tool, whichever is necessary, and, at the same time, correct any inaccuracy of the back rake by increasing the pressure either at the point or at the opposite end.
6. Continue to grind the face of the tool, checking occasionally as the grinding proceeds, until the cutting edge is sharp.



GRINDING THE RADIUS ON THE NOSE OF THE TOOL

1. To grind the radius on the nose of the tool, hold the tool lightly against the wheel, and, while the nose is in contact with the wheel, swing the tool from side to side (Fig. 574). When the desired radius has been obtained, finish grind on the fine wheel the whole area of the point of the tool.

STONING THE TOOL

There are two equally effective methods of stoning the tool which are commonly practiced. Some machinists prefer to rub the tool over the sharpening stone; others find it more convenient to rub the stone over the tool. The following instructions and illustrations show both methods. Whichever method is used, be certain to keep the surface of the tool flat against the stone to prevent rounding of the cutting edges.

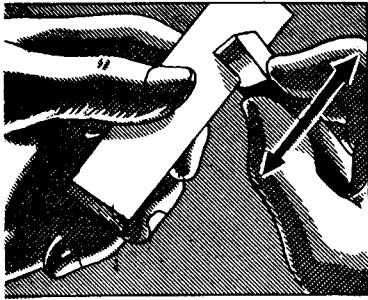

FIG. 575

1. Hold the sharpening or abrasive stone in one hand and rub the tool from side to side until the cutting edge on the face of the tool is smooth (Fig. 575), or hold the tool in the hand and rub the stone over the tool (Fig. 576).

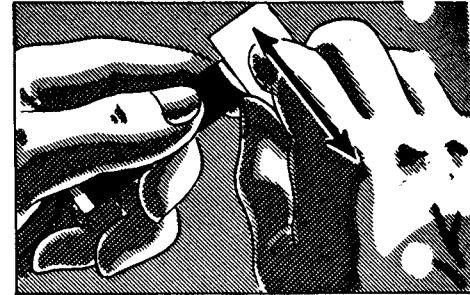

FIG. 576

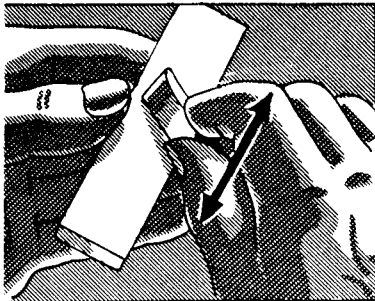

FIG. 577

2. Rub the flank of the tool on the stone (Fig. 577) until the cutting edge on the side is smooth, or rub the stone over the flank of the tool (Fig. 578).

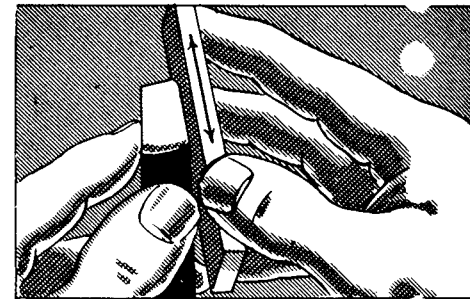

FIG. 578

3. Stone the end of the tool by holding it at a slight angle to the vertical position (Fig. 579) and by rubbing it on the stone until the top edge is smooth, or hold the tool stationary and smooth the edge with the stone (Fig. 580).

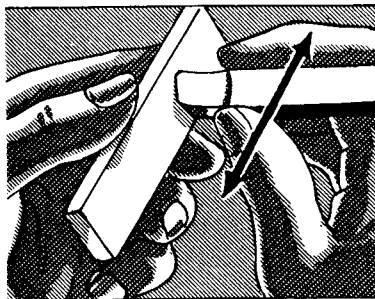

FIG. 579

4. Stone the nose of the tool by holding the tool as illustrated in Fig. 581. Rub the tool back and forth over the stone and at the same time swivel the tool to produce a circular motion at the nose, or move the stone with a circular motion around the nose of the tool (Fig. 582).

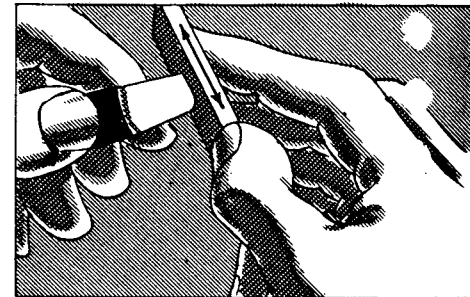

FIG. 580

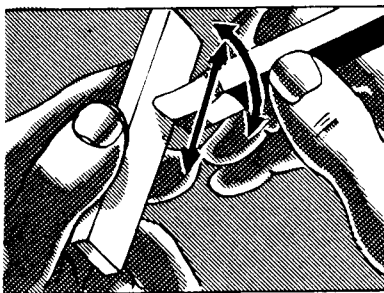

FIG. 581

5. Examine the cutting edge of the tool. Now, if it is properly stoned, the wheel marks will be eliminated at the cutting edge and it will be keen and smooth. It should be noticed that the curve of the wheel causes the ground surfaces to be slightly hollow. This is an advantage when the tool is being stoned, for under these conditions the tendency to round the edges is greatly lessened.

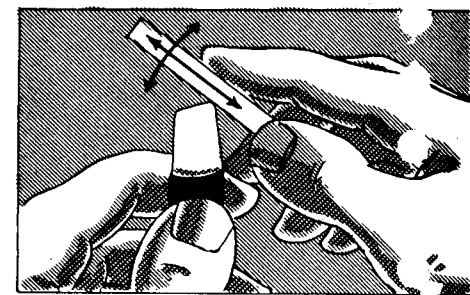

FIG. 582